



MCH4020 — NPN Epitaxial Planar Silicon Transistor

High Frequency Low-Noise Amplifier

Features

- Low-noise use : NF=1.2dB typ (f=1GHz)
- High cut-off frequency : $f_T=16\text{GHz}$ typ ($V_{CE}=5\text{V}$)
- High gain : $|S_{21e}|^2=17.5\text{dB}$ typ (f=1GHz)
- Halogen free compliance

Specifications

Absolute Maximum Ratings at $T_a=25^\circ\text{C}$

Parameter	Symbol	Conditions	Ratings	Unit
Collector-to-Base Voltage	V_{CBO}		15	V
Collector-to-Emitter Voltage	V_{CEO}		8	V
Emitter-to-Base Voltage	V_{EBO}		2	V
Collector Current	I_C		150	mA
Collector Dissipation	P_C		400	mW
Junction Temperature	T_j		150	$^\circ\text{C}$
Storage Temperature	T_{stg}		-55 to +150	$^\circ\text{C}$

Package Dimensions

unit : mm (typ)
7020A-002

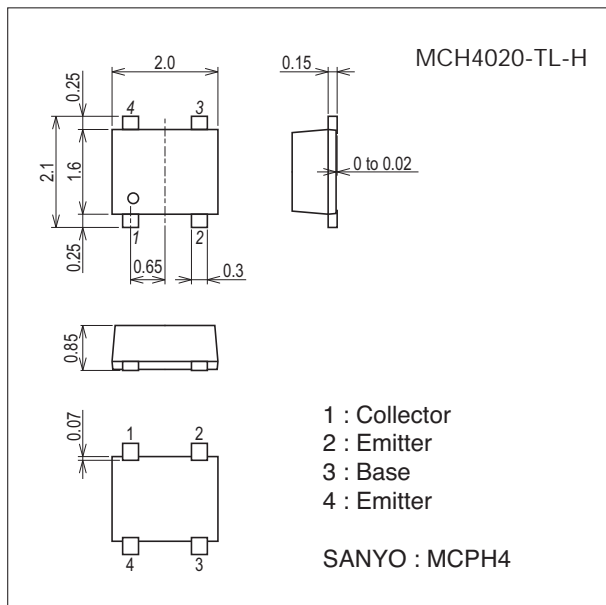

Product & Package Information

- Package : MCPH4
- JEITA, JEDEC : SC-82, SC-82AB, SOT-343
- Minimum Packing Quantity : 3,000 pcs./reel

Packing Type : TL

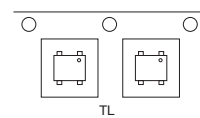

Marking

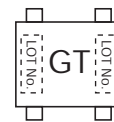

Electrical Connection

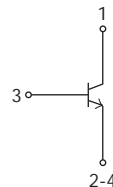

MCH4020

Electrical Characteristics at Ta=25°C

Parameter	Symbol	Conditions	Ratings			Unit
			min	typ	max	
Collector Cutoff Current	I_{CBO}	$V_{CB}=5V, I_E=0A$			1.0	μA
Emitter Cutoff Current	I_{EBO}	$V_{EB}=1V, I_C=0A$			1.0	μA
DC Current Gain	h_{FE}	$V_{CE}=5V, I_C=50mA$	60		150	
Gain-Bandwidth Product	f_T	$V_{CE}=5V, I_C=50mA$	13	16		GHz
Forward Transfer Gain	$ S_{21e} ^2$	$V_{CE}=5V, I_C=50mA, f=1GHz$		17.5		dB
Noise Figure	NF	$V_{CE}=1V, I_C=10mA, f=1GHz$		1.2	1.8	dB

Note) Pay attention to handling since it is liable to be affected by static electricity due to the high-frequency process adopted.

Ordering Information

Device	Package	Shipping	memo
MCH4020-TL-H	MCPH4	3,000pcs./reel	Pb Free and Halogen Free

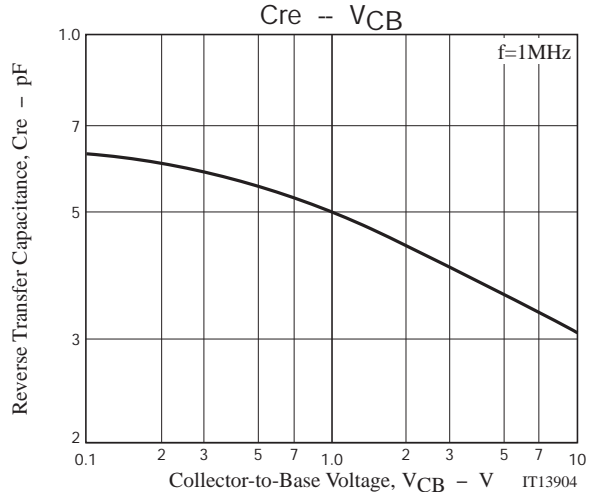
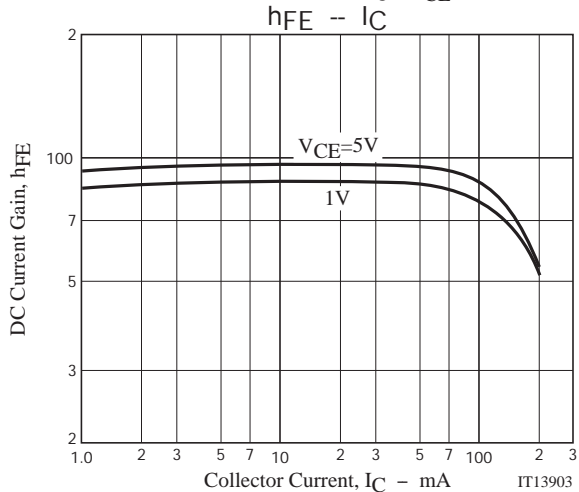
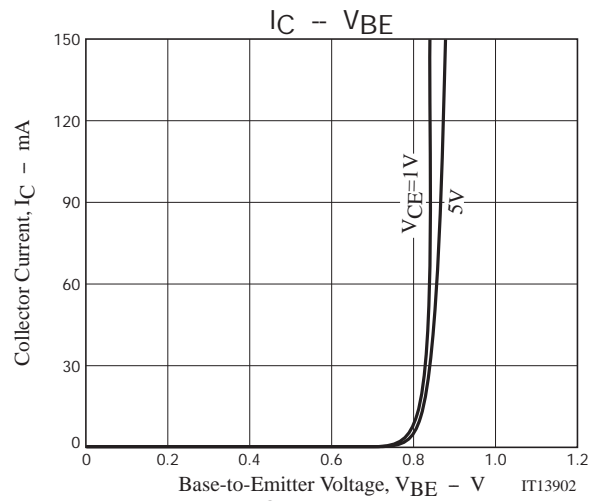
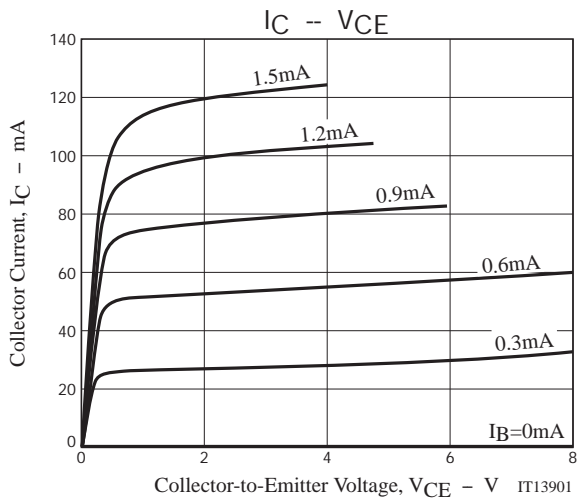

MCH4020

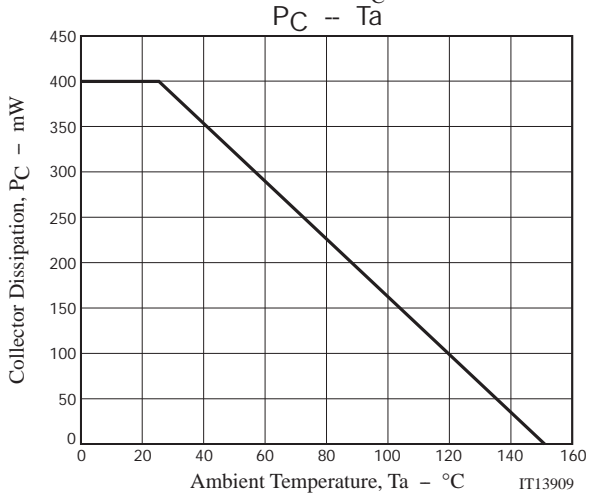
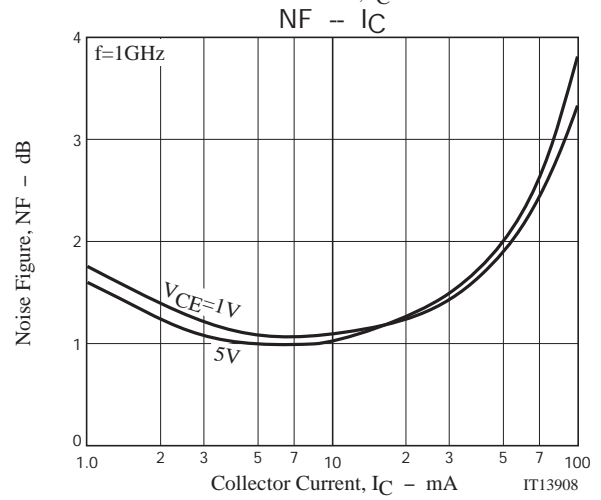
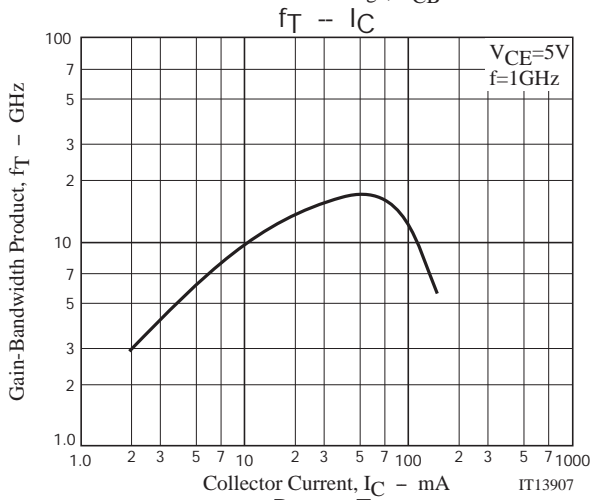
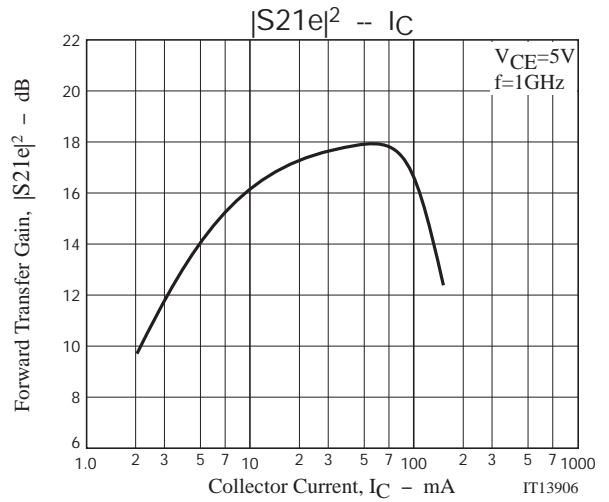
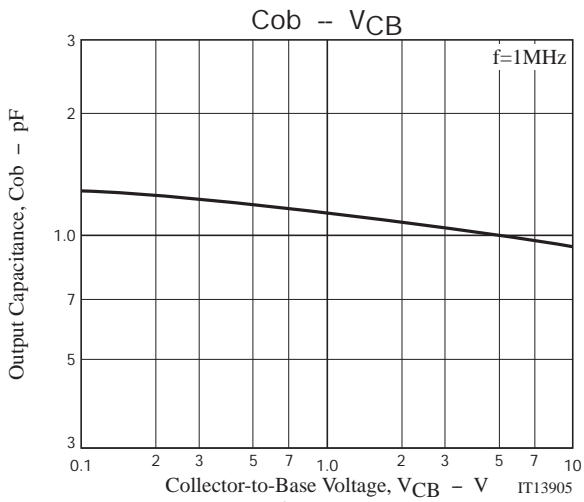

MCH4020

SPICE Parameters

model: Gummel-Poon

Parameter	Value	Unit	Parameter	Value	Unit
IS	2.155f	A	TF	6.700p	S
BF	122		XTF	50.00f	
NF	1.05		VTF	750.0m	V
VAF	8	V	ITF	50	A
IKF	206.4m	A	PTF	200.0m	°C
ISE	1.384p	A	CJC	175.0f	F
NE	2.278		VJC	200.0f	V
BR	14		MJC	1.150p	
NR	1.042		XCJC	1	
VAR	4	V	TR	0	S
IKR	360.0m	A	FC	500.0m	
ISC	140.0f	A	CJS	550.0f	F
NC	1.6		VJS	150.0m	V
RB	2	Ω	MJS	136.0m	
IRB	1.5	A	Lfc	110.0p	H
RBM	25.00m	Ω	Lwb	850.0p	H
RE	450.0m	Ω	Lfb	73.0p	H
RC	1.2	Ω	Lwe	145.0p	H
XTB	0		Lfe	280.0p	H
EG	1.11	eV	Cbc	325.0f	F
XTI	1		Ceb	175.0f	F
CJE	2.476p	F	Cce	120.0f	F
VJE	750.0m	V			
MJE	10.00m				

Schematic

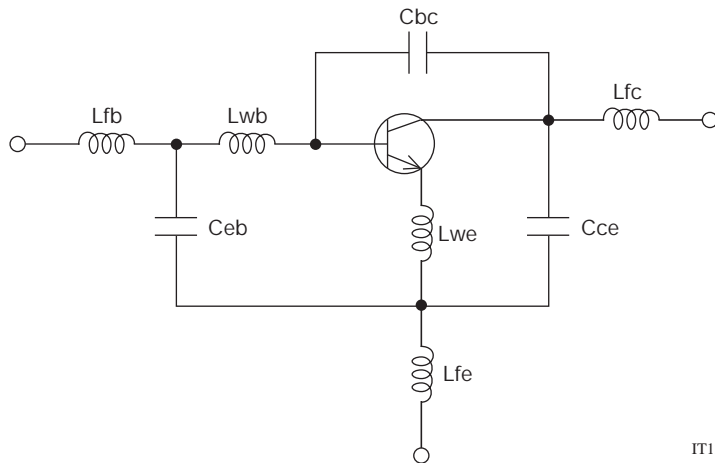

*Information (including circuit diagrams and circuit parameters) herein is for example only ; it is not guaranteed for volume production.

MCH4020

S Parameters (Common emitter)

V_{CE}=1V, I_C=10mA

Freq(MHz)	S ₁₁	∠S ₁₁	S ₂₁	∠S ₂₁	S ₁₂	∠S ₁₂	S ₂₂	∠S ₂₂
200	0.664	-88.0	17.728	131.6	0.046	52.6	0.753	-60.7
400	0.674	-130.4	11.682	107.8	0.061	40.5	0.567	-93.8
600	0.681	-147.2	8.523	95.7	0.071	38.0	0.513	-106.8
800	0.666	-160.0	6.411	87.9	0.076	38.4	0.445	-118.0
1000	0.658	-168.7	5.131	82.2	0.082	39.7	0.414	-126.1
1200	0.657	-175.3	4.280	77.4	0.087	41.3	0.393	-132.2
1400	0.657	179.2	3.679	73.1	0.093	42.8	0.382	-136.8
1600	0.657	174.3	3.228	69.2	0.100	44.4	0.375	-141.0
1800	0.658	170.2	2.878	65.5	0.107	45.5	0.372	-143.9
2000	0.659	166.6	2.608	62.0	0.114	46.5	0.372	-146.8
2200	0.657	162.8	2.379	58.7	0.122	47.2	0.374	-149.0
2400	0.658	159.4	2.193	55.3	0.130	47.6	0.378	-151.2
2600	0.657	156.0	2.041	52.2	0.138	47.8	0.384	-153.4
2800	0.657	152.7	1.909	49.0	0.146	47.9	0.390	-154.6
3000	0.655	149.4	1.793	46.0	0.155	47.8	0.399	-156.0
3200	0.652	146.0	1.693	42.9	0.163	47.5	0.409	-157.2
3400	0.652	142.6	1.605	39.9	0.172	47.1	0.419	-158.1
3600	0.651	139.0	1.528	37.1	0.180	46.6	0.432	-158.9
3800	0.650	135.6	1.456	34.2	0.189	45.8	0.443	-159.6
4000	0.650	131.8	1.393	31.3	0.198	45.0	0.455	-160.2
4200	0.650	128.2	1.337	28.6	0.206	44.2	0.467	-160.8
4400	0.652	124.6	1.281	26.0	0.215	43.3	0.479	-161.2
4600	0.653	120.8	1.233	23.5	0.224	42.2	0.489	-161.5
4800	0.654	117.3	1.185	20.8	0.232	41.1	0.499	-161.7
5000	0.656	113.8	1.147	18.4	0.240	40.0	0.508	-162.1

V_{CE}=1V, I_C=50mA

Freq(MHz)	S ₁₁	∠S ₁₁	S ₂₁	∠S ₂₁	S ₁₂	∠S ₁₂	S ₂₂	∠S ₂₂
200	0.652	-152.6	22.719	111.2	0.024	50.4	0.545	-102.4
400	0.694	-168.0	12.745	95.1	0.034	54.6	0.466	-133.3
600	0.693	-174.1	8.865	86.6	0.045	58.6	0.442	-140.7
800	0.694	179.3	6.618	81.7	0.055	61.5	0.422	-149.5
1000	0.693	174.3	5.279	77.7	0.066	63.1	0.415	-154.8
1200	0.697	170.1	4.399	74.2	0.078	64.0	0.410	-159.2
1400	0.698	166.3	3.771	70.8	0.089	64.0	0.407	-162.2
1600	0.700	162.8	3.307	67.7	0.100	63.8	0.405	-165.0
1800	0.700	159.6	2.961	64.7	0.111	63.3	0.403	-167.1
2000	0.700	156.8	2.683	61.8	0.122	62.7	0.405	-169.1
2200	0.699	153.5	2.457	59.0	0.134	61.8	0.407	-170.8
2400	0.699	150.5	2.260	56.0	0.145	60.6	0.410	-172.2
2600	0.696	147.6	2.105	53.2	0.156	59.4	0.413	-173.6
2800	0.696	144.6	1.976	50.5	0.167	58.2	0.416	-174.4
3000	0.692	141.5	1.861	47.8	0.177	56.8	0.422	-175.4
3200	0.688	138.3	1.761	45.0	0.188	55.4	0.429	-175.9
3400	0.687	135.0	1.674	42.3	0.198	53.8	0.433	-176.3
3600	0.684	131.6	1.598	39.7	0.209	52.4	0.441	-176.5
3800	0.681	128.3	1.526	37.0	0.219	50.8	0.448	-176.6
4000	0.680	124.7	1.462	34.3	0.229	49.2	0.456	-176.6
4200	0.679	121.2	1.403	31.7	0.239	47.5	0.463	-176.6
4400	0.678	117.7	1.351	29.3	0.248	46.0	0.470	-176.4
4600	0.678	114.1	1.305	26.8	0.257	44.3	0.476	-176.2
4800	0.676	110.7	1.260	24.3	0.266	42.5	0.480	-176.1
5000	0.676	107.4	1.224	22.0	0.274	40.9	0.485	-176.0

MCH4020

S Parameters (Common emitter)

V_{CE}=1V, I_C=100mA

Freq(MHz)	S ₁₁	∠S ₁₁	S ₂₁	∠S ₂₁	S ₁₂	∠S ₁₂	S ₂₂	∠S ₂₂
200	0.797	-170.2	11.994	103.3	0.023	46.0	0.462	-142.7
400	0.821	-178.6	6.267	90.3	0.032	55.8	0.471	-159.7
600	0.814	176.9	4.334	82.5	0.044	60.5	0.456	-162.5
800	0.816	172.4	3.254	78.0	0.056	63.5	0.453	-167.1
1000	0.815	168.6	2.616	73.9	0.068	65.0	0.452	-169.7
1200	0.819	165.2	2.196	70.2	0.080	65.6	0.452	-172.2
1400	0.819	162.0	1.895	66.7	0.092	65.4	0.452	-173.8
1600	0.821	158.9	1.674	63.1	0.104	64.8	0.453	-175.5
1800	0.821	155.9	1.516	59.9	0.116	64.3	0.451	-177.0
2000	0.821	153.3	1.378	56.8	0.128	63.4	0.455	-178.3
2200	0.819	150.2	1.270	53.8	0.140	62.4	0.458	-179.4
2400	0.818	147.4	1.178	50.7	0.152	61.1	0.462	179.5
2600	0.815	144.6	1.107	47.7	0.164	59.7	0.464	178.3
2800	0.814	141.6	1.048	44.9	0.176	58.3	0.469	177.7
3000	0.809	138.5	0.995	42.2	0.187	56.9	0.475	176.9
3200	0.805	135.5	0.949	39.4	0.198	55.3	0.481	176.5
3400	0.803	132.2	0.909	36.7	0.209	53.8	0.486	176.1
3600	0.799	128.9	0.875	34.2	0.221	52.2	0.493	175.9
3800	0.796	125.6	0.842	31.6	0.232	50.5	0.499	175.7
4000	0.794	122.1	0.812	29.1	0.242	48.7	0.505	175.6
4200	0.792	118.7	0.785	26.7	0.252	47.0	0.511	175.6
4400	0.790	115.3	0.762	24.5	0.262	45.3	0.516	175.7
4600	0.788	111.8	0.743	22.3	0.272	43.4	0.519	175.8
4800	0.787	108.3	0.722	20.0	0.281	41.6	0.522	175.8
5000	0.785	105.1	0.707	17.9	0.290	39.9	0.525	175.8

V_{CE}=3V, I_C=10mA

Freq(MHz)	S ₁₁	∠S ₁₁	S ₂₁	∠S ₂₁	S ₁₂	∠S ₁₂	S ₂₂	∠S ₂₂
200	0.667	-73.4	19.421	137.2	0.036	59.5	0.807	-46.2
400	0.654	-117.7	13.670	112.4	0.051	46.8	0.610	-74.6
600	0.657	-137.3	10.173	99.3	0.060	43.7	0.541	-86.7
800	0.635	-152.0	7.684	90.5	0.066	43.4	0.452	-96.5
1000	0.624	-162.0	6.158	84.2	0.071	44.2	0.407	-104.3
1200	0.621	-169.6	5.138	79.1	0.076	45.7	0.376	-110.1
1400	0.620	-175.7	4.400	74.5	0.082	47.0	0.360	-114.7
1600	0.619	178.9	3.867	70.4	0.088	48.7	0.347	-119.0
1800	0.620	174.4	3.431	66.7	0.095	49.8	0.343	-122.2
2000	0.621	170.6	3.103	63.0	0.101	50.9	0.341	-125.5
2200	0.620	166.6	2.828	59.5	0.108	51.7	0.343	-128.1
2400	0.621	163.0	2.602	56.1	0.116	52.3	0.347	-130.7
2600	0.620	159.4	2.419	52.9	0.124	52.6	0.353	-133.3
2800	0.622	156.1	2.253	49.6	0.131	52.8	0.361	-135.1
3000	0.620	152.7	2.112	46.5	0.139	52.8	0.372	-137.1
3200	0.618	149.2	1.990	43.3	0.148	52.6	0.384	-138.9
3400	0.619	145.6	1.881	40.3	0.156	52.3	0.396	-140.4
3600	0.618	142.1	1.784	37.3	0.164	51.9	0.412	-141.7
3800	0.618	138.5	1.696	34.3	0.173	51.2	0.426	-143.0
4000	0.618	134.7	1.618	31.4	0.182	50.5	0.441	-144.1
4200	0.620	130.9	1.549	28.6	0.191	49.6	0.456	-145.3
4400	0.621	127.2	1.480	25.9	0.199	48.7	0.471	-146.2
4600	0.623	123.4	1.419	23.2	0.208	47.7	0.485	-147.0
4800	0.626	119.8	1.359	20.5	0.216	46.7	0.498	-147.7
5000	0.629	116.2	1.309	18.0	0.224	45.6	0.511	-148.5

MCH4020

S Parameters (Common emitter)

V_{CE}=3V, I_C=50mA

Freq(MHz)	S ₁₁	∠S ₁₁	S ₂₁	∠S ₂₁	S ₁₂	∠S ₁₂	S ₂₂	∠S ₂₂
200	0.516	-135.8	31.907	119.4	0.020	59.2	0.602	-73.9
400	0.593	-158.7	17.954	99.0	0.029	60.4	0.444	-104.5
600	0.602	-166.8	12.350	89.5	0.039	63.6	0.404	-113.3
800	0.606	-174.8	9.160	83.7	0.049	65.9	0.359	-123.7
1000	0.608	179.2	7.261	79.3	0.059	67.0	0.341	-131.0
1200	0.612	174.4	6.025	75.7	0.069	67.5	0.327	-136.6
1400	0.614	170.2	5.149	72.2	0.079	67.4	0.321	-140.6
1600	0.615	166.4	4.503	69.0	0.089	67.2	0.316	-144.0
1800	0.618	162.9	4.004	66.0	0.100	66.4	0.314	-146.9
2000	0.619	159.8	3.619	63.1	0.110	65.8	0.316	-149.3
2200	0.618	156.5	3.299	60.1	0.120	64.9	0.319	-151.3
2400	0.618	153.5	3.035	57.3	0.130	63.9	0.322	-152.9
2600	0.617	150.5	2.816	54.4	0.141	62.7	0.326	-154.5
2800	0.617	147.4	2.630	51.7	0.150	61.6	0.334	-155.5
3000	0.614	144.2	2.469	49.0	0.160	60.3	0.342	-156.7
3200	0.611	141.0	2.328	46.1	0.170	58.9	0.351	-157.4
3400	0.611	137.6	2.204	43.4	0.180	57.5	0.360	-157.9
3600	0.609	134.3	2.095	40.7	0.189	56.1	0.372	-158.3
3800	0.608	130.8	1.995	38.0	0.199	54.7	0.383	-158.6
4000	0.606	127.2	1.906	35.3	0.209	53.1	0.395	-158.7
4200	0.607	123.6	1.824	32.6	0.218	51.5	0.407	-158.8
4400	0.607	120.1	1.749	30.1	0.226	49.9	0.419	-158.9
4600	0.607	116.5	1.681	27.6	0.235	48.3	0.430	-158.8
4800	0.608	113.0	1.616	25.0	0.243	46.8	0.440	-158.9
5000	0.608	109.6	1.560	22.6	0.251	45.2	0.450	-159.0

V_{CE}=3V, I_C=100mA

Freq(MHz)	S ₁₁	∠S ₁₁	S ₂₁	∠S ₂₁	S ₁₂	∠S ₁₂	S ₂₂	∠S ₂₂
200	0.577	-155.5	28.271	114.9	0.017	60.5	0.496	-77.8
400	0.645	-169.1	15.432	96.4	0.025	64.9	0.367	-105.8
600	0.649	-174.6	10.567	87.2	0.036	68.7	0.339	-111.9
800	0.656	179.3	7.841	81.8	0.046	70.5	0.306	-121.4
1000	0.658	174.4	6.227	77.4	0.056	71.3	0.295	-127.8
1200	0.663	170.4	5.172	73.6	0.066	71.6	0.287	-132.7
1400	0.666	166.8	4.421	70.1	0.076	71.2	0.285	-136.0
1600	0.668	163.4	3.860	66.9	0.087	70.6	0.285	-138.9
1800	0.671	160.2	3.443	63.7	0.097	69.8	0.287	-141.5
2000	0.672	157.5	3.108	60.7	0.107	69.1	0.292	-143.6
2200	0.671	154.3	2.835	57.5	0.118	68.1	0.297	-145.5
2400	0.672	151.4	2.606	54.5	0.128	67.0	0.304	-147.0
2600	0.671	148.6	2.419	51.5	0.139	65.7	0.311	-148.5
2800	0.671	145.6	2.260	48.7	0.148	64.4	0.321	-149.6
3000	0.669	142.6	2.122	45.9	0.159	63.1	0.332	-150.9
3200	0.665	139.5	2.001	42.9	0.169	61.7	0.345	-151.7
3400	0.666	136.2	1.895	40.1	0.179	60.2	0.357	-152.5
3600	0.664	132.9	1.800	37.3	0.189	58.6	0.371	-153.0
3800	0.663	129.5	1.713	34.5	0.199	57.1	0.385	-153.6
4000	0.662	126.0	1.635	31.7	0.209	55.5	0.399	-154.0
4200	0.663	122.5	1.562	29.0	0.218	53.9	0.414	-154.4
4400	0.663	119.1	1.497	26.4	0.227	52.3	0.428	-154.8
4600	0.663	115.5	1.438	23.9	0.236	50.6	0.441	-155.0
4800	0.664	112.0	1.381	21.3	0.245	48.9	0.453	-155.3
5000	0.664	108.7	1.333	18.9	0.253	47.3	0.464	-155.7

MCH4020

S Parameters (Common emitter)

V_{CE}=5V, I_C=10mA

Freq(MHz)	S ₁₁	∠S ₁₁	S ₂₁	∠S ₂₁	S ₁₂	∠S ₁₂	S ₂₂	∠S ₂₂
200	0.674	-68.7	19.895	138.9	0.032	61.8	0.826	-41.4
400	0.653	-112.8	14.318	114.0	0.047	49.2	0.632	-67.8
600	0.651	-133.4	10.744	100.5	0.057	45.9	0.560	-79.3
800	0.626	-148.8	8.133	91.4	0.062	45.3	0.466	-88.2
1000	0.613	-159.3	6.522	84.8	0.067	46.0	0.415	-95.5
1200	0.610	-167.2	5.440	79.6	0.072	47.5	0.382	-100.9
1400	0.607	-173.5	4.659	74.9	0.078	48.7	0.363	-105.3
1600	0.606	-179.1	4.091	70.7	0.084	50.5	0.349	-109.4
1800	0.608	176.2	3.630	66.9	0.090	51.6	0.344	-112.7
2000	0.609	172.2	3.280	63.2	0.096	52.7	0.341	-116.0
2200	0.608	168.1	2.988	59.7	0.103	53.5	0.343	-118.8
2400	0.608	164.5	2.749	56.2	0.110	54.2	0.347	-121.6
2600	0.608	160.9	2.553	52.9	0.118	54.6	0.353	-124.4
2800	0.610	157.5	2.377	49.6	0.125	54.9	0.361	-126.4
3000	0.607	154.0	2.225	46.5	0.133	54.9	0.372	-128.8
3200	0.606	150.5	2.095	43.2	0.141	54.9	0.385	-130.8
3400	0.607	146.9	1.979	40.2	0.150	54.6	0.398	-132.6
3600	0.607	143.3	1.875	37.1	0.158	54.2	0.414	-134.3
3800	0.607	139.7	1.780	34.1	0.167	53.6	0.430	-136.0
4000	0.608	135.9	1.697	31.1	0.175	52.9	0.446	-137.4
4200	0.610	132.0	1.623	28.3	0.184	52.1	0.461	-138.8
4400	0.612	128.3	1.549	25.5	0.193	51.1	0.477	-140.0
4600	0.613	124.5	1.484	22.8	0.202	50.1	0.492	-141.1
4800	0.617	120.7	1.419	20.0	0.210	49.1	0.507	-142.0
5000	0.620	117.1	1.364	17.5	0.218	48.0	0.520	-143.0

V_{CE}=5V, I_C=50mA

Freq(MHz)	S ₁₁	∠S ₁₁	S ₂₁	∠S ₂₁	S ₁₂	∠S ₁₂	S ₂₂	∠S ₂₂
200	0.489	-128.9	33.664	121.6	0.019	61.0	0.625	-65.5
400	0.568	-154.7	19.269	100.2	0.028	61.3	0.449	-94.0
600	0.579	-163.6	13.271	90.3	0.038	64.6	0.404	-102.5
800	0.583	-172.3	9.829	84.2	0.047	66.7	0.350	-112.6
1000	0.584	-178.7	7.784	79.6	0.056	67.8	0.325	-119.9
1200	0.589	176.2	6.443	75.8	0.066	68.5	0.308	-125.6
1400	0.591	171.8	5.505	72.3	0.076	68.4	0.300	-129.7
1600	0.593	167.9	4.817	69.1	0.085	68.1	0.295	-133.2
1800	0.595	164.3	4.280	66.0	0.095	67.6	0.292	-136.3
2000	0.596	161.2	3.857	63.1	0.105	67.0	0.294	-138.9
2200	0.596	157.8	3.517	60.1	0.115	66.1	0.296	-141.1
2400	0.596	154.7	3.234	57.2	0.124	65.1	0.300	-142.9
2600	0.595	151.7	3.000	54.3	0.134	63.9	0.306	-144.7
2800	0.596	148.5	2.799	51.5	0.144	62.8	0.313	-145.9
3000	0.593	145.4	2.625	48.7	0.154	61.6	0.323	-147.3
3200	0.591	142.2	2.472	45.9	0.163	60.2	0.334	-148.3
3400	0.591	138.8	2.340	43.1	0.173	59.0	0.344	-149.0
3600	0.589	135.4	2.221	40.4	0.182	57.7	0.358	-149.6
3800	0.589	131.9	2.114	37.6	0.191	56.2	0.371	-150.2
4000	0.588	128.3	2.017	34.9	0.201	54.6	0.385	-150.6
4200	0.588	124.7	1.929	32.2	0.209	53.1	0.399	-150.9
4400	0.589	121.1	1.847	29.6	0.218	51.7	0.412	-151.3
4600	0.590	117.5	1.773	27.1	0.227	50.1	0.426	-151.5
4800	0.590	113.9	1.702	24.4	0.235	48.6	0.438	-151.7
5000	0.592	110.6	1.642	22.0	0.243	47.0	0.450	-152.0

Embossed Taping Specification

MCH4020-TL-H

1. Packing Format

Package Name	Carrier Tape Type	Maximum Number of devices contained (pcs)			Packing format	
		Reel	Inner box	Outer box	Inner BOX (C-1)	Outer BOX (A-7)
MCPH4	MCP4	3,000	15,000	90,000	5 reels contained Dimensions:mm (external) 183×72×185	6 inner boxes contained Dimensions:mm (external) 440×195×210

Packing method

Reel label, Inner box label (unit:mm) Outer box label
 It is a label at the time of factory shipments. The form of a label may change in physical distribution process.

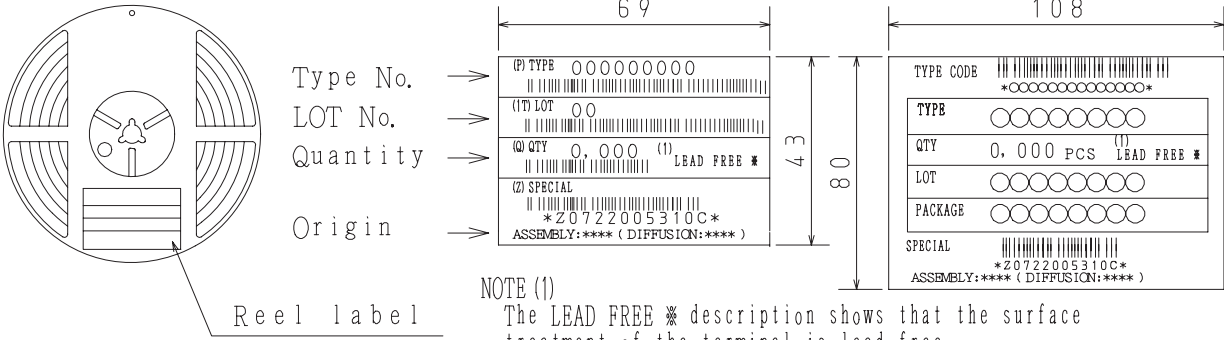

Label	JEITA Phase
LEAD FREE 3	JEITA Phase 3A
LEAD FREE 4	JEITA Phase 3

2. Taping configuration

2-1. Carrier tape size (unit:mm)

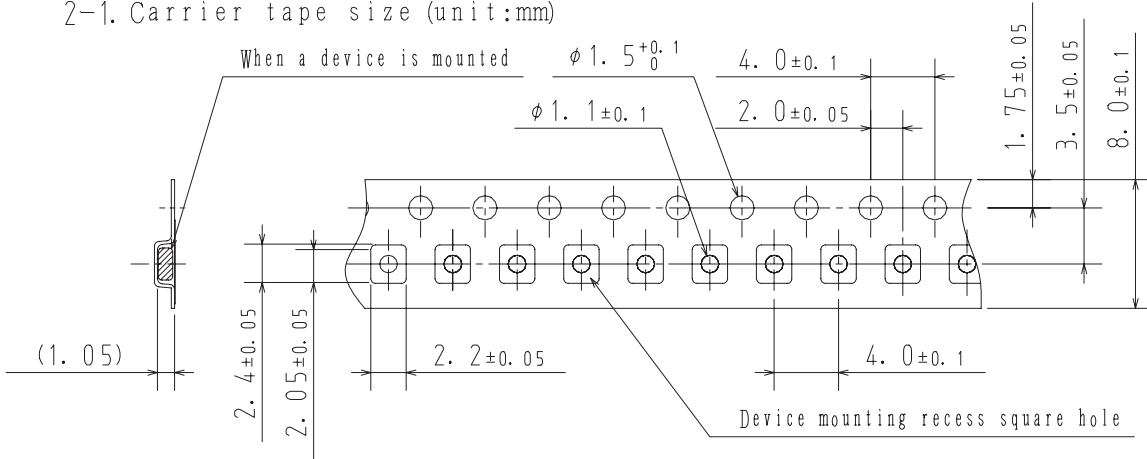

2-2. Device placement direction

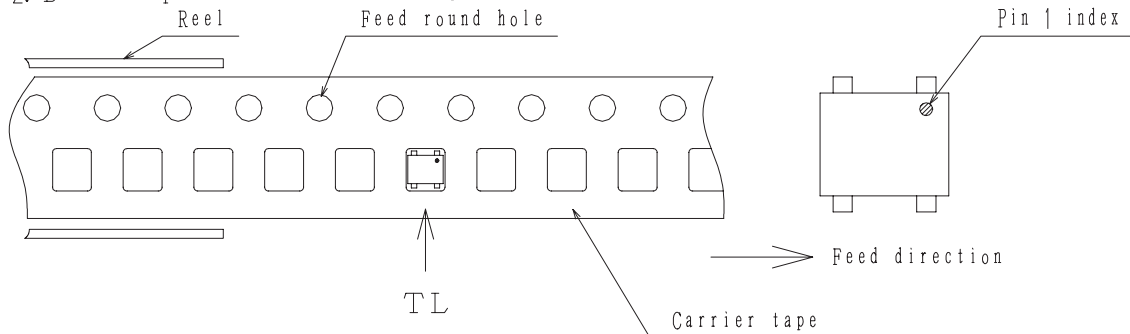

Those with pin 1 index on the feed hole side.....TL

MCH4020

Outline Drawing MCH4020-TL-H

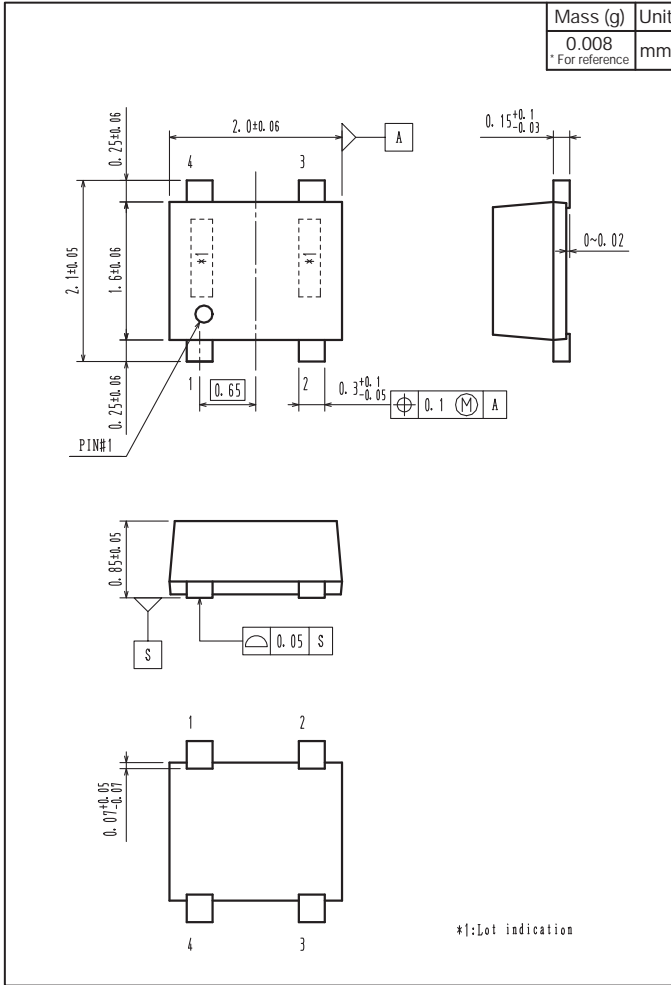

Land Pattern Example

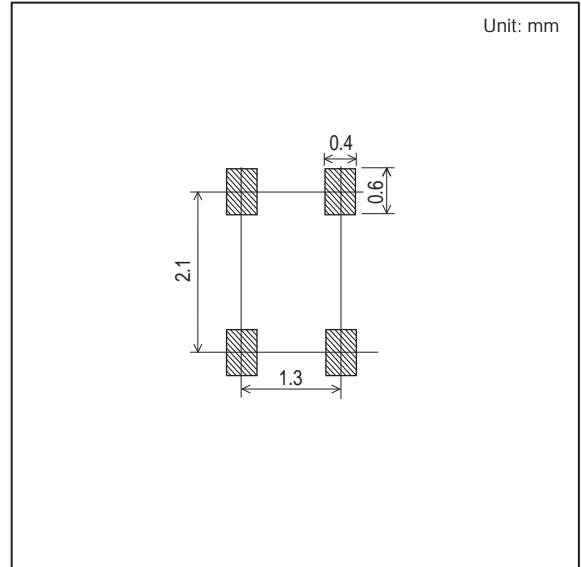

- Any and all SANYO Semiconductor Co.,Ltd. products described or contained herein are, with regard to "standard application", intended for the use as general electronics equipment. The products mentioned herein shall not be intended for use for any "special application" (medical equipment whose purpose is to sustain life, aerospace instrument, nuclear control device, burning appliances, transportation machine, traffic signal system, safety equipment etc.) that shall require extremely high level of reliability and can directly threaten human lives in case of failure or malfunction of the product or may cause harm to human bodies, nor shall they grant any guarantee thereof. If you should intend to use our products for new introduction or other application different from current conditions on the usage of automotive device, communication device, office equipment, industrial equipment etc. , please consult with us about usage condition (temperature, operation time etc.) prior to the intended use. If there is no consultation or inquiry before the intended use, our customer shall be solely responsible for the use.
- Specifications of any and all SANYO Semiconductor Co.,Ltd. products described or contained herein stipulate the performance, characteristics, and functions of the described products in the independent state, and are not guarantees of the performance, characteristics, and functions of the described products as mounted in the customer's products or equipment. To verify symptoms and states that cannot be evaluated in an independent device, the customer should always evaluate and test devices mounted in the customer's products or equipment.
- SANYO Semiconductor Co.,Ltd. assumes no responsibility for equipment failures that result from using products at values that exceed, even momentarily, rated values (such as maximum ratings, operating condition ranges, or other parameters) listed in products specifications of any and all SANYO Semiconductor Co.,Ltd. products described or contained herein.
- Regarding monolithic semiconductors, if you should intend to use this IC continuously under high temperature, high current, high voltage, or drastic temperature change, even if it is used within the range of absolute maximum ratings or operating conditions, there is a possibility of decrease reliability. Please contact us for a confirmation.
- SANYO Semiconductor Co.,Ltd. strives to supply high-quality high-reliability products, however, any and all semiconductor products fail or malfunction with some probability. It is possible that these probabilistic failures or malfunction could give rise to accidents or events that could endanger human lives, trouble that could give rise to smoke or fire, or accidents that could cause damage to other property. When designing equipment, adopt safety measures so that these kinds of accidents or events cannot occur. Such measures include but are not limited to protective circuits and error prevention circuits for safe design, redundant design, and structural design.
- In the event that any or all SANYO Semiconductor Co.,Ltd. products described or contained herein are controlled under any of applicable local export control laws and regulations, such products may require the export license from the authorities concerned in accordance with the above law.
- No part of this publication may be reproduced or transmitted in any form or by any means, electronic or mechanical, including photocopying and recording, or any information storage or retrieval system, or otherwise, without the prior written consent of SANYO Semiconductor Co.,Ltd.
- Any and all information described or contained herein are subject to change without notice due to product/technology improvement, etc. When designing equipment, refer to the "Delivery Specification" for the SANYO Semiconductor Co.,Ltd. product that you intend to use.
- Upon using the technical information or products described herein, neither warranty nor license shall be granted with regard to intellectual property rights or any other rights of SANYO Semiconductor Co.,Ltd. or any third party. SANYO Semiconductor Co.,Ltd. shall not be liable for any claim or suits with regard to a third party's intellectual property rights which has resulted from the use of the technical information and products mentioned above.

This catalog provides information as of July, 2012. Specifications and information herein are subject to change without notice.