



Agilent 81150A Pulse Function Arbitrary Noise Generator

Data Sheet, Version 1.1

81150A Pulse Function Arbitrary Noise



A high precision pulse generator enhanced with versatile signal generation, modulation and distortion capabilities for:

- Accurate signals to test your device and not your signal source
- Versatile waveform and noise generation to be ready for today's and tomorrow's stress test challenges
- Optional pattern generator to test in addition to analog, digital and mixed signal devices
- Integrated into one instrument to minimize cabling, space and test time



When signal fidelity matters – test with confidence.

Accurate and accelerated insight into your device through ideal and real-world signals.



Agilent Technologies

The 81150A Pulse Function Arbitrary Noise Generator at a Glance

- 1 μ Hz – 120 MHz pulse generation with variable rise/fall time
- 1 μ Hz – 240 MHz sine waveform output
- 14-bit, 2 GSa/s arbitrary waveforms
- 512k samples deep arbitrary waveform memory per channel
- Pulse, sine, square, ramp, noise and arbitrary waveforms
- Noise, with an adjustable crest factor, and signal repetition time of 26 days
- FM, AM, PM, PWM, FSK modulation capabilities
- 1 or 2 channel, coupled and uncoupled
- Differential outputs
- Two selectable output amplifiers:
 - High bandwidth amplifier
Amplitude: 50 mVpp to 5 Vpp; 50 Ω into 50 Ω
100 mVpp to 10 Vpp; 50 Ω into open

Voltage window: \pm 5 V; 50 Ω into 50 Ω
 \pm 10 V; 50 Ω into open
 \pm 9 V; 5 Ω into 50 Ω
 - High voltage amplifier
Amplitude: 100 mVpp to 10 Vpp; 50 Ω into 50 Ω , 200 m pp to 20 Vpp;
5 Ω into 50 Ω , or 50 Ω into open

Voltage window: \pm 10 V; 50 Ω into 50 Ω
 \pm 20 V; 5 Ω into 50 Ω or 50 Ω into open
- Glitch free change of timing, parameters (delay, frequency, transition time, width, duty cycle)
- Programming language compatible with Agilent 81101A, 81104A, 81105A
- ISO 17025 and Z540 calibration
- LXI class C compliant
- Optional pattern generator:
 - Ideal and arbitrary bit shaped pattern up to 120 Mbit/s
 - Three level signals
 - PRBS up to 2^{31}
 - 16 Mbit Pattern Memory
 - Pass through pattern for combined and physical and protocol test up to 10 Mbit/s

Front Panel

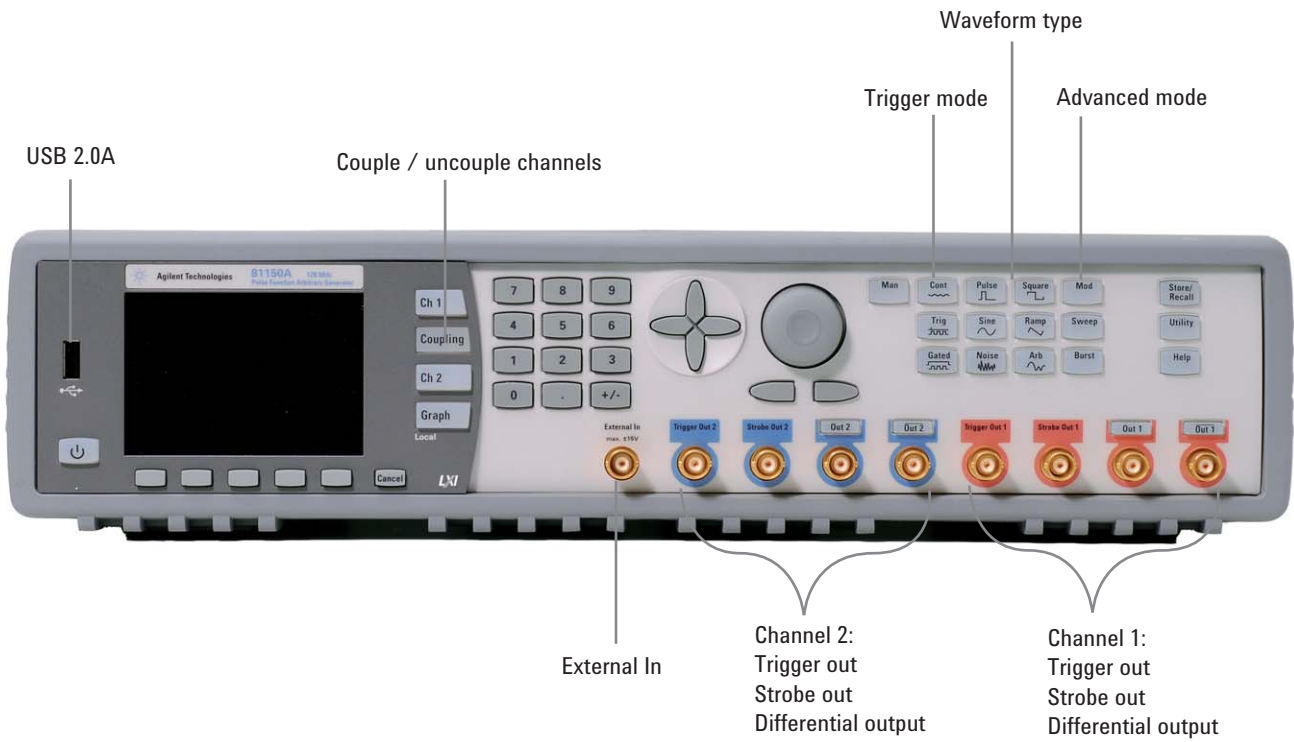

Back Panel

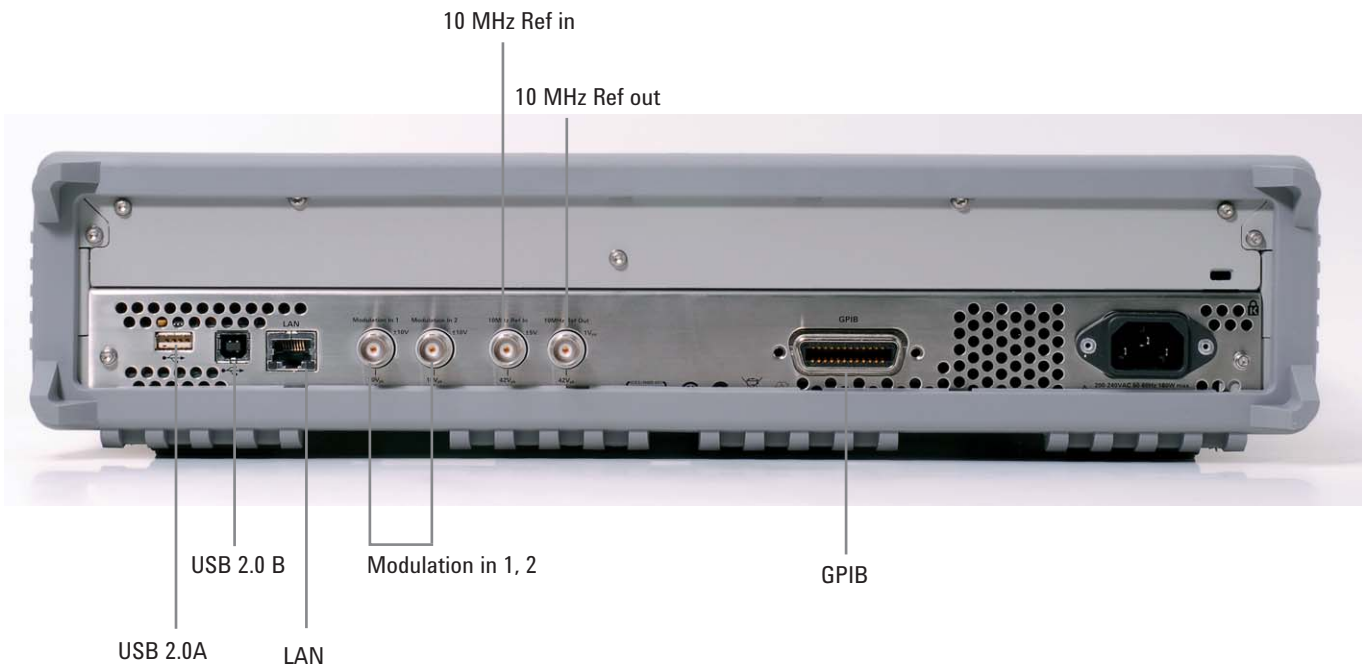

Today's Challenges Require a New Generation of Test Instruments

You are under pressure to get products to market faster and faster, with shrinking design schedules and increasing quality goals. The pressure is never ending. Because differentiation means survival in the marketplace, you often have to test unique functionality. Being confident in your results takes highly adaptable and efficient testing.

Such challenges require a new generation of test instruments, which are:

- Accurate, to test your device and not your source
- Versatile, to be ready for today's and tomorrow's test challenges
- Plug and play solutions, with minimal cabling, low space overhead and have many functions built-in

Whichever way you look at it, this starts with accurate, versatile and uncompromising signal sources.

Just test — with the signal you need.
Quad versatility - Optimum signal fidelity

Agilent's offering

The Agilent 81150A pulse function arbitrary noise generator sets the standard for the next generation of lab: for fast, accurate insight into your design or device under test.

- A pulse generator with precise signals for performance verification and characterization
- A function arbitrary generator
 - For versatile signal generation to optimize testing
 - For modulation to shape the signal the DUT needs
- A noise generator to distort signals to build up worst case scenarios
- An optional Pattern Generator to test in addition to analog, digital and mixed signal devices with ideal and real-world conditions

The new Agilent 81150A pulse function arbitrary noise generator is an indispensable contributor to accelerate ideal and real-world testing.



Figure 1. Agilent 81150A pulse function arbitrary noise generator

Pulse Generator – Test Your Device and Not Your Source

Superior precision pulses with unbeatable timing stability guarantee reproducible tests. The signal quality and trigger functionality provide everything you need for trigger or system clock applications.

You can change the timing parameters (delay, frequency, transition time, width, duty cycle) without dropouts or glitches. This patented, industry-leading feature means continuous operation without having to reboot or reset your device under test, for example when you are characterizing a device by sweeping the clock frequency. Apart from full control of the timing parameters, you can also adjust levels and edges as needed.

81150A channel 1 pulse setup

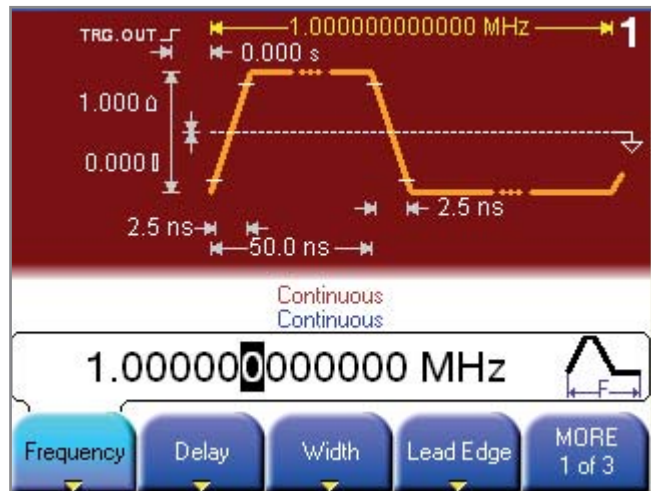

Set up complex measurements

The Agilent 81150A pulse function arbitrary noise generator is available in a 1 or 2 channel version. On the two channel version, the channels can be uncoupled, to work independently, or coupled, for example, with a defined delay between them.

Each channel provides trigger out, strobe out and differential outputs: the basis for many complex test set ups.

Measurement using strobe and trigger

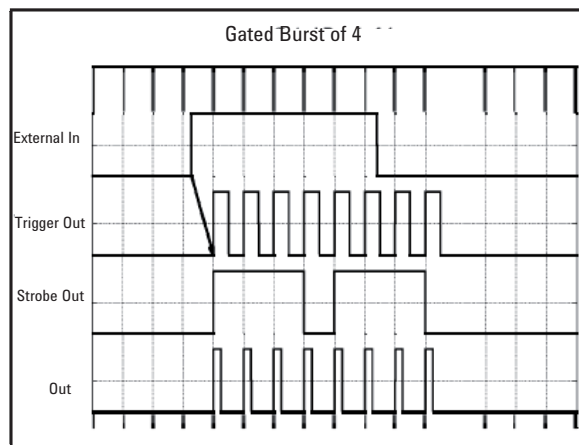

Function Arbitrary Generator – Stress Your Device to its Limit

If you need further signal conditioning, the Agilent 81150A pulse function arbitrary noise generator provides versatile waveforms and modulation capabilities to adapt your signal to your device's requirements. AM, FM, FSK, PM and PWM are available at modulation frequencies up to 10 MHz.

The Agilent 81150A pulse function arbitrary noise generator can use internal or external modulation sources. Internal modulation can be generated from the 2nd channel or the internal modulation source of the modulated channel.

Amplitude modulation

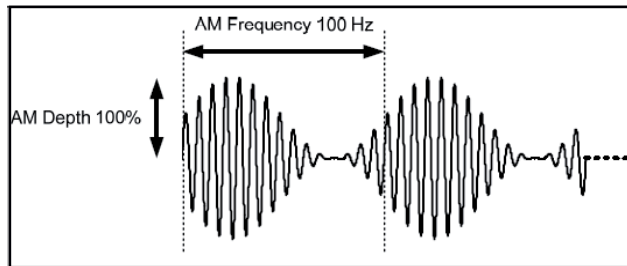

Frequency shift key modulation

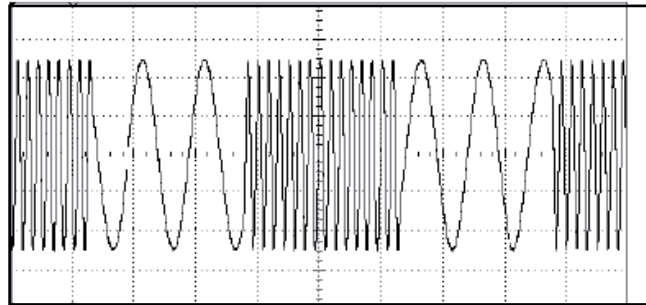

Pulse width modulation

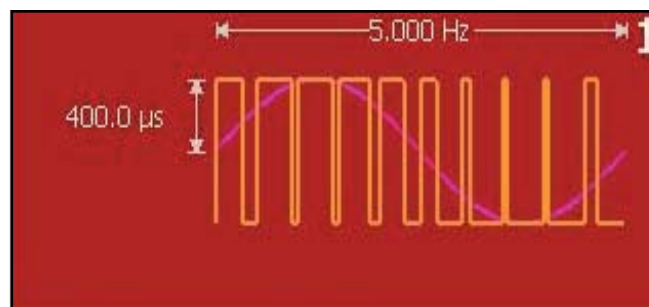

Frequency sweep

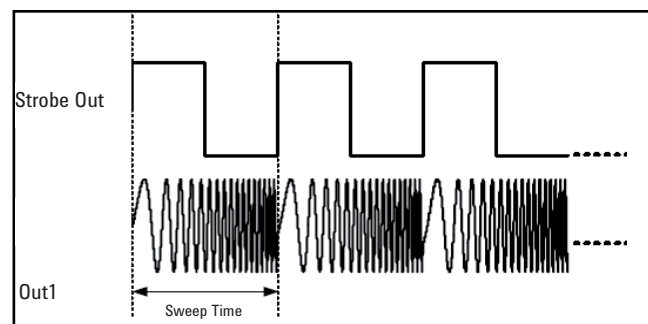

Setting up a measurement using trigger, strobe, modulation and carrier

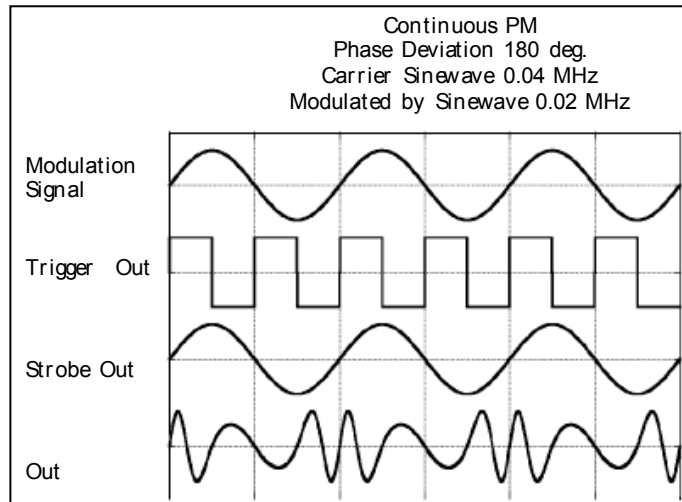

Noise generator – repeatable and stochastic noise

Jitter and noise cause misalignment of edges and levels, resulting in data errors. Noise is by its nature unpredictable because it can have many different causes, from signal interference caused by sudden voltage changes, to distortions introduced during transmission.

It is important to be able to simulate noise-based malfunctions, for example, to identify the additive noise produced by receiving systems – it is cheaper to lower the noise figure than to increase the transmitter power! The Agilent 81150A pulse function arbitrary noise generator lets you control the quality of the noise, to test different cases, and according to various specifications.

Gaussian white noise is a good approximation to many real-world situations, and creates mathematically traceable models, with statistical independent values. The Agilent 81150A pulse function arbitrary noise generator provides deterministic Gaussian white noise, with a signal repetition of 26 days. You can decide on any arbitrary distribution, and trigger the noise to start when you need it.

Gaussian curve and distribution

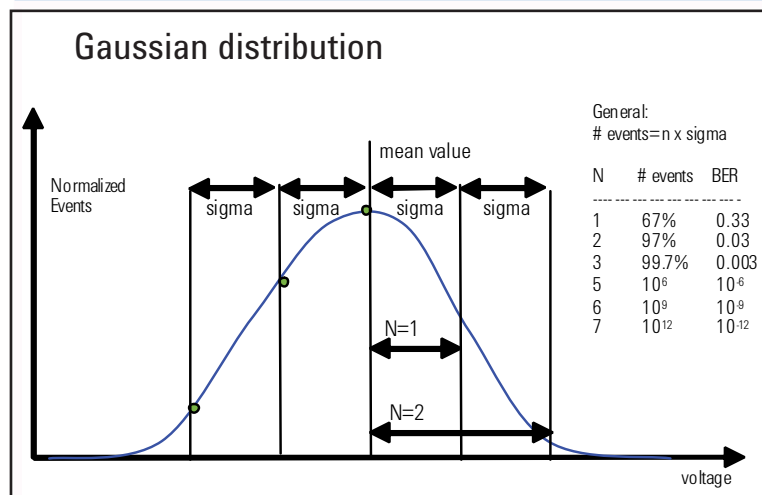

Voltage level crest factor

You can also select the crest factor out of 4 values – an indicator of signal quality – using V_p/V_{RMS} or V_{pp}/V_{RMS} scales, depending on the standard to which you are testing.

The 81150A uses the definition: crest factor = V_p/V_{RMS}

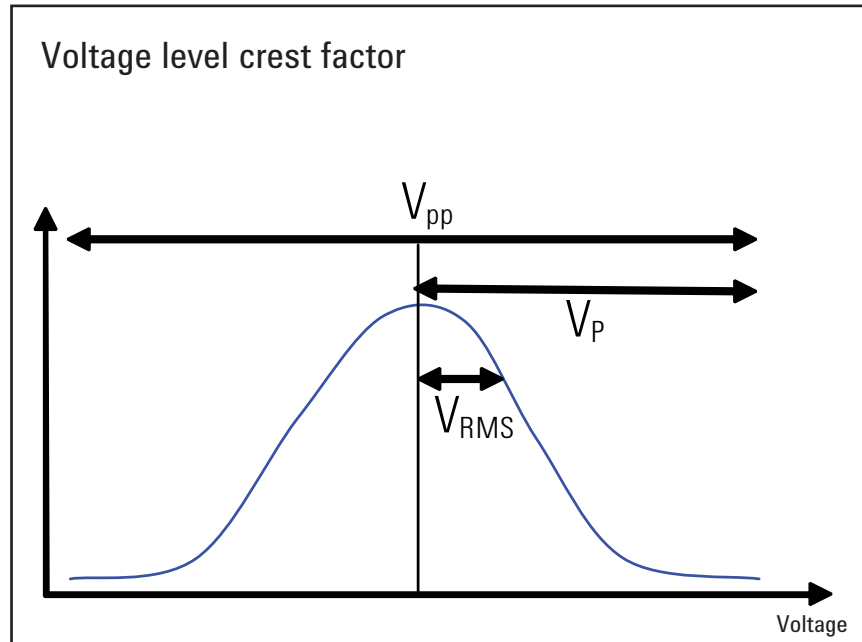

The result is noise that combines two extremes:

- Random and repeatable noise, for stress tests on one side
- While still being sufficiently random

Pattern Generator - Test in addition to analog, digital and mixed signal devices

Software upgrade to 81150A

Engineers working with serial buses or designers of analog, digital and mixed signal devices require stressing their design with pattern. The Agilent 81150A arbitrary bit shaped pattern generator allows sending ideal and real-world pattern. The Agilent 81150A with arbitrary bit shaped pattern allows emulating overshoot, asymmetric delay and duty cycle distortion up to 120 Mbit/s. Patterns can be easily set up and distorted at your fingertips.

Stress your device to it's limits—Define your own bit shape

Arbitrary bit shaped pattern

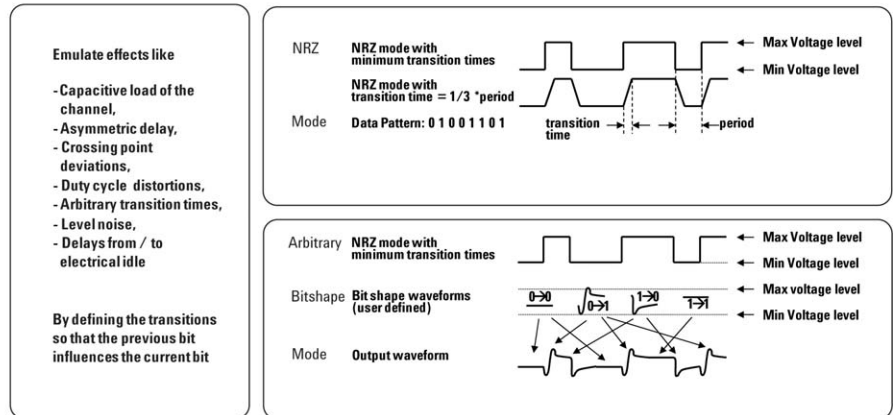

The 81150A Pattern Generator lets you define the transitions from bit to the other so that the previous bit influences the current bit. The user can set up own defined arbitrary bit shapes.

PRBS

In addition to user-defined pattern standard pattern like PRBS up to 2³¹ are available.

Sequencer

The Sequencer allows setting up a pre-ambule sequence so that the Device under Test moves into test mode. With the 3-Level signals it is no longer necessary to add different signals for electrical idle. Up to 4 levels are available in the expert mode.

3-Level Signals

Bit and Block Trigger Mode

Besides standard trigger modes like continuous bit and block trigger modes allow adoptions to application needs. In the bit mode you see that on every trigger, the sequence is advanced by one bit. An application example is a bit clock, which can be fed into an external clock then into the trigger input.

In the block mode the entire data block is generated once per trigger event. This is interesting for example in applications with protocol data.

Pass through pattern for combined physical and protocol test up to 10 Mbit/s

The 81150A pattern generator passes the data through to the Device under Test and adopts it to any kind of stress test (shape and timing change).

Bridge the gap between Protocol and Physical Layer Test – in real time up to 10 Mbit/s

Increase your test efficiency by combining physical layer test with protocol test

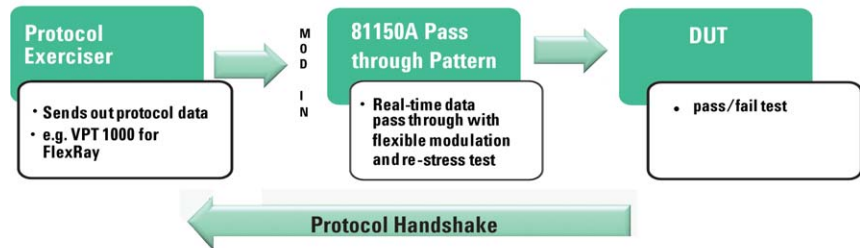

The 81150A pass-through pattern functionality takes the protocol data via “mod in” and adopts it to any kind of stress test (shape and timing changes)

Modulation

Modulation of the pattern signal enables you to emulate real-world conditions.

AM – amplitude of the pattern signal is multiplied by the modulation signal to emulate level distortions of the data signal e.g. Sinusoidal interference.

FM – frequency of the pattern signal is modulated to emulate SSC on the data signal.

PM – the phase of the data bits is modulated to emulate jitter on the data signal.

Connectivity

Filling the arbitrary memory easily

There are several possibilities for filling the arbitrary memory. There are 6 built-in, standard arbitrary waveforms, but you can also create any waveform you need, either on the instrument or on a PC, using the 81150A IntuiLink waveform editor.

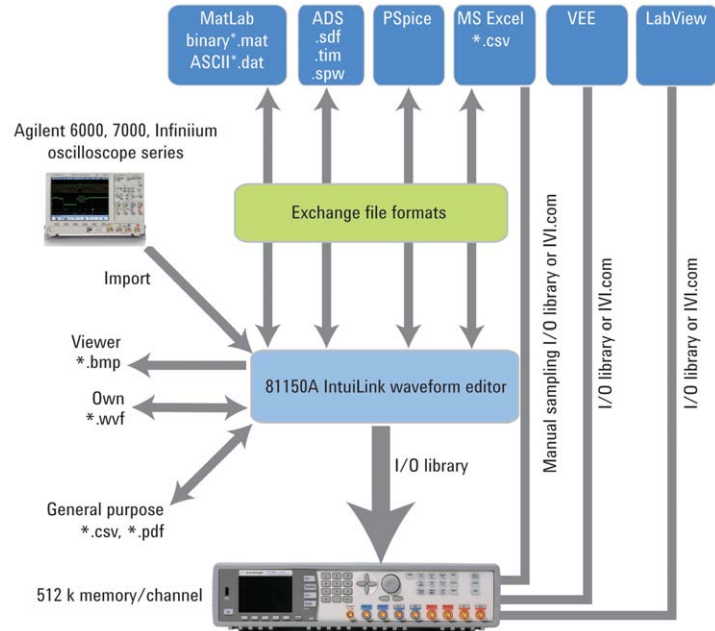

Measurement – anywhere and anytime

The Web interface allows you to use the full functionality and feature set of the Agilent 81150A pulse function arbitrary noise generator from any Web interface.

Channel 1: instrument view

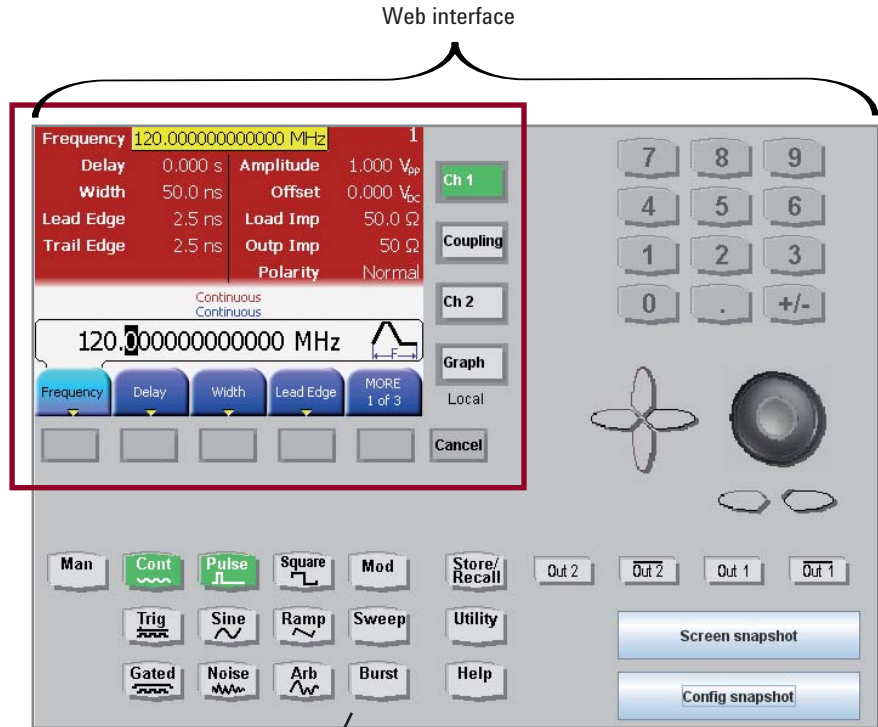

Just decide on the waveform

Channel 2

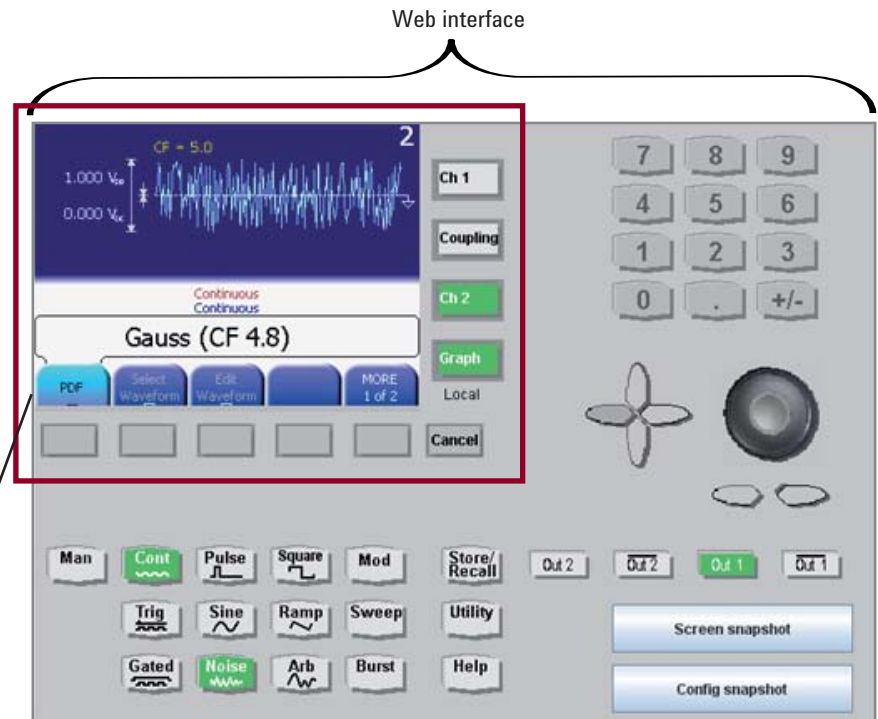

Choose the crest factor / probability function you need

Modes of Operation

There are four components to the mode of operation:

- Coupling between channels
- Trigger mode
- Waveform type
- Advanced modes

Coupling between channel 1 and 2

The two channel version has two distinct modes of operation:

- **Coupling off:** The two channels operate independently. Frequency generation for both channels is based on the same clock reference, but can be selected independently.
- **Coupling on:** The frequency, trigger mode, waveform type and advanced mode are identical for both channels. The fix delay of channel 1 and channel 2 is the same.

Trigger modes

- **Continuous:** Continuous waveform, burst, sweep or modulation. The External In is not used in continuous mode.
- **Externally triggered:** Each active transition at the External In (rising, falling or both) generates a single waveform, burst or sweep.
- **Externally gated:** The active level (high or low) at the External In enables waveforms, bursts or sweeps. The last waveform, burst or sweep is always completed.
- **Internally triggered:** The internal clock replaces the external trigger source. This can be applied for waveform, burst, or sweep.
- **Manual:** This generates a single trigger. The source is either a button on the front panel or a remote command.

Trigger rate: 1 μ Hz to 120 MHz (external or internal)

Waveform types

- Standard waveforms: pulse, sine, square, ramp, noise, arbitrary
- Predefined arbitrary waveforms: exponential rise, exponential fall, $\sin(x)/x$, cardiac and DC

Pulse characteristics

Pulse characteristics	
Frequency range	
High bandwidth amplifier	1 μ Hz to 120 MHz
High voltage amplifier	1 μ Hz to 50 MHz
Pulse width	
Range	
High bandwidth amplifier	4.16 ns to (period - 4.16 ns)
High voltage amplifier	10 ns to (period - 10 ns)
Resolution	100 ps, 6 digits
Accuracy	± 500 ps ± 50 ppm
Transition time (independent rise and fall)	
Range	
High bandwidth amplifier	2.5 ns to 1000 s (10% to 90%)
High voltage amplifier	7.5 ns to 1000 s (10% to 90%)
Resolution	100 ps, 6 digits
Accuracy	
High bandwidth amplifier	± 500 ps ± 50 ppm
High voltage amplifier	-1000 ps to +500 ps ± 50 ppm
Overshoot	2% typ.

Sine characteristics

Sine characteristics	
Frequency range	
High bandwidth amplifier	1 μ Hz to 240 MHz
High voltage amplifier	1 μ Hz to 50 MHz
Harmonic distortion	1 Vpp 3 Vpp
(High bandwidth amplifier 50 Ω into 50 Ω)	
1 μ Hz to 2 MHz	< -65 dBc < -62 dBc
2 MHz to 10 MHz	< -62 dBc < -55 dBc
10 MHz to 35 MHz	< -50 dBc < -45 dBc
35 MHz to 70 MHz	< -35 dBc < -30 dBc
70 MHz to 240 MHz	< -22 dBc < -17 dBc
Harmonic distortion	10 Vpp
(High voltage amplifier 50 Ω into 50 Ω)	
1 μ Hz to 1 MHz	< -55 dBc
1 MHz to 10 MHz	< -40 dBc
10 MHz to 50 MHz	< -27 dBc
Non-harmonic (spurious) distortion	
1 μ Hz to 20 MHz	-60 dBc typ.
20 MHz to 200 MHz	-55 dBc typ.
200 MHz to 240 MHz	-50 dBc typ.
SSB phase noise (10 kHz offset)	
1 MHz	-119 dBc/Hz typ.
10 MHz	-115 dBc/Hz typ.
240 MHz	-93 dBc/Hz typ.

Square characteristics

Square characteristics	
Frequency range	
High bandwidth amplifier	1 μ Hz to 120 MHz
High voltage amplifier	1 μ Hz to 50 MHz
Duty cycle	
High bandwidth amplifier	(Freq/240 MHz) to 1 - (Freq/240 MHz) e.g. 60 MHz 25% to 75%
High voltage amplifier	(Freq/100 MHz) to 1 - (Freq/100 MHz) e.g. 1 MHz 1% to 99%
Resolution	0.1%
Transition time (10% to 90%)	
High bandwidth amplifier	2.5 ns typ. fixed
High voltage amplifier	6 ns typ. fixed
Overshoot	2% typ.

Ramp characteristics

Ramp characteristics	
Frequency range	1 μ Hz to 5 MHz
Linearity	< 0.1% (f < 10 kHz)
Symmetry	0.0% to 100%

Noise characteristics

Noise characteristics	
Bandwidth	
High bandwidth amplifier	120 MHz typ.
High voltage amplifier	40 MHz typ.
Amplitude distribution	Selectable Gaussian, user defined
Crest factor (peak/RMS) selectable	3.1, 4.8, 6.0, 7.0 typ. (Gaussian distribution)
Noise type	Deterministic, triggerable
Repetition time	~26 days

Arbitrary characteristics

Arbitrary characteristics	
Waveform length	2 points to 512k points
Sample rate	
Memory	1 GSa/s
DAC	2 GSa/s ⁽¹⁾
Amplitude resolution	14 bits
Frequency range	1 μ Hz to 120 MHz
Transition time	
High bandwidth amplifier	1.7 ns typ.
High voltage amplifier	5 ns typ.
Filter bandwidth	
High bandwidth amplifier	240 MHz typ.
High voltage amplifier	80 MHz typ.
PP jitter	1 ns typ.

1. Linear interpolation between two memory samples

Advanced Modes

Three advanced modes exist:

- Modulation: selects the modulation type: AM, FM, PM, FSK, PWM
- Sweep: for frequency sweeps.
- Bursts: repeats selected waveform n times.

Modulation

A modulation input (for AM, FM, PM, FSK, PWM) for each channel is provided on the back-panel. In the two channel instrument one channel can also modulate the other channel.

Modulation In1 / modulation In2	
Input range (full scale)	Selectable ± 2.5 V or ± 5 V
Frequency range	DC to 10 MHz
Input impedance	Selectable 10 k Ω , 50 Ω nominal
Connector	BNC, back panel

AM	
Carrier waveforms	Sine, square, ramp, arbitrary
Internal modulation	Sine, square, ramp (up, 50%, down), noise, arbitrary
Modulation frequency	
Internal	1 MHz to 10 MHz
External	DC to 10 MHz
Depth	0% to 120%
Double-sideband suppressed carrier	Selectable on/off
Source	Internal, external, channel

FM	
Carrier waveforms	Sine, square, ramp, arbitrary
Internal modulation	Sine, square, ramp (up, 50%, down), noise, arbitrary
Modulation frequency	
Internal	1 MHz to 10 MHz
External	DC to 10 MHz
Deviation range	1 μ Hz to 240 MHz ⁽¹⁾
Source	Internal, external, channel

1. Max frequency depends on selected waveform

PM	
Carrier waveforms	Sine, square, ramp, arbitrary
Internal modulation	Sine, square, ramp (up, 50%, down), noise, arbitrary
Modulation frequency	
Internal	1 MHz to 10 MHz
External	DC to 10 MHz
Deviation range	0.0° to 360.0°
Source	Internal, external, channel

FSK

FSK	
Carrier waveforms	Sine, square, ramp, arbitrary
Internal modulation	50% square
FSK rate	1 mHz to 10 MHz
Frequency range	1 mHz to 240 MHz ⁽¹⁾ ⁽²⁾
Source	Internal, external, channel

1. Max frequency depends on selected waveform

2. For export control: Effective switching time is 40 ns

PWM

PWM	
Carrier waveform	Pulse
Internal modulation	Sine, square, ramp (up, 50%, down), noise, arbitrary
Modulation frequency	
Internal	1 mHz to 10 MHz
External	DC to 10 MHz
Deviation range	0% to 100% of pulse width
Source	Internal, external, channel

Sweep

An independent frequency sweep is provided for each channel.

Sweep	
Waveforms	Pulse, sine, square, ramp, triangle, arbitrary
Type	Linear or logarithmic
Direction	Up or down
Sweep time	100 μ Hz to 500 s
Start frequency / stop frequency	1 μ Hz to 240 MHz ⁽¹⁾
Trigger source	External, internal, manual
Marker	Frequency marker

1. Max frequency depends on selected waveform

Burst

An independent burst capability is provided for each channel.

Burst	
Waveforms	Pulse, sine, square, ramp, triangle, arbitrary
Frequency	1 μ Hz to 120 MHz
Modes	Externally triggered, internally triggered, externally gated
# of waveforms in a burst	2 to 1,000,000
Trigger period	16.7 ns to 9999 s
Start phase ⁽¹⁾	-360° to +360°
Gate source	External
Trigger source	External, internal, manual

1. Available for all waveforms except pulse, square and ramp

Outputs

Main outputs

A selectable single-ended or differential output is provided for each channel on the front-panel.

Max. frequency	
High bandwidth amplifier	120 MHz pulse / 240 MHz sine
High voltage amplifier	50 MHz

Out1/Out2	
Output type	Single-ended or differential
Amplitude (50 Ω into 50 Ω)	
High bandwidth amplifier	
1 μ Hz to 120 MHz	50 mVpp to 5 Vpp ⁽¹⁾
120 MHz to 240 MHz	50 mVpp to 3Vpp ⁽¹⁾
High voltage amplifier	
1 μ Hz to 50 MHz	100 mVpp to 10 Vpp ⁽¹⁾
Amplitude (50 Ω into open, 5 Ω into 50 Ω)	
High bandwidth amplifier	
1 μ Hz to 120 MHz	100 mVpp to 10 Vpp ⁽¹⁾ (to 9 Vpp ⁽²⁾)
120 MHz to 240 MHz	100 mVpp to 5 Vpp ⁽¹⁾
High voltage amplifier	
1 μ Hz to 50 MHz	200 mVpp to 20 Vpp ⁽¹⁾
DC amplitude accuracy	\pm (1.5% of setting + 5 mV)
Voltage window (50 Ω into 50 Ω)	
High bandwidth amplifier	-5 V to +5 V
High voltage amplifier	-10 V to +10 V
Voltage window (50 Ω into open, 5 Ω into 50 Ω)	
High bandwidth amplifier	-10 V to +10 V ⁽¹⁾ (-9 V to +9 V ⁽²⁾)
High voltage amplifier	-20 V to +20 V
DC offset accuracy	
\pm 5 V Voltage window	\pm (25 mV + 1%)
\pm 10 V Voltage window	\pm (50 mV + 1%)
\pm 20 V Voltage window	\pm (75 mV + 1%)
Resolution	1 mV, 4 digits
Output impedance	Selectable 50 Ω / 5 Ω typ.
Variable load impedance	0.3 Ω to 1 M Ω ⁽³⁾
Protection	Short-circuit protected, overload disables main output
Connector	BNC, front panel

1. All amplitudes are single-ended amplitudes. Differential peak-peak amplitudes are twice the single-ended value.

2. 10 Vpp for 50 Ω into open; 9 Vpp for 5 Ω into 50 Ω

3. Current of normal out plus current of complement out is limited to 440 mA per channel

Clock Reference

External reference output	
Frequency	10 MHz
Accuracy	± 50 ppm
Stability	± 2 ppm, 0° to 50°C
Aging	± 1 ppm per year
Output level	1 V nominal
Impedance	$50\ \Omega$ nominal, AC coupled
Connector	BNC, rear panel

External reference input	
Lock range	$10\ \text{MHz} \pm 500\ \text{ppm}$
Input range	$200\ \text{mV}_{\text{pp}}$ to $5\ \text{V}_{\text{pp}}$
Impedance	$1\ \text{k}\Omega$ nominal, AC coupled
Connector	BNC, rear panel

Internal frequency characteristics

Internal frequency characteristics	
Accuracy	± 50 ppm
Stability	± 2 ppm, 0° to 50°C
Aging	± 1 ppm per year

External Input

A common external input is provided for both channels on the front panel. The external In is used for external trigger or external gate modes.

External input	
Frequency range	DC to 120 MHz
Input range	-10 V to +10 V
Maximum input amplitude	10 V _{pp}
Input sensitivity	200 mV _{pp}
Threshold	
Range	-10 V to 10 V
Resolution	100 mV
Impedance	Selectable 10 k Ω /50 Ω , DC coupled
Slope	Selectable, rising/falling/both
Pulse width	> 3.3 ns
Transition time	< 100 ns
Connector	BNC, front panel

Trigger Outputs

A separate trigger output is provided for each channel on the front-panel.

In advanced mode internally/externally modulated (AM, FM, PM, PWM), the trigger output has the frequency of the unmodulated carrier waveform, with a 50% duty cycle.

For FSK modulation the trigger output outputs the same frequency as the data output. That is, it alternates between the two frequencies.

If noise is selected, a trigger signal is generated when noise is restarted internally, externally or manually.

Trigger Out1/Trigger Out2	
Output level	Selectable TTL/ECL
TTL	0 V / 2.5 V nominal
ECL	-0.85 V / -1.80 V nominal
Pulse width	
Internally triggered, continuous	50% duty cycle typ.
Externally triggered	4 ns typ.
Transition time (20% to 80%)	2.0 ns typ.
Maximum rate	120 MHz ⁽¹⁾
Impedance	50 Ω nominal
Connector	BNC, front panel

1. For output frequencies > 120 MHz, the trigger rate is $\frac{1}{4}$ of the output frequency. If a frequency sweep or a FSK frequency exceeds 120 MHz, the trigger rate is $\frac{1}{4}$ of the output frequency.

Strobe Outputs

A strobe output is provided for each channel on the front-panel.

The strobe output signal has a different function, depending on the mode of operation.

If no advanced mode is selected, the strobe output is a constant low.

In advanced mode internal/external triggered or gated burst, the strobe output provides a signal indicating the duration of a burst. The rising edge of the strobe signal is synchronized to the start of the first waveform period in a burst. The falling edge is synchronized to the start of the last waveform period in the burst.

In advanced mode sweep with the frequency marker off, the strobe output is a pulse with half the duration of the sweep. The strobe signal goes high at the beginning of the sweep.

In advanced mode sweep with the frequency marker on, the strobe output goes high at the beginning of the sweep and goes low at the marker frequency.

In advanced mode internally / externally modulated (AM, FM, FSK, PM, PWM), the strobe output is the analog modulation waveform.

Strobe Out1/Strobe Out2	
Digital output level	Selectable TTL/ECL
TTL	0 V / 2.5 V nominal
ECL	-0.85 V / -1.80 V nominal
Analog output level (modulator)	-2 V to 2.0 V (full scale)
Impedance	50 Ω nominal
Connector	BNC, front panel
Min pulse width	4 ns typ.
Transition time (20% to 80%)	2.0 ns typ.

Digital Channel Addition

If the instrument is equipped with two output channels, channel 2 can be added to channel 1 internally. The maximum output voltage of channel 1 remains unchanged. If channel addition is selected, channel 2 outputs the unchanged waveform of channel 1.

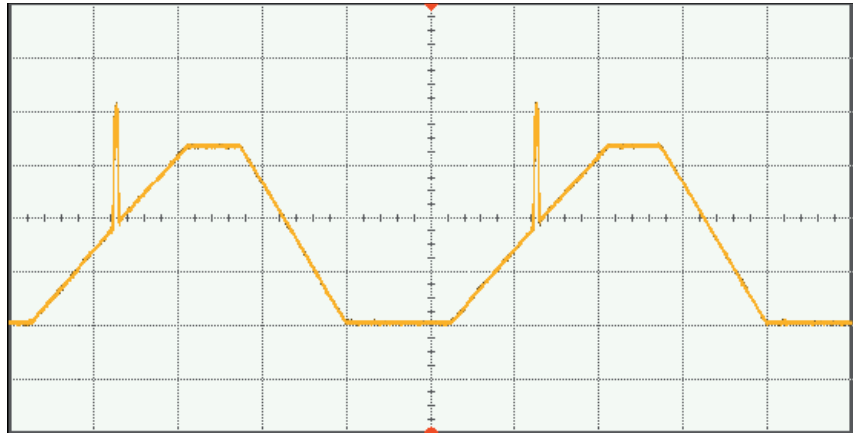

Timing characteristics

External in timing characteristics

Delay: external in to main out 1, 2

Fix delay	
Advance mode: off, burst	366 ns typ, fixed
Advanced mode: sweep	350 ns typ, fixed

Variable delay ⁽¹⁾	Independent for out 1, out 2
Range	0 s to 1000 s ⁽²⁾
Resolution	100 ps, 6 digits
Accuracy	± 25 ps ± 50 ppm

Delay: external in to trigger out 1, 2

Fix delay	
Advanced mode: sweep	350 ns typ, fixed

Delay: external in to trigger out 1, 2

Fix delay	
Advanced mode: off, burst	366 ns typ, fixed
Pattern mode:	data 406 ns typ.
Advanced mode: sweep	350 ns typ, fixed

Jitter⁽³⁾

External in to main out 1, 2	70 ps peak-peak typ.
External in to trigger out 1, 2	70 ps peak-peak typ.
External in to strobe out 1, 2	70 ps peak-peak typ.

1. Not available, if sweep or modulation is selected

2. Trigger period ≥ variable delay

3. External in amplitude > 500 mV. External in transition time < 10 ns. Valid for external triggered pulse, square, sine, ramp, arb. external triggered noise or external triggered sweep has peak-peak jitter of 8 ns typ.

Continuous or internally triggered timing characteristics

Continuous or internally triggered timing characteristics	
Delay: trigger out 1, 2 to main out 1, 2	
Fix delay:	0 ns typ, fixed
Variable delay out 1, 2 ⁽¹⁾	Independent for out 1, out 2
Range in continuous mode ⁽²⁾	0 to 1 waveform period
Range in internally triggered ⁽³⁾	0 to 1000 s
Resolution	100 ps, 6 digits
Accuracy	± 25 ps ± 50 ppm
Delay: trigger out 1, 2 to strobe out 1, 2	
Advanced mode: burst	0 ns typ, fixed
Jitter ⁽⁴⁾	
Main out 1, 2 to main out 1, 2	35 ps peak-peak typ.
Trigger out 1, 2 to main out 1, 2	40 ps peak-peak typ.
Trigger out 1, 2 to strobe out 1, 2	45 ps peak-peak typ.
Trigger out 1, 2 to trigger out 1, 2	45 ps peak-peak typ.

1. Not available, if sweep or modulation is selected
2. Advanced mode = off or advanced mode = burst
3. Trigger period ≥ variable delay
4. Valid for continuous or internal triggered pulse, square, sine, ramp, arb. Internally triggered or continuous noise or sweep has peak-peak jitter of 8 ns typ.

Coupled mode on timing characteristics

Coupled mode on timing characteristics	
Delay: main out 1 to main out 2	
Fix delay	0 ns typ.
Variable delay out 1, 2 ⁽¹⁾	Independent for out 1, out 2
Range in continuous mode ⁽²⁾	0 to 1 waveform period
Range in internally triggered ⁽³⁾	0 to 1000 s
Resolution	100 ps, 6 digits
Accuracy	± 25 ps ± 50 ppm

1. Not available, if sweep or modulation is selected
2. Advanced mode = off or advanced mode = burst
3. Trigger period ≥ variable delay

Pattern Generator (optional)

Pattern Generator (optional)	
Data rate	Up to 120 Mbit/s (with internal pattern source)
Pattern memory	16 Mbit with 1 Bit resolution
Number of levels	2, 3, or 4 (user selectable)
Sequencing	Preamble followed by one looped data block loop count: 1 - 10,000,000 the whole sequence can looped infinitely or triggered
Trigger modes	continuous, gated, bit at a time, sequence at a time
Pattern sources	- PRBS -7, 9, 11, 15, 23, and 31 - User-defined - real-time pass-through pattern via MOD-IN connector up to 10 Mbit/s
External Sampling	Automatic and fixed
Pattern modulation	AM, FM, PM
Arbitrary Bit Shapes	User defined and predefined bit transitions with up to 64 arbitrary waveform points per bit transitions

Download Times

Block transfer is the fastest way to download waveforms to the Agilent 81150A pulse function arbitrary noise generator. This is the type of download the 81150A IntuiLink Waveform Editor and the 81150A IVI-COM driver use.

Download times: block transfer			
	USB 2.0	GPIB	LAN
1 k points	31 ms typ.	35 ms typ.	35 ms typ.
8 k points	65 ms typ.	120 ms typ.	80 ms typ.
64 k points	700 ms typ.	1 s typ.	730 ms typ.
512 k points	2.9 s typ.	5.2 s typ.	3.7 s typ.

Download times: integer comma separated values			
	USB 2.0	GPIB	LAN
1 k points	220 ms typ.	200 ms typ.	220 ms typ.
8 k points	1.8 s typ.	1.6 s typ.	1.4 s typ.
64 k points	14.2 s typ.	12.6 typ.	12 s typ.

Download times: float comma separated values			
	USB 2.0	GPIB	LAN
1 k points	290 ms typ.	280 ms typ.	270 ms typ.
8 k points	2.4 s typ.	2.1 s typ.	1.9 s typ.
64 k points	20 s typ.	16 s typ.	15 s typ.

81150A IntuiLink Waveform Editor import file formats

Import file formats	
Excel	.xls .txt .prn .csv
Matlab	.mat .dat
ADS	.sdf .tim .spw
Pspice	.txt .out
DSO7000, MSO7000 Series	
DSO6000,MSO6000 Series	
5000 Series	
Infiniium (8000, 80000, 548xx) Series	
546xx Series	

General Specifications

General specifications	
Power supply	100 V to 240 V ~, 50-60 Hz 100 V to 127 V ~, 50-400 Hz
Power consumption	180 W max.
Operating temperature	0 °C to 50 °C
Operating altitude	Up to 2000 m
Storage temp.	-40 °C to 70 °C
Stored states	4 named user configurations and factory default
Power on state	Default or last state
Interface	2 x USB 2.0 standard A, 1 x USB 2.0 standard B, GPIB and LAN 10/100
Programming language	SCPI-1997 IEEE-488.2
Dimensions (WxHxD)	
Bench top	439 mm x 108 mm x 456 mm
Rack mount	428 mm x 89 mm x 439 mm
Weight	8 kg
Safety designed to	IEC61010-1 UL61010 CSA22.2 61010.1 certified
EMC tested to	IEC61326
Warm up time	30 min.
Calibration interval	1 year recommended
Warranty	1 year standard

Cooling requirements: When operating the 81150A choose a location that provides at least 80 mm of clearance at rear, and at least 30mm of clearance at each side.

Available Modes of Operation

Continuous								
		Pulse	Square	Sine	Ramp	Noise	Arb	DC
Advanced mode: off		Y	Y	Y	Y	Y	Y	Y
Advanced mode: burst		Y	Y	Y	Y	N	Y	N
Advanced mode: Modulation	AM	N	Y	Y	Y	N	Y	N
	FM	N	Y	Y	Y	N	Y	N
	PM	N	Y	Y	Y	N	Y	N
	FSK	N	Y	Y	Y	N	Y	N
	PWM	Y	N	N	N	N	N	N
Advanced mode: sweep		N	Y	Y	Y	N	Y	N

Internally triggered or externally triggered								
		Pulse	Square	Sine	Ramp	Noise	Arb	DC
Advanced mode: off		Y	Y	Y	Y	Y	Y	N
Advanced mode: burst		Y	Y	Y	Y	N	Y	N
Advanced mode: Modulation	AM	N	N	N	N	N	N	N
	FM	N	N	N	N	N	N	N
	PM	N	N	N	N	N	N	N
	FSK	N	N	N	N	N	N	N
	PWM	N	N	N	N	N	N	N
Advanced mode: sweep		N	Y	Y	Y	N	Y	N

Gated								
		Pulse	Square	Sine	Ramp	Noise	Arb	DC
Advanced mode: off		Y	Y	Y	Y	Y	Y	N
Advanced mode: burst		Y	Y	Y	Y	N	Y	N
Advanced mode: Modulation	AM	N	N	N	N	N	N	N
	FM	N	N	N	N	N	N	N
	PM	N	N	N	N	N	N	N
	FSK	N	N	N	N	N	N	N
	PWM	N	N	N	N	N	N	N
Advanced mode: sweep		N	Y	Y	Y	N	Y	N

Ordering Information

Agilent 81150A

#001	1-channel pulse function arbitrary noise generator
#002	2-channel pulse function arbitrary noise generator
#1A7 ¹	ISO17025 calibration documents
#1A6 ¹	Z540 calibration documents
#PAT	Licence for Pattern Generator

1. Available for following specifications: Level, frequency, harmonic distortion, variable delay accuracy

Accessories included

- Certificate of calibration
- Local power cord
- USB cable
- Agilent automation ready CD (Agilent I/O Library, IVI-COM driver)
- Product CD (data sheet, user guide, getting started guide, 81150 IntuiLink Waveform Editor Software, examples for remote access)

Optional accessories

#DOC	Printed documentation. Includes printed getting started guide and printed user guide
#1CP	Rack mount kit
#R1280A	Additional 2-years warranty (3-years total)

Upgrades for 81150A

81150AU	
#PAT	License for Pattern Generator
#DOC	printed documentation

Literature title	Publication number
<i>Pulse Pattern and Data Generators Brochure</i>	5980-0489E
<i>81150A Pulse Function Arbitrary Noise Generator Demo Guide</i>	5989-7718EN
<i>81150A Pulse Function Arbitrary Noise Generator Flyer</i>	5989-7720EN
<i>81150A Pulse Function Arbitrary Noise Generator Application Booklet</i>	5989-7860EN

For the latest version of this document, please visit our website at: www.agilent.com/find/81150 and go to the Product Library.

Remove all doubt

Our repair and calibration services will get your equipment back to you, performing like new, when promised. You will get full value out of your Agilent equipment through-out its lifetime. Your equipment will be serviced by Agilent-trained technicians using the latest factory calibration procedures, automated repair diagnostics and genuine parts. You will always have the utmost confidence in your measurements. For information regarding self maintenance of this product, please contact your Agilent office.

Agilent offers a wide range of additional expert test and measurement services for your equipment, including initial start-up assistance, onsite education and training, as well as design, system integration, and project management.

For more information on repair and calibration services, go to:

www.agilent.com/find/removealldoubt



www.lxistandard.org

LXI is the LAN-based successor to GPIB, providing faster, more efficient connectivity. Agilent is a founding member of the LXI consortium.



Agilent Email Updates

www.agilent.com/find/emailupdates

Get the latest information on the products and applications you select.



Agilent Direct

www.agilent.com/find/agilentdirect

Quickly choose and use your test equipment solutions with confidence.

www.agilent.com
www.agilent.com/find/81150

For more information on Agilent Technologies' products, applications or services, please contact your local Agilent office. The complete list is available at:

www.agilent.com/find/contactus

Americas

Canada	(877) 894-4414
Latin America	305 269 7500
United States	(800) 829-4444

Asia Pacific

Australia	1 800 629 485
China	800 810 0189
Hong Kong	800 938 693
India	1 800 112 929
Japan	0120 (421) 345
Korea	080 769 0800
Malaysia	1 800 888 848
Singapore	1 800 375 8100
Taiwan	0800 047 866
Thailand	1 800 226 008

Europe & Middle East

Austria	01 36027 71571
Belgium	32 (0) 2 404 93 40
Denmark	45 70 13 15 15
Finland	358 (0) 10 855 2100
France	0825 010 700*
	*0.125 €/minute
Germany	07031 464 6333
Ireland	1890 924 204
Israel	972-3-9288-504/544
Italy	39 02 92 60 8484
Netherlands	31 (0) 20 547 2111
Spain	34 (91) 631 3300
Sweden	0200-88 22 55
Switzerland	0800 80 53 53
United Kingdom	44 (0) 118 9276201

Other European Countries:

www.agilent.com/find/contactus

Revised: October 6, 2008

Product specifications and descriptions in this document subject to change without notice.

© Agilent Technologies, Inc. 2009
 Printed in USA, June 16, 2009
 5989-6433EN



Agilent Technologies