



Ordering number	CA12238		
Description	CA12238_Strada-FW-tape		
Family	Strada-Forward	FWHM	Asym degrees
Type	Lens	Efficiency	92 %
LED	MX-6	cd/lm	-
Color	Transparent	Gerber File	Available
Diameter	19.6+15.3 mm		
Height	10.9 mm		
Style	Rectangular		
Optic Material	PMMA		
Holder Material	-		
Fastening	Tape		
Status	Ready		

Ordering number	C12226		
Description	C12226_Strada-FW		
Family	Strada-Forward	FWHM	Asym degrees
Type	Lens	Efficiency	92 %
LED	MX-6	cd/lm	-
Color	Transparent	Gerber File	Available
Diameter	19.6+15.3 mm		
Height	10.9 mm		
Style	Rectangular		
Optic Material	PMMA		
Holder Material	-		
Fastening	Glue		
Status	Ready		

...ence will be changed by different color, chip size and chip position
... divergence is the full angle measured where the luminous intensity
is half of the peak value.



PRODUCT DATASHEET Strada-FW-N83 series



GENERAL INFORMATION

- Product series especially designed & optimized for MX-6 series of LEDs.
- Special care taken to make light distribution as uniform as possible.
- Lens material optical grade PMMA with high UV and temperature resistance (105 degrees of Celcius / 220 degrees of Fahrenheit). Allows use of high current and temperature conditions.

Please find more information about used material from below:

http://ledil.fi/sites/default/files/Documents/Technical/Material/PMMA%20N%20UL94_Yellow%20Card.pdf

<http://ledil.fi/sites/default/files/Documents/Technical/Material/PMMA%20N%20PLEXIGLAS-Datasheet.pdf>

- Fastening to heat sink with a PU foam adhesive tape of automotive grade. Please find fastening details by clicking link: http://www.ledil.com/datasheets/DataSheet_TAPE.pdf

- Fastening to PCB with appropriate adhesive. By clicking link below you can find Ledil recommended glue options.

http://www.ledil.com/datasheets/DataSheet_GLUES.pdf

NOTE 1: We advise customer to ensure the suitability and sufficiency of the bond in the end product. For example, mechanical stress, vibration and holes on the surface of the circuit board weaken the strength of the tape.

NOTE 2: Assembly to the surface must be made straight, so the tape bonds constant and balanced with fastening surface. Slanted assembly might cause unbalanced bond to the surface. All surfaces where tape is applied must be clean, dry and free from grease and dirt.

If cleaning of PCB surfaces is needed, please follow strictly the cleaning instructions of your LED manufacturer - this is important as cleaning shall under no circumstances damage LEDs or other electronics components on the PCB.

Further note that optical components shall not be cleaned with any chemicals - only micro fiber cloth may be used to remove fingerprints or other traces from handling.

NOTE 1: We advise customer to ensure the suitability and sufficiency of the bond in the end product. For example, mechanical stress, vibration and holes on the surface of the circuit board weaken the strength of the glue.

NOTE 2: All surfaces where glue is applied must be clean, dry and free from grease and dirt. If cleaning of PCB surfaces is needed, please follow strictly the cleaning instructions of your LED manufacturer -this is important as cleaning shall under no circumstances damage LEDs or other electronics components on the PCB.

Further note that optical components shall not be cleaned with any chemicals - only micro fiber cloth may be used to remove fingerprints or other traces from handling.

22

Luminaire: Ledil Oy C12226_Strada-FW_N083 C12226_Strada-FW_N083
Lamps: 1 x Nichia N083 6chip white

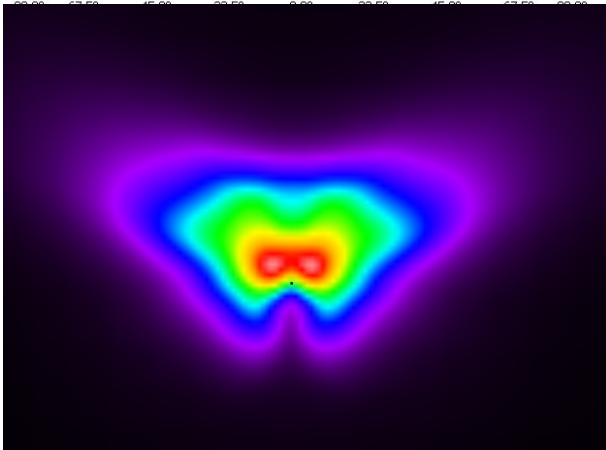
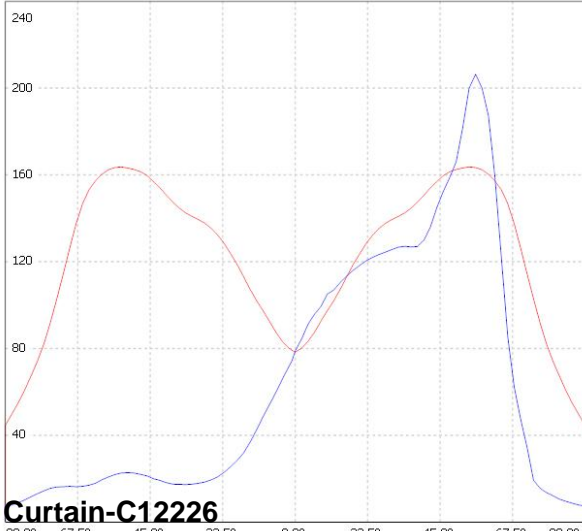

19

Luminaire: Ledil Oy C12226_Strada-FW_N083 C12226_Strada-FW_N083
Lamps: 1 x Nichia N083 6chip white

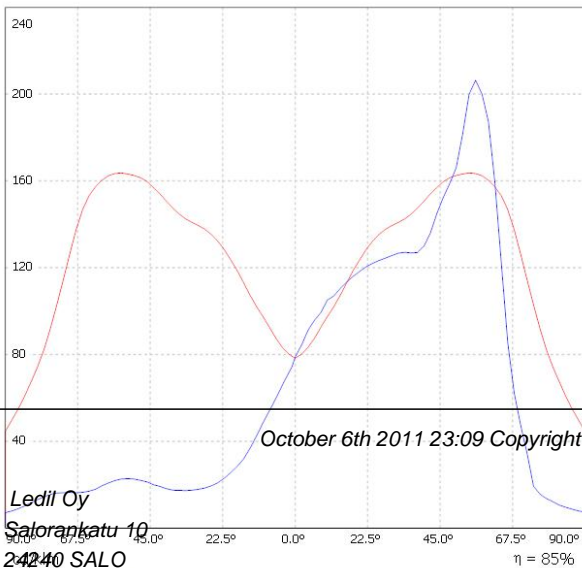

21

Luminaire: Ledil Oy C12226_Strada-FW_N083 C12226_Strada-FW_N083
Lamps: 1 x Nichia N083 6chip white

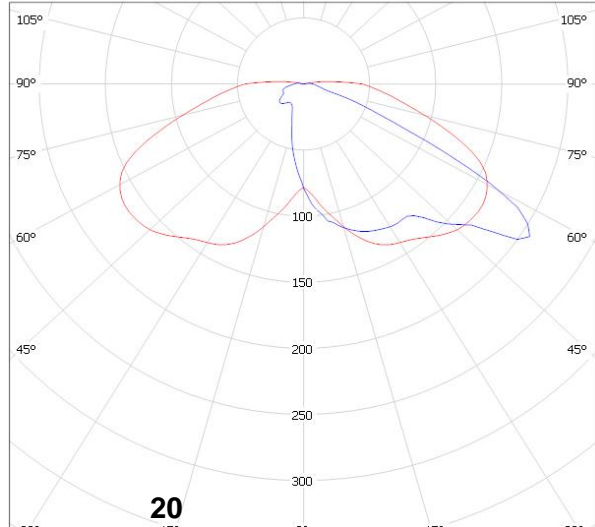

Luminaire: Ledil Oy C12226_Strada-FW_N083 C12226_Strada-FW_N083
Lamps: 1 x Nichia N083 6chip white

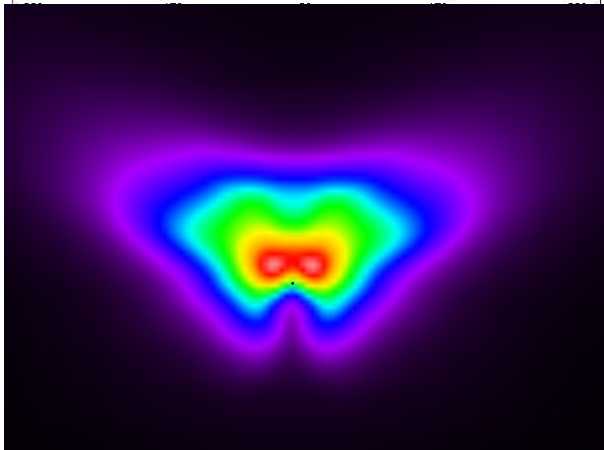
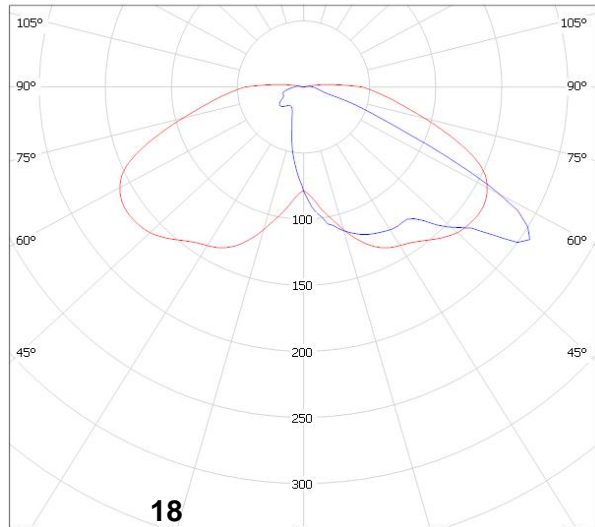

17

Luminaire: Ledil Oy C12086_Strada-FW-XP (XP-E)
Lamps: 1 x Cree XP-E 250mA 74.8 lm

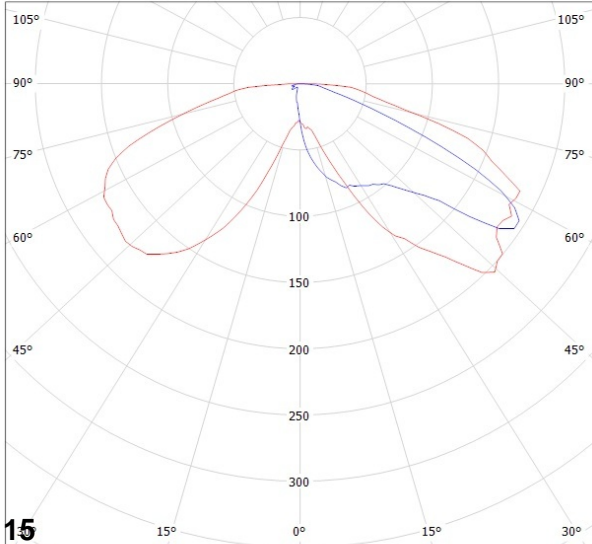

15

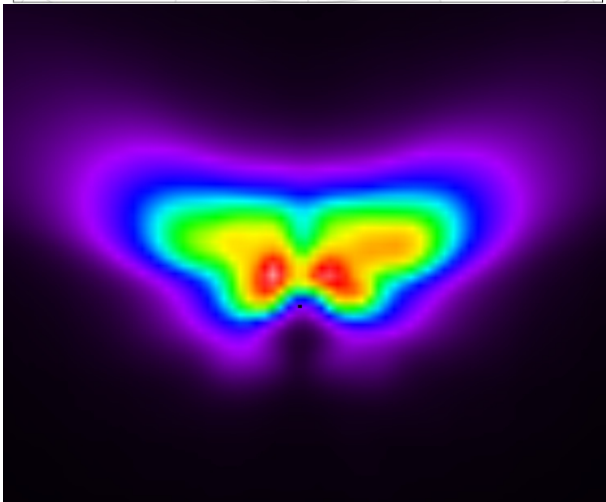

13

Luminaire: Ledil Oy C12086_Strada-FW-XP-G (XP-G)
Lamps: 1 x Cree XP-G 86.9 lm @ 250mA

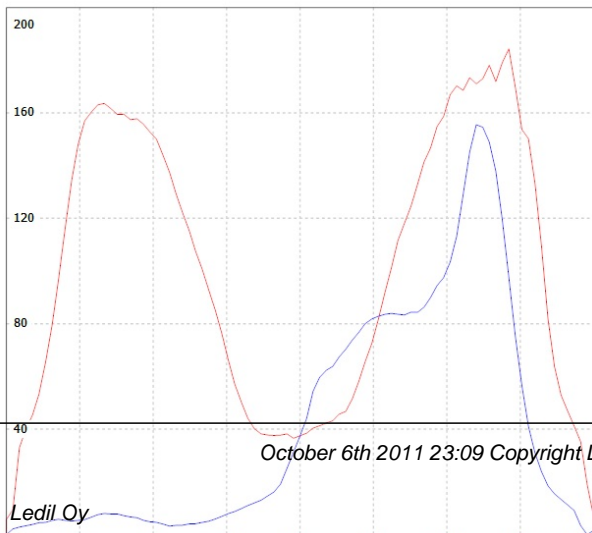

Ledil Oy
Salorankatu 10
24240 SALO
Finland

16

Luminaire: Ledil Oy C12086_Strada-FW-XP (XP-E)
Lamps: 1 x Cree XP-E 250mA 74.8 lm

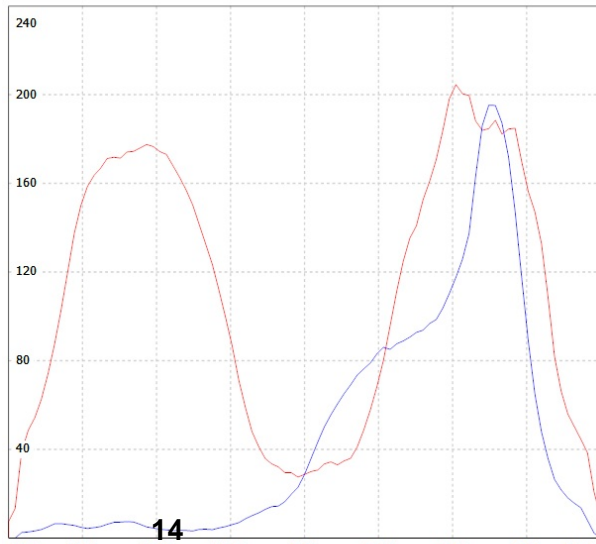

14

Luminaire: Ledil Oy C12086_Strada-FW-XP-G (XP-G)
Lamps: 1 x Cree XP-G 86.9 lm @ 250mA

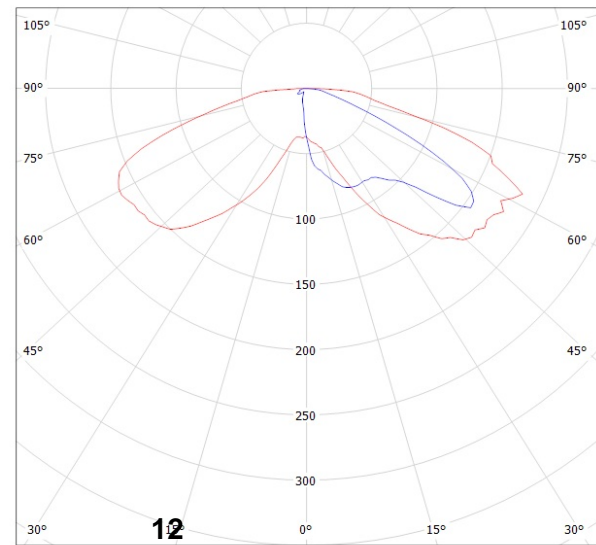

12

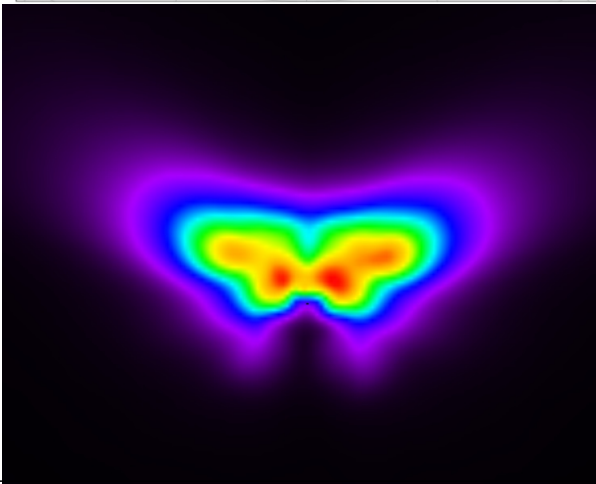

Polar-C12086

Luminaire: Ledil Oy C12086_Strada-FW-XP (XP-E)
Lamps: 1 x Cree XP-E 250mA 74.8 lm

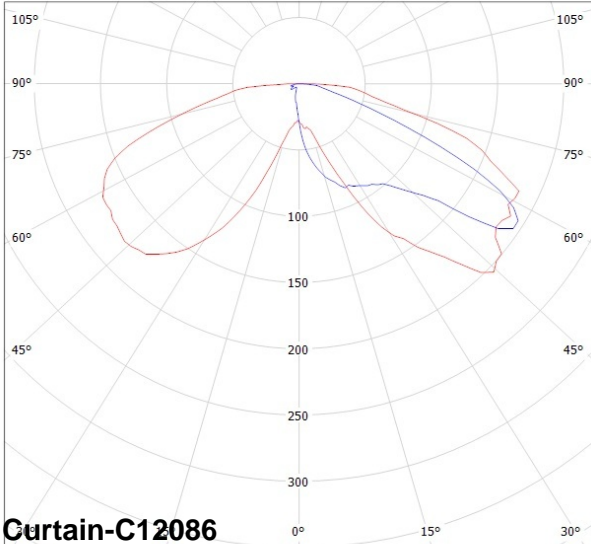

Curtain-C12086

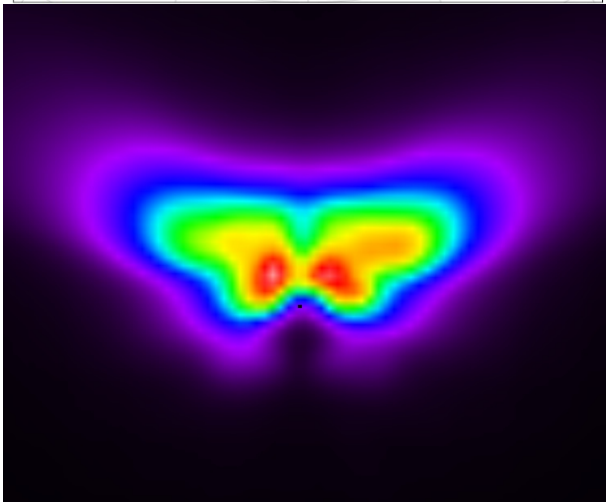

10

Luminaire: Ledil Oy C12086_Strada-FW-XP-G (XP-G)
Lamps: 1 x Cree XP-G 86.9 lm @ 250mA

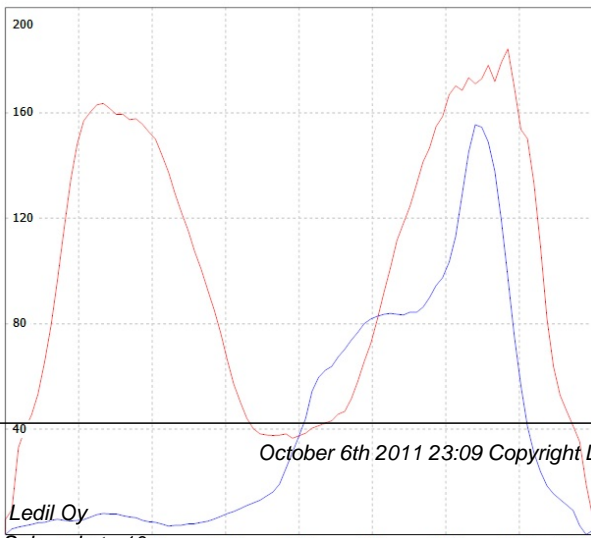

Ledil Oy
Salorankatu 10
24240 SALO
Finland

Linear-C12086

Luminaire: Ledil Oy C12086_Strada-FW-XP (XP-E)
Lamps: 1 x Cree XP-E 250mA 74.8 lm

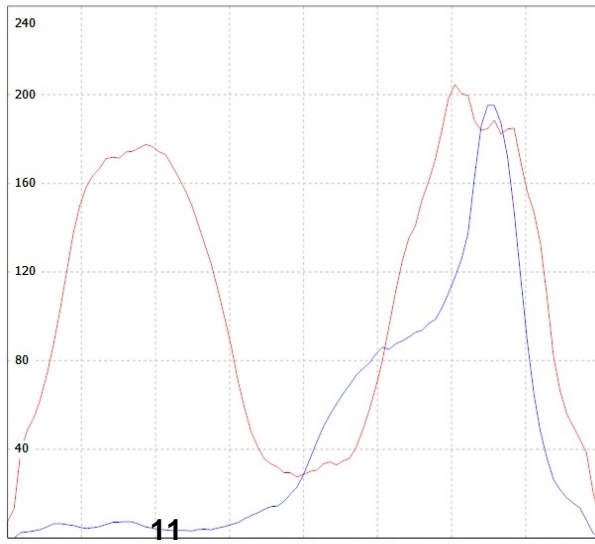

Luminaire: Ledil Oy C12086_Strada-FW-XP-G (XP-G)
Lamps: 1 x Cree XP-G 86.9 lm @ 250mA

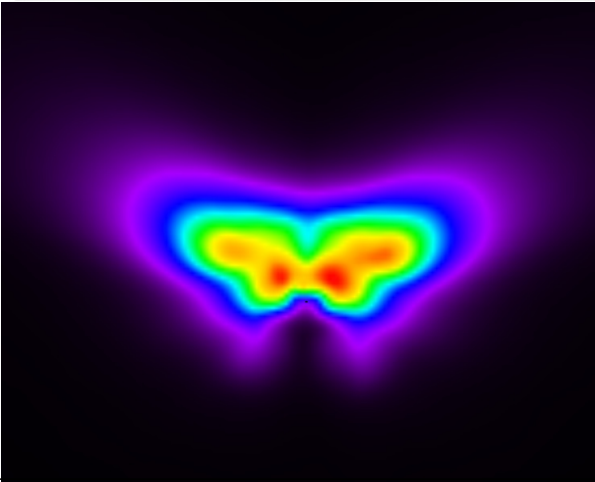
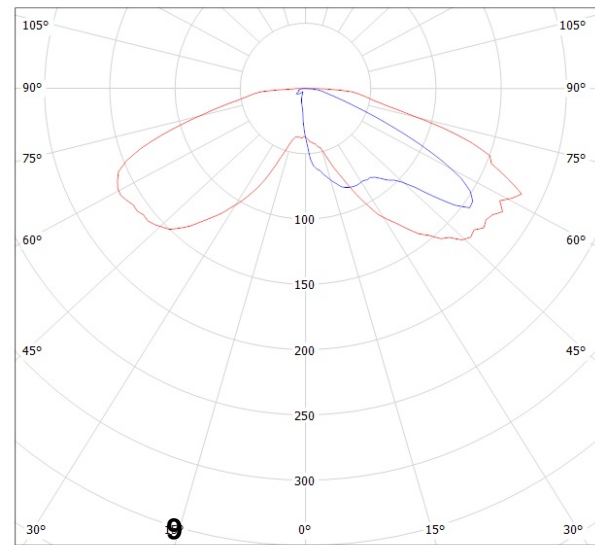

8

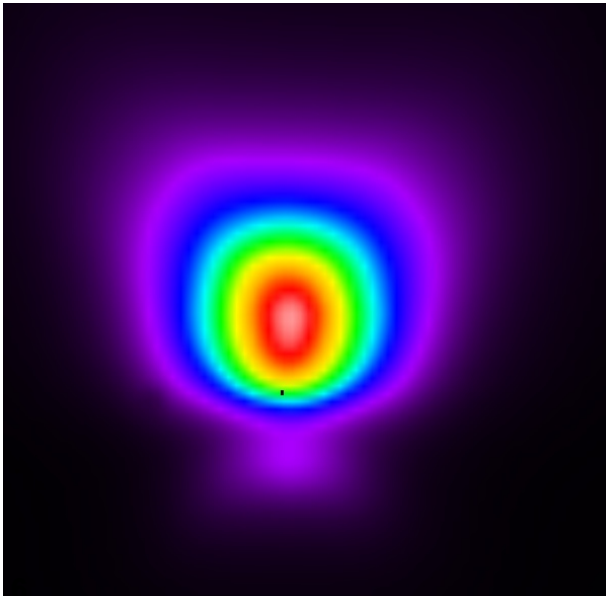

Luminaire: Ledil Oy C12049_Strada-FT-OSL C12049_Strada-FT-OSL
Lamps: 1 x LED Module

7

Luminaire: Ledil Oy C12049_Strada-FT-OSL C12049_Strada-FT-OSL
Lamps: 1 x LED Module

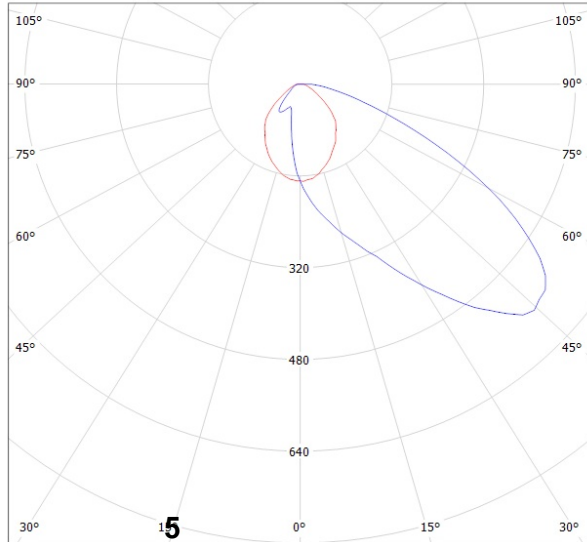

Luminaire: Ledil Oy C12049_Strada-FT-XP C12049_Strada-FT-XP
Lamps: 1 x Cree XP-E

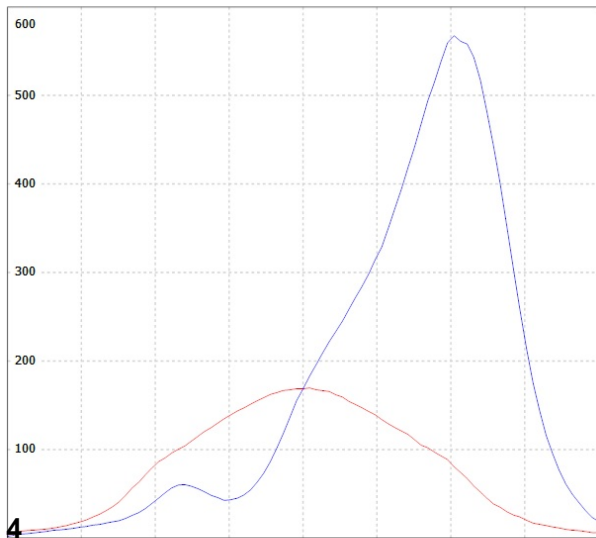

Luminaire: Ledil Oy C12049_Strada-FT-XP C12049_Strada-FT-XP
Lamps: 1 x Cree XP-E

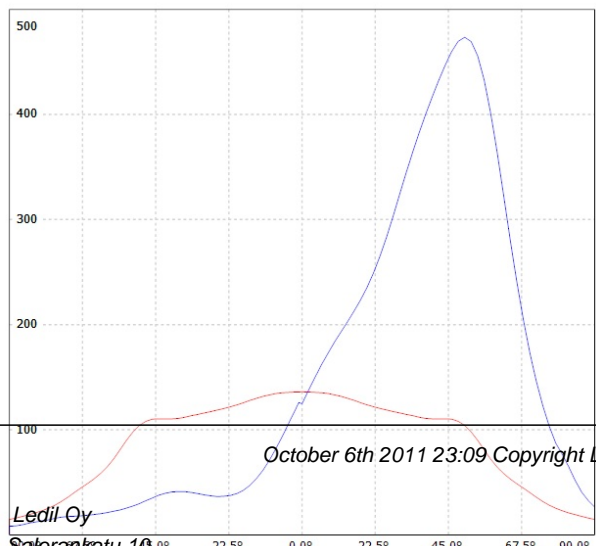
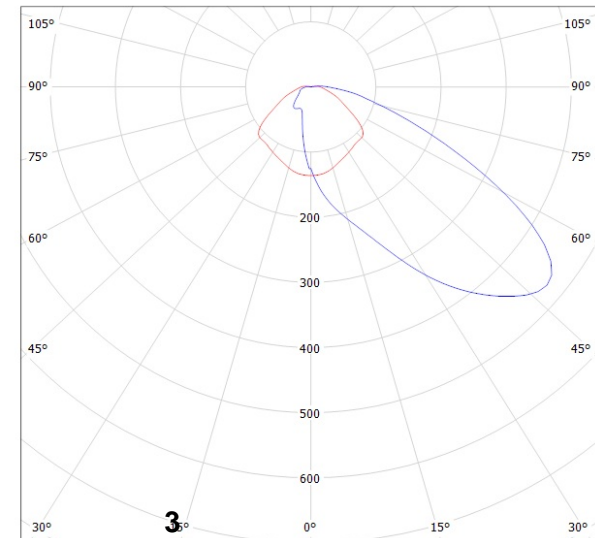

2

Luminaire: Ledil Oy C12049-Strada-FT-RE C12049-Strada-FT-RE
Lamps: 1 x LAMP]Luxeon Rebel 250mA 87lm

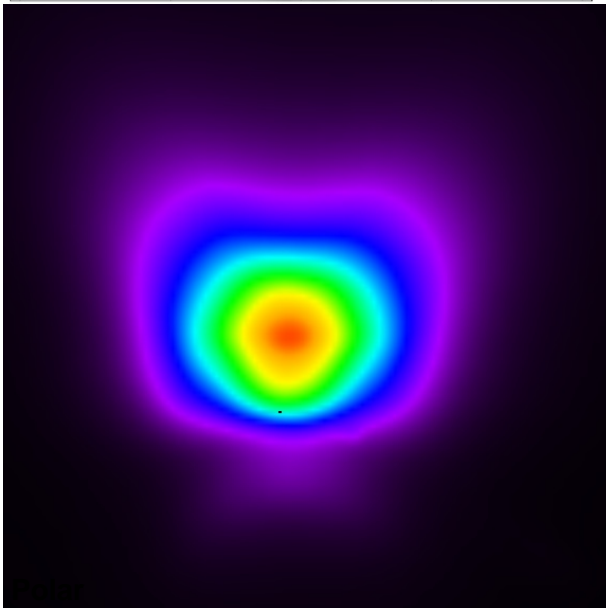
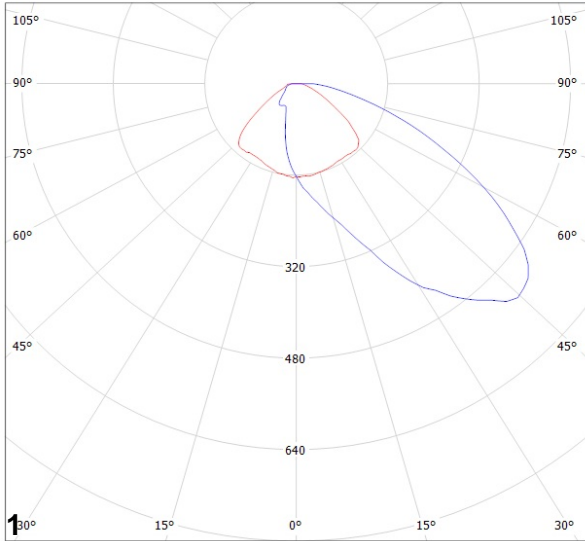

Luminaire: Ledil Oy C12049_Strada-FT-OSL C12049_Strada-FT-OSL
Lamps: 1 x LED Module

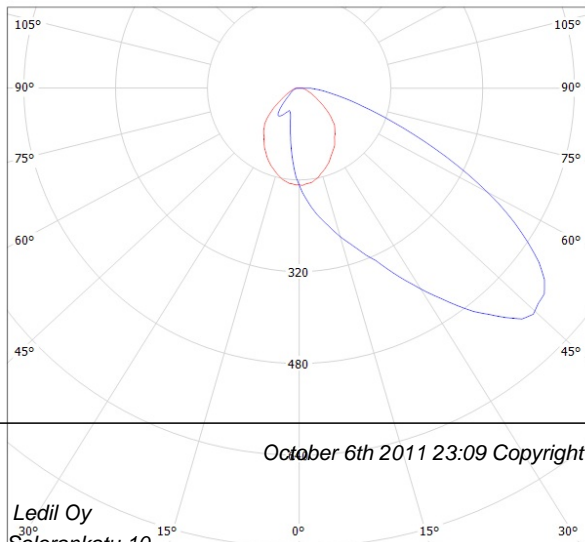

Ledil Oy
Salorankatu 10
24240 SALO
Finland

C90 - C270

linear

Luminaire: Ledil Oy C12049-Strada-FT-RE C12049-Strada-FT-RE
Lamps: 1 x LAMP]Luxeon Rebel 250mA 87lm

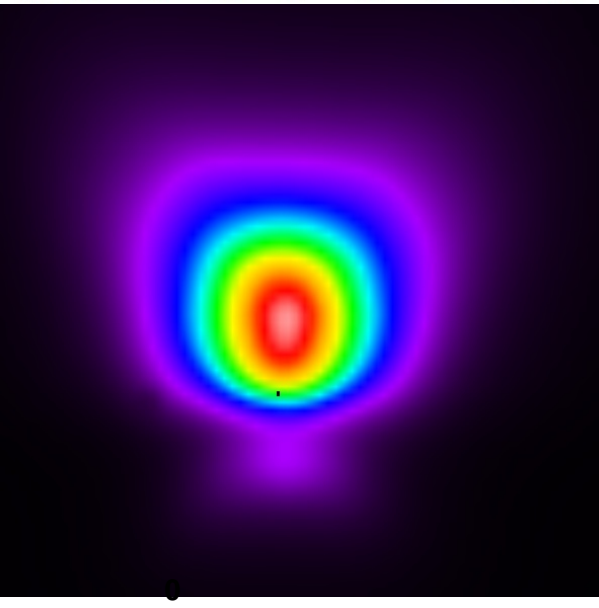
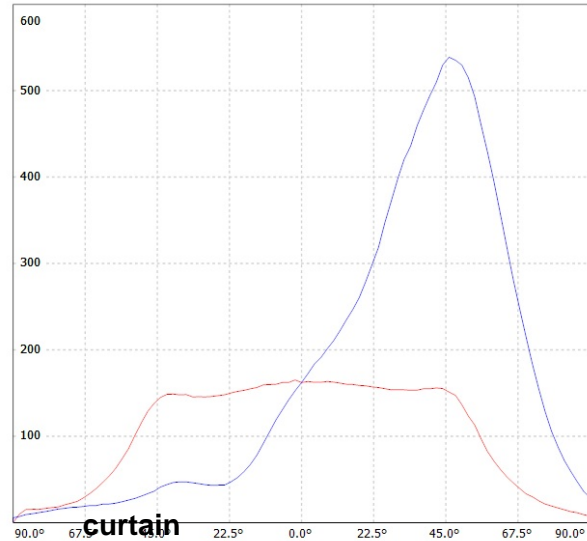

Luminaire: Ledil Oy C12049_Strada-FT-OSL C12049_Strada-FT-OSL
Lamps: 1 x LED Module

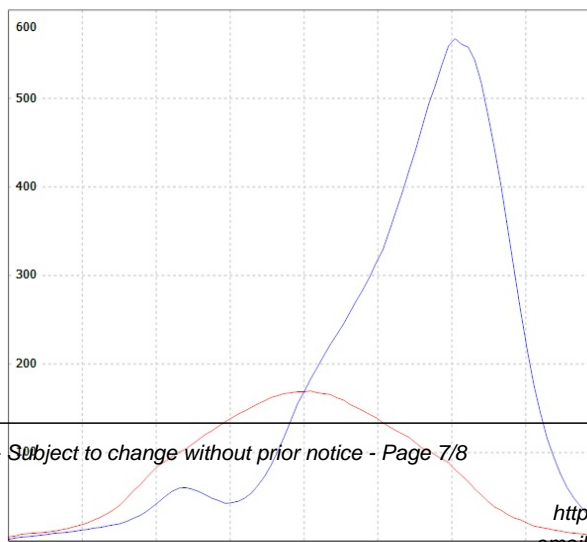

cd/km
C0 - C180 C90 - C270

polar

Luminaire: Ledil Oy C12049_Strada-FT-XP C12049_Strada-FT-XP
Lamps: 1 x Cree XP-E

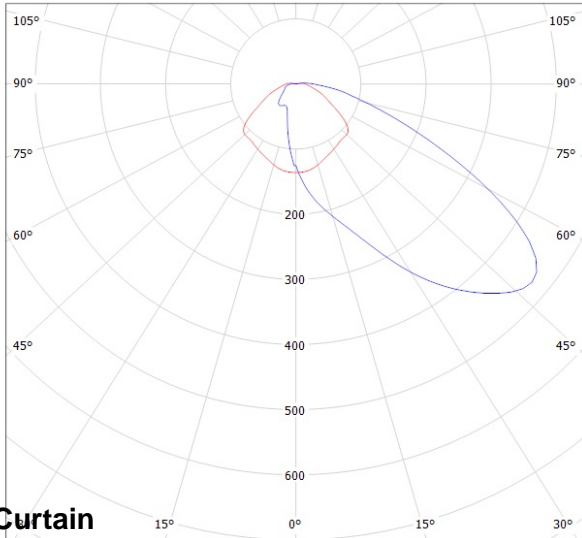

Curtain

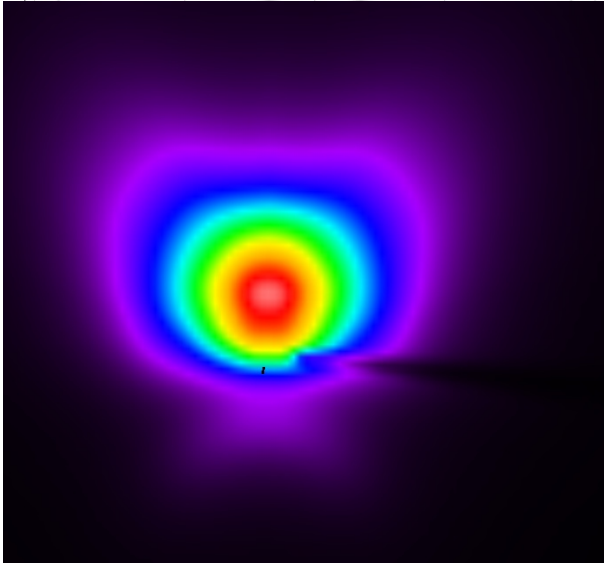

Linear

Luminaire: Ledil Oy C12049_Strada-FT-XP C12049_Strada-FT-XP
Lamps: 1 x Cree XP-E

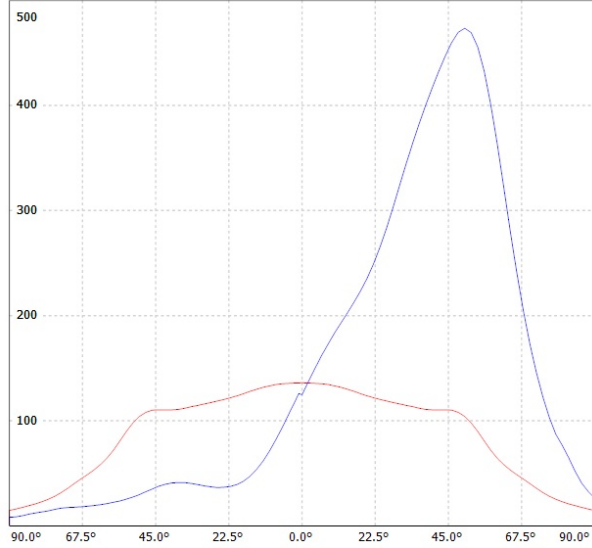

D

C

B

A

4

4

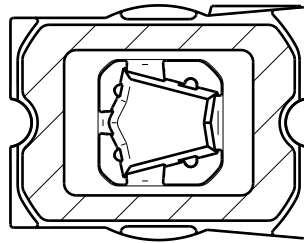

3

3

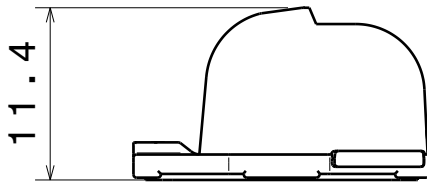

2

2

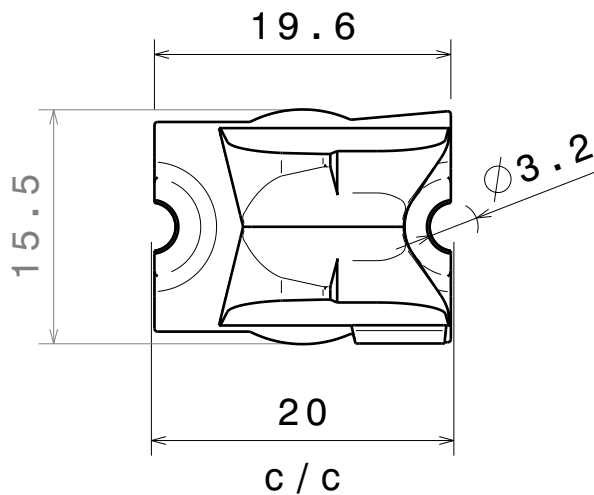

Top view
Scale: 2:1

MATERIALS
Lens: PMMA
tape: Pu foam with PSA

This drawing is our property.
It can't be reproduced
or communicated without
our written agreement.



Ledil Oy
Salorankatu 10
24240 SALO
Finland

DRAWING TITLE

Datasheet Strada-FW-N83 assy

DRAWN BY

pv

DATE

23.8.2011

CHECKED BY

ah

DATE

22.8.2011

SIZE

A4

DRAWING NUMBER

CA12238

REV

1

DESIGNED BY

hh

DATE

22.8.2011

SCALE

2:1

WEIGHT (g)

SHEET

1/1

D

A

1

1

D

C

B

A

4

4

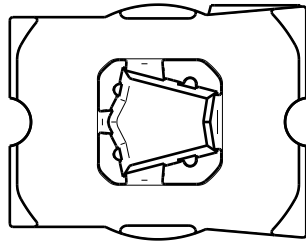

3

3

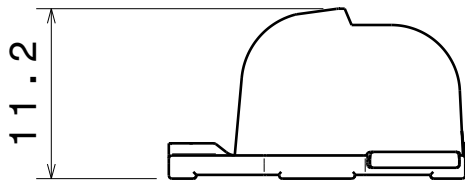

2

2

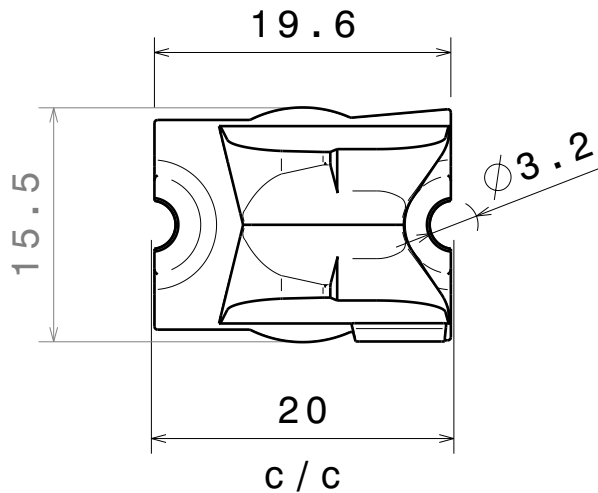

Top view
Scale: 2:1

MATERIALS
Lens: PMMA

This drawing is our property.
It can't be reproduced
or communicated without
our written agreement.



Ledil Oy
Salorankatu 10
24240 SALO
Finland

DRAWING TITLE

Datasheet Strada-FW-N83 lens

1

1

DRAWN BY

pv

DATE

23.8.2011

CHECKED BY

ah

DATE

22.8.2011

SIZE

A4

DRAWING NUMBER

C12226

REV

1

DESIGNED BY

hh

DATE

22.8.2011

SCALE

2:1

WEIGHT (g)

SHEET

1/1

D

A

D

C

B

A

4

4

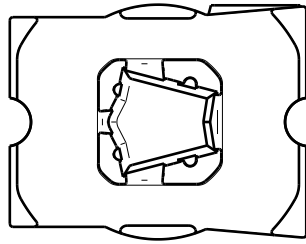

3

3

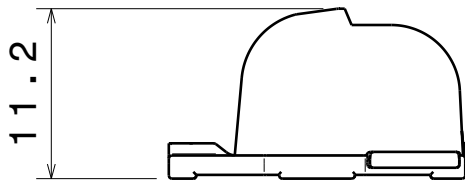

2

2

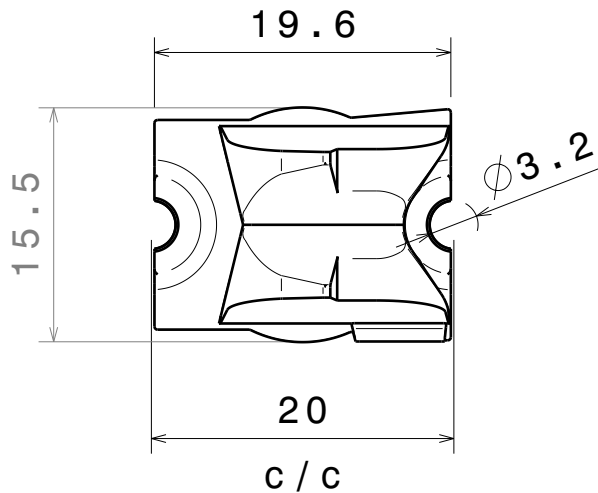

Top view
Scale: 2:1

MATERIALS
Lens: PMMA

This drawing is our property.
It can't be reproduced
or communicated without
our written agreement.



Ledil Oy
Salorankatu 10
24240 SALO
Finland

DRAWING TITLE

Datasheet Strada-FW-N83 lens

DRAWN BY

pv

DATE

23.8.2011

CHECKED BY

ah

DATE

22.8.2011

SIZE

A4

DRAWING NUMBER

C12226

REV

1

DESIGNED BY

hh

DATE

22.8.2011

SCALE

2:1

WEIGHT (g)

SHEET

1/1

D

A

1

1