

# Solid-state Timer H3M

CSM\_H3M\_DS\_E\_2\_1

## Solid-state Timer with Variable Time Ranges

- Four time ranges are selectable per timer unit.
- Wide timing range of 0.05 second to 30 hours can be covered by a combination of five timer units.
- Standard surface mounting type is easily convertible to flush mounting type with the use of a special adapter (Y92F-40).
- Requires only 40 x 50 mm for mounting space.
- Equipped with power-ON & time-out indicators.
- All standard models approved by UL, CSA, and LR.



## Ordering Information

Operation/resetting system	Time-limit contact	Instantaneous contact	Mounting	
			Surface mounting	Flush mounting
Time-limit operation/ self-resetting	DPDT	---	H3M	H3M with Y92F-40 adapter
	SPDT	SPDT	H3M-H	H3M-H with Y92F-40 adapter

- Note:** 1. Specify both the model number and supply voltage when ordering.  
 2. Sockets and adapters for surface/track mounting are available optionally and therefore, place the order for them as necessary.  
 Timer hold-down clips (F-hook and L-hook) are supplied with the timer.

## Accessories (Order Separately)









### Adapter









Y92F-40

## Specifications

### Time Ranges

Four time ranges are available for each timer by changing the time range selector switch positions to different combinations.

Time range code	Time range selector switch			
	× 1  s × 10  min	× 1  s × 10  min	× 1  s × 10  min	× 1  s × 10  min
<b>A</b>	0.05 to 0.5 s	0.5 to 5 s	0.05 to 0.5 min	0.5 to 5 min
<b>B</b>	0.1 to 1 s	1 to 10 s	0.1 to 1 min	1 to 10 min
<b>C</b>	0.3 to 3 s	3 to 30 s	0.3 to 3 min	3 to 30 min

Time range code	Time multiplying key			
	× 1  min × 10  h	× 1  min × 10  h	× 1  min × 10  h	× 1  min × 10  h
<b>D</b>	0.1 to 1 min	1 to 10 min	0.1 to 1 hrs	1 to 10 hrs
<b>E</b>	0.3 to 3 min	3 to 30 min	0.3 to 3 hrs	3 to 30 hrs

## ■ Ratings

<b>Rated supply voltage</b>	100/110/120 VAC (50/60 Hz), 200/220/240 VAC (50/60 Hz), 12, 24, 48, 100, 110 VDC (see note 2)
<b>Operating voltage range</b>	AC: 85% to 110% of rated supply voltage DC: 80% to 110% of rated supply voltage (see note 3)
<b>Power consumption</b>	AC: Approx. 5 VA/2 W DC: Approx. 2 W
<b>Control outputs</b>	5 A at 250 VAC, resistive load ( $\cos\phi = 1$ )

- Note:** 1. Color indicators for the rated voltage are provided on the front of the Timer.  
Blue: 100/110/120 VAC  
Red: 200/220/240 VAC  
None: Other voltages
2. With DC ratings, single-phase full-wave rectified power sources may be used.
3. 90% to 110% for 12-VDC models.

## ■ Characteristics

<b>Accuracy of operating time</b>	$\pm 1\%$ max. (see note)
<b>Setting error</b>	$\pm 10\%$ max.
<b>Reset time</b>	0.1 s max.
<b>Influence of voltage</b>	$\pm 1\%$ max. (see note)
<b>Influence of temperature</b>	$\pm 2\%$ max. (see note)
<b>Insulation resistance</b>	100 M $\Omega$ min. (at 500 VDC)
<b>Dielectric strength</b>	2,000 VAC, 50/60 Hz for 1 min (between current-carrying and non-current-carrying parts) 1,500 VAC, 50/60 Hz for 1 min (between contact and control circuit) 1,000 VAC, 50/60 Hz for 1 min (between non-continuous contacts)
<b>Vibration resistance</b>	Destruction: 10 to 55 Hz with 0.75-mm double amplitude Malfunction: 10 to 55 Hz with 0.5-mm double amplitude
<b>Shock resistance</b>	Destruction: 1,000 m/s <sup>2</sup> (approx. 100G) Malfunction: 100 m/s <sup>2</sup> (approx. 10G)
<b>Ambient temperature</b>	Operating: $-10^{\circ}\text{C}$ to $50^{\circ}\text{C}$ Storage: $-25^{\circ}\text{C}$ to $65^{\circ}\text{C}$
<b>Ambient humidity</b>	Operating: 35% to 85%
<b>Life expectancy</b>	Mechanical: 20,000,000 operations min. (under no load at 1,800 operations/h) Electrical: 100,000 operations min. (5 A at 250 VAC, resistive load at 1,800 operations/h)
<b>Approved standards</b>	UL (File No. E41515), CSA (File No. LR22310)
<b>Weight</b>	Approx. 100 g

- Note:** For the timer with time range code A, add  $\pm 10$  ms to the respective characteristics when the time range selector switches are in the x 1 s (0.05 to 0.5 s) position.

# Engineering Data

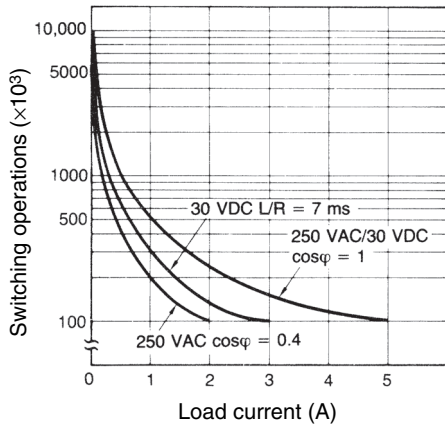

Reference: A maximum current of 0.15 A can be switched at 125 VDC (cosφ = 1). Maximum current of 0.1 A can be switched if L/R is 7 ms. In both cases, a life of 100,000 operations can be expected. The minimum applicable load is 10 mA at 5 VDC (failure level: P).

# Operation

## ■ Timing Chart

H3M

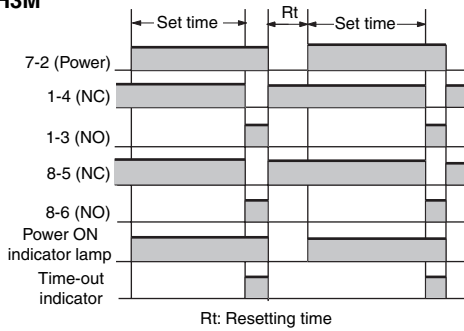

H3M-H

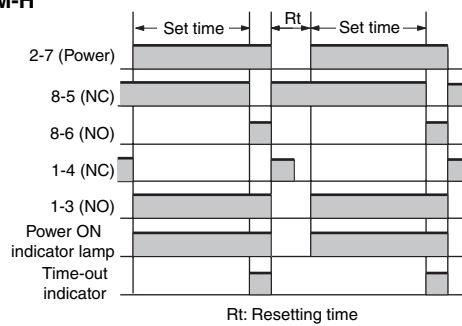

# Dimensions

Note: All units are in millimeters unless otherwise indicated.

## H3M(-H)

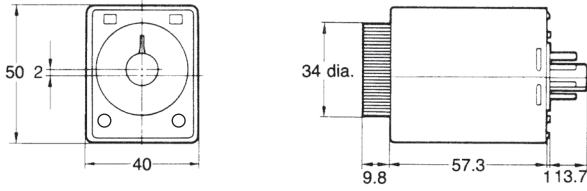

## Accessories (Order Separately)

### Y92F-40 Adapter with Flush Mounting

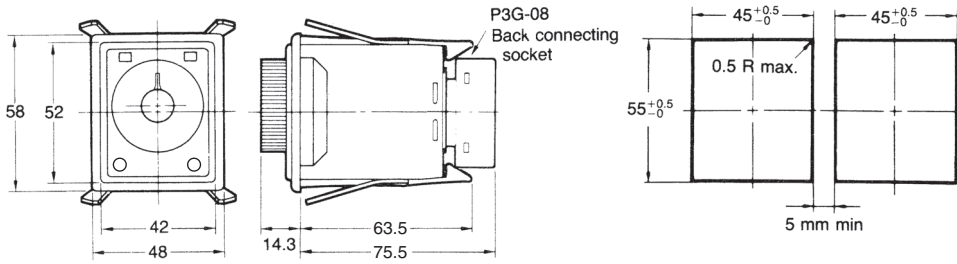

Note: When two or more timers mounted in line are to be continuously energized at the same time after the lapse of the set time, be sure to limit the carry current to less than 1 A. When using the timers at an ambient temperature of more than 40°C, be sure to reset the timers immediately after the set time has elapsed.

### Track Mounted/Front Connecting Socket

#### PF085A

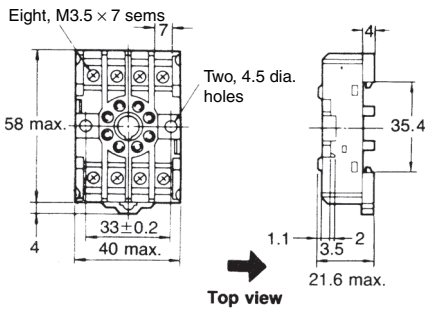

#### Terminal Arrangement (Top View)

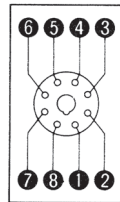

#### Mounting Holes

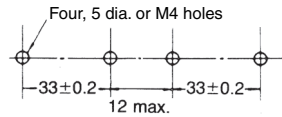

#### Mounting Height of Timer with Socket

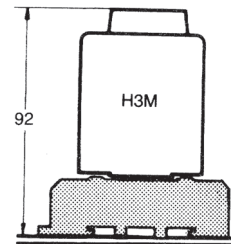

Note: PF085A can be used as a front connecting socket.

### Hold-down Clips (Attached)

#### PHC-1 For PF085A

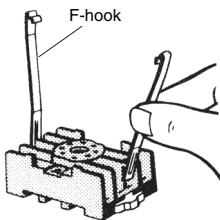

## Back Connecting Socket PL08

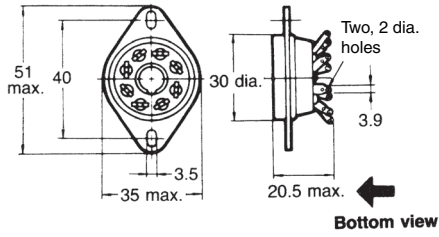

### Terminal Arrangement (Bottom View)

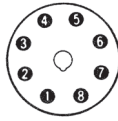

### Mounting Holes

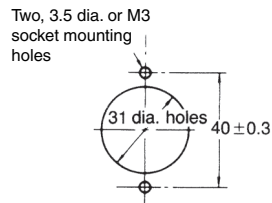

### Mounting Height of Timer with Socket

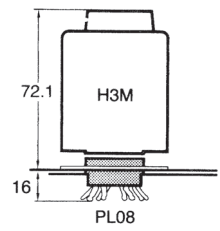

## P3G-08

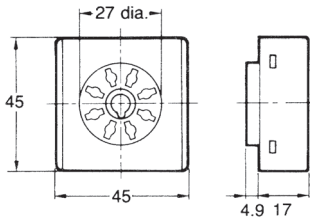

### Terminal Arrangement (Bottom View)

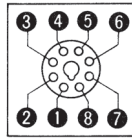

### Mounting Height of Timer with Socket

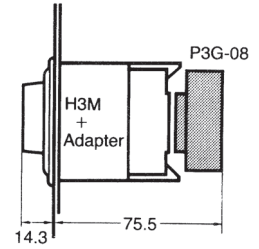

## Mounting Track PFP-100N/PFP-50N

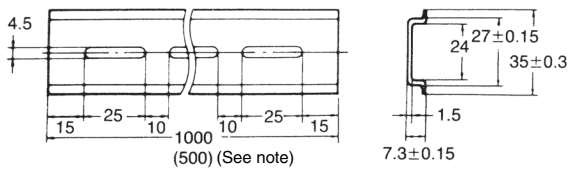

## End Plate PFP-M

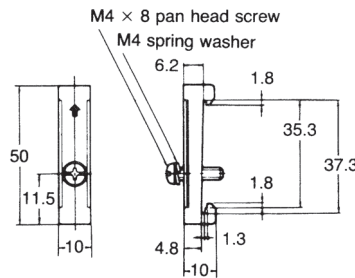

## Spacer PFP-S

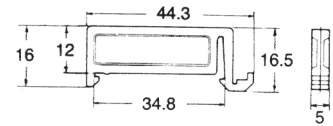

**Note:** This dimension applies to PFP-50N.

# Installation

## ■ Connection

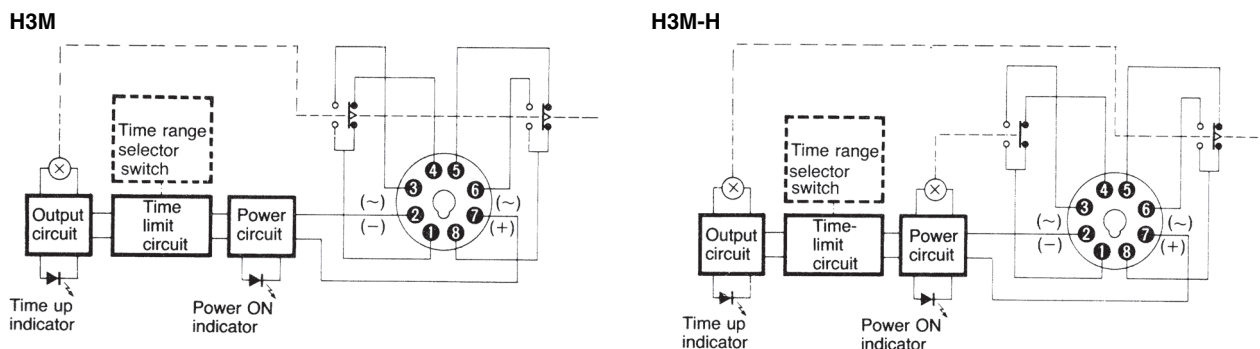

## Safety Precautions

Refer to *Safety Precautions for All Timers*.

### Power Source Connection

Because the AC-operated version is a capacitive load, the solid-state relay to be used must be rated at a dielectric strength two times as that of the timer to switch the power source of the timer.

The H3M contains a capacitor-drop power circuit. Use a sinusoidal power supply with a commercial frequency. Do not use power supplies with a high frequency component (such as inverter power supplies) for Timers with 100 to 240-VAC specifications. Using these power supplies can damage internal circuits.

### How to Change the Time Range

The H3M is provided with two time range selector switches. One is on the lower right side A of the front panel and the other on the lower left side. Change the positional combination of the time range selector switches with a flat-blade screwdriver as desired.

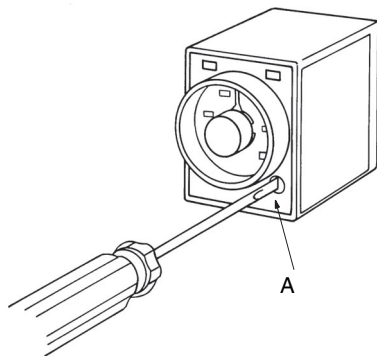

### ⚠ CAUTION

Be sure to turn the power off before changing the time specification. Changing the time range while the timer is in operation may result in a malfunction.

### Connections

#### Connecting the Operating Power Supply

If using an AC power supply, connect it between terminals 2 and 7. If using a DC power supply, connect the positive line to terminal 7 and the negative line to terminal 2. An AC power supply can be connected without considering polarity, but the DC power supply lines must be connected as specified.

### Other Precautions

- A DC power supply must have 50% or less ripple and the average voltage must be within the rated supply voltage specification.
- A P3G-08 Socket can be used instead of a US-08 Socket to reduce the depth. Also, the P3G-08 has screw terminals, making maintenance easier.

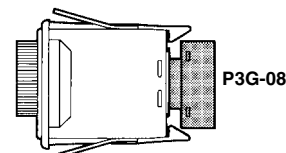
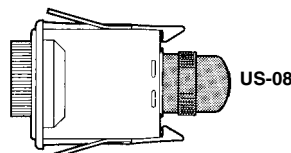

ALL DIMENSIONS SHOWN ARE IN MILLIMETERS.

To convert millimeters into inches, multiply by 0.03937. To convert grams into ounces, multiply by 0.03527.

In the interest of product improvement, specifications are subject to change without notice.

## Read and Understand This Catalog

Please read and understand this catalog before purchasing the products. Please consult your OMRON representative if you have any questions or comments.

## Warranty and Limitations of Liability

### WARRANTY

OMRON's exclusive warranty is that the products are free from defects in materials and workmanship for a period of one year (or other period if specified) from date of sale by OMRON.

OMRON MAKES NO WARRANTY OR REPRESENTATION, EXPRESS OR IMPLIED, REGARDING NON-INFRINGEMENT, MERCHANTABILITY, OR FITNESS FOR PARTICULAR PURPOSE OF THE PRODUCTS. ANY BUYER OR USER ACKNOWLEDGES THAT THE BUYER OR USER ALONE HAS DETERMINED THAT THE PRODUCTS WILL SUITABLY MEET THE REQUIREMENTS OF THEIR INTENDED USE. OMRON DISCLAIMS ALL OTHER WARRANTIES, EXPRESS OR IMPLIED.

### LIMITATIONS OF LIABILITY

OMRON SHALL NOT BE RESPONSIBLE FOR SPECIAL, INDIRECT, OR CONSEQUENTIAL DAMAGES, LOSS OF PROFITS OR COMMERCIAL LOSS IN ANY WAY CONNECTED WITH THE PRODUCTS, WHETHER SUCH CLAIM IS BASED ON CONTRACT, WARRANTY, NEGLIGENCE, OR STRICT LIABILITY.

In no event shall the responsibility of OMRON for any act exceed the individual price of the product on which liability is asserted.

IN NO EVENT SHALL OMRON BE RESPONSIBLE FOR WARRANTY, REPAIR, OR OTHER CLAIMS REGARDING THE PRODUCTS UNLESS OMRON'S ANALYSIS CONFIRMS THAT THE PRODUCTS WERE PROPERLY HANDLED, STORED, INSTALLED, AND MAINTAINED AND NOT SUBJECT TO CONTAMINATION, ABUSE, MISUSE, OR INAPPROPRIATE MODIFICATION OR REPAIR.

## Application Considerations

### SUITABILITY FOR USE

OMRON shall not be responsible for conformity with any standards, codes, or regulations that apply to the combination of products in the customer's application or use of the products.

At the customer's request, OMRON will provide applicable third party certification documents identifying ratings and limitations of use that apply to the products. This information by itself is not sufficient for a complete determination of the suitability of the products in combination with the end product, machine, system, or other application or use.

The following are some examples of applications for which particular attention must be given. This is not intended to be an exhaustive list of all possible uses of the products, nor is it intended to imply that the uses listed may be suitable for the products:

- Outdoor use, uses involving potential chemical contamination or electrical interference, or conditions or uses not described in this catalog.
- Nuclear energy control systems, combustion systems, railroad systems, aviation systems, medical equipment, amusement machines, vehicles, safety equipment, and installations subject to separate industry or government regulations.
- Systems, machines, and equipment that could present a risk to life or property.

Please know and observe all prohibitions of use applicable to the products.

NEVER USE THE PRODUCTS FOR AN APPLICATION INVOLVING SERIOUS RISK TO LIFE OR PROPERTY WITHOUT ENSURING THAT THE SYSTEM AS A WHOLE HAS BEEN DESIGNED TO ADDRESS THE RISKS, AND THAT THE OMRON PRODUCTS ARE PROPERLY RATED AND INSTALLED FOR THE INTENDED USE WITHIN THE OVERALL EQUIPMENT OR SYSTEM.

### PROGRAMMABLE PRODUCTS

OMRON shall not be responsible for the user's programming of a programmable product, or any consequence thereof.

## Disclaimers

### CHANGE IN SPECIFICATIONS

Product specifications and accessories may be changed at any time based on improvements and other reasons.

It is our practice to change model numbers when published ratings or features are changed, or when significant construction changes are made. However, some specifications of the products may be changed without any notice. When in doubt, special model numbers may be assigned to fix or establish key specifications for your application on your request. Please consult with your OMRON representative at any time to confirm actual specifications of purchased products.

### DIMENSIONS AND WEIGHTS

Dimensions and weights are nominal and are not to be used for manufacturing purposes, even when tolerances are shown.

### PERFORMANCE DATA

Performance data given in this catalog is provided as a guide for the user in determining suitability and does not constitute a warranty. It may represent the result of OMRON's test conditions, and the users must correlate it to actual application requirements. Actual performance is subject to the OMRON Warranty and Limitations of Liability.

### ERRORS AND OMISSIONS

The information in this document has been carefully checked and is believed to be accurate; however, no responsibility is assumed for clerical, typographical, or proofreading errors, or omissions.

2008.11

In the interest of product improvement, specifications are subject to change without notice.

**OMRON Corporation**  
Industrial Automation Company

<http://www.ia.omron.com/>

(c)Copyright OMRON Corporation 2008 All Right Reserved.