

**MAXIM**

# Current-Limited, High-Side P-Channel Switches with Thermal Shutdown

## General Description

The MAX891L/MAX892L smart, low-voltage, P-channel, MOSFET power switches are intended for high-side load-switching applications. These switches operate with inputs from 2.7V to 5.5V, making them ideal for both 3V and 5V systems. Internal current-limiting circuitry protects the input supply against overload. Thermal-overload protection limits power dissipation and junction temperatures.

The MAX891L/MAX892L's maximum current limits are 500mA and 250mA, respectively. The current limit through the switch is programmed with a resistor from SET to ground. When the switch is on, the quiescent supply current is a low 13 $\mu$ A. When the switch is off, the quiescent current decreases to 0.1 $\mu$ A.

The MAX891L/MAX892L are available in 8-pin  $\mu$ MAX packages.

## Applications

PCMCIA Slots  
Access Bus Slots  
Portable Equipment

## Features

- ◆ Ultra-Small  $\mu$ MAX Package—Only 1.11mm High
- ◆ 2.7V to 5.5V Input Range
- ◆ Programmable Current Limit
- ◆ Low 13 $\mu$ A Quiescent Current at  $V_{IN} = 3.3V$ , 0.1 $\mu$ A Switch Off
- ◆ Thermal Shutdown
- ◆ FAULT Indicator Output
- ◆ On-Resistances:  
0.12 $\Omega$  (MAX891L)  
0.25 $\Omega$  (MAX892L)

## Ordering Information

PART	TEMP. RANGE	PIN-PACKAGE	CURRENT LIMIT
MAX891LC/D	0°C to +70°C	Dice**	500mA
MAX891LEUA*	-40°C to +85°C	8 $\mu$ MAX	500mA
MAX892LC/D	0°C to +70°C	Dice**	250mA
MAX892LEUA*	-40°C to +85°C	8 $\mu$ MAX	250mA

\* To order these units in tape and reel, add (-T) to the end of the part number.

\*\* Dice are tested at  $T_A = +25^\circ\text{C}$ .

## Typical Operating Circuit

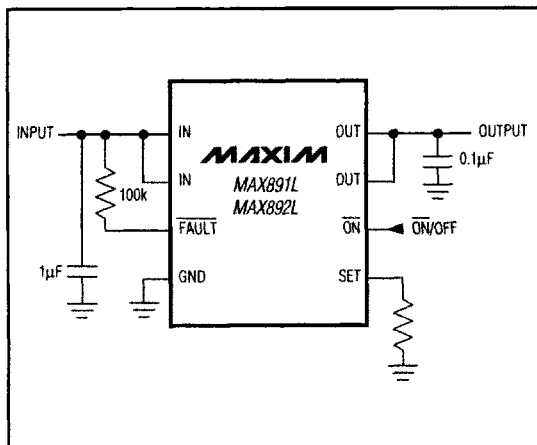

## Pin Configuration

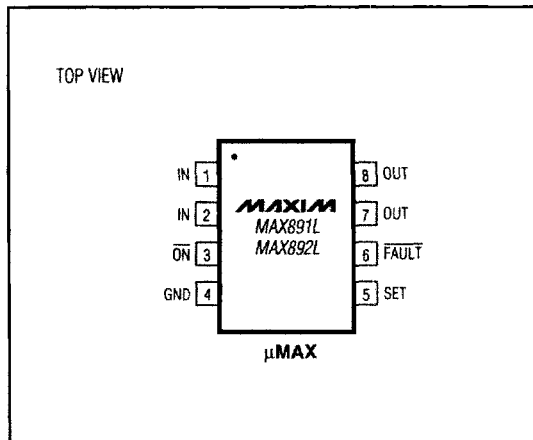

MAX891L/MAX892L

4

**MAXIM**

Maxim Integrated Products 4-87

For free samples & the latest literature: <http://www.maxim-ic.com>, or phone 1-800-998-8800

# Current-Limited, High-Side P-Channel Switches with Thermal Shutdown

## ABSOLUTE MAXIMUM RATINGS

IN to GND .....	-0.3V to 6V	Continuous Power Dissipation (TA = +70°C)	
ON, FAULT to GND .....	-0.3V to 6V	µMAX (derate 4.1mW/°C above +70°C) .....	330mW
SET, OUT to GND .....	-0.3V to (VIN + 0.3V)	Operating Temperature Range	
Maximum Continuous Switch Current		MAX891LEUA/MAX892LEUA .....	-40°C to +85°C
MAX891L .....	0.75A	Storage Temperature Range .....	-65°C to +150°C
MAX892L .....	0.375A	Lead Temperature (soldering, 10sec) .....	+300°C

Stresses beyond those listed under "Absolute Maximum Ratings" may cause permanent damage to the device. These are stress ratings only, and functional operation of the device at these or any other conditions beyond those indicated in the operational sections of the specifications is not implied. Exposure to absolute maximum rating conditions for extended periods may affect device reliability.

## ELECTRICAL CHARACTERISTICS

(VIN = 3V, TA = 0°C to +85°C, unless otherwise noted. Typical values are at TA = +25°C.)

PARAMETER	CONDITIONS		MIN	TYP	MAX	UNITS
Operating Voltage			2.7		5.5	V
Quiescent Current	VIN = 5V, ON = GND, IOUT = 0mA			13	20	µA
Off-Supply Current	ON = IN, VIN = VOUT = 5.5V			0.02	1	µA
Off-Switch Current	ON = IN, VIN = 5.5V, VOUT = 0V			0.02	3	µA
Undervoltage Lockout	Rising edge, 1% hysteresis		2.0	2.3	2.6	V
On-Resistance	VIN = 4.5V	MAX891L		120	225	mΩ
		MAX892L		250	420	
	VIN = 3.0V	MAX891L		150	300	mΩ
		MAX892L		300	500	
Current-Limit-Amplifier Accuracy	VSET required to turn the switch off (Note 1)		1.178	1.240	1.302	V
Maximum Output Current	MAX891L			500		mA
	MAX892L			250		
IOUT to ISET Current Ratio	VOUT = 1.6V to 2.8V	MAX891L, IOUT = 250mA	840	965	1130	A/A
		MAX892L, IOUT = 125mA	840	965	1130	
ON Input Low Voltage	VIN = 2.7V to 5.5V				0.8	V
ON Input High Voltage	VIN = 2.7V to 3.6V		2.0			V
	VIN = 4.5V to 5.5V		2.4			
ON Input Leakage	VON = 5.5V		-1	0.01	1	µA
ISET Bias Current	VSET = 1.24V, IOUT = 0mA			0.5	3	µA
FAULT Logic Output Low Voltage	ISINK = 1mA, VSET = 1.4V				0.4	V
FAULT Logic Output High Leakage	VFAULT = 5.5V, VSET = 1V			0.05	1	µA
Slow-Current-Loop Response Time	20% current overdrive, VIN = 5V			5		µs
Fast-Current-Loop Response Time				2		µs
Turn-On Time	IOUT = 250mA (MAX891L), or 125mA (MAX892L)	VIN = 5V		100	200	µs
		VIN = 3V		150		
Turn-Off Time	VIN = 5V		0.8	2	20	µs

# Current-Limited, High-Side P-Channel Switches with Thermal Shutdown

MAX891L/MAX892L

## ELECTRICAL CHARACTERISTICS

( $V_{IN} = 3V$ ,  $T_A = -40^{\circ}C$  to  $+85^{\circ}C$ , unless otherwise noted.) (Note 2)

PARAMETER	CONDITIONS		MIN	TYP	MAX	UNITS
Operating Voltage			3.0		5.5	V
Quiescent Current	$V_{IN} = 5V$ , $\overline{ON} = GND$ , $I_{OUT} = 0mA$				50	$\mu A$
Off-Supply Current	$\overline{ON} = IN$ , $V_{IN} = V_{OUT} = 5.5V$				2.2	$\mu A$
Off-Switch Current	$\overline{ON} = IN$ , $V_{IN} = 5.5V$ , $V_{OUT} = 0V$				8	$\mu A$
Undervoltage Lockout	Rising edge, 1% hysteresis		2.0		2.9	V
On-Resistance	$V_{IN} = 4.5V$	MAX891L			225	m $\Omega$
		MAX892L			420	
	$V_{IN} = 3.0V$	MAX891L			300	m $\Omega$
		MAX892L			500	
Current-Limit-Amplifier Accuracy	$V_{SET}$ required to turn the switch off (Note 1)		1.14		1.34	V
$I_{OUT}$ to $I_{SET}$ Current Ratio	$V_{OUT} = 1.6V$ to $2.8V$	MAX891L, $I_{OUT} = 250mA$	805		1210	A/A
		MAX892L, $I_{OUT} = 125mA$	805		1210	
FAULT Logic Output Low Voltage	$I_{SINK} = 1mA$ , $V_{SET} = 1.4V$				0.4	V
Turn-On Time	$V_{IN} = 5V$				200	$\mu s$
Turn-Off Time	$V_{IN} = 5V$		0.25		20	$\mu s$

**Note 1:** Tested with  $I_{OUT} = 50mA$  for the MAX891L, 25mA for the MAX892L, and  $V_{SET}$  raised until  $V_{IN} - V_{OUT} \geq 0.8V$ .

**Note 2:** Parameters to  $-40^{\circ}C$  are guaranteed by design, not production tested.

# Current-Limited, High-Side P-Channel Switches with Thermal Shutdown

## Typical Operating Characteristics

(Typical Operating Circuit,  $T_A = +25^\circ\text{C}$ , unless otherwise noted.)

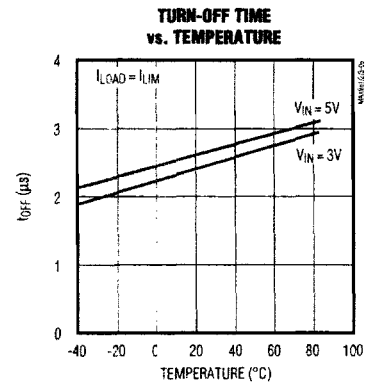
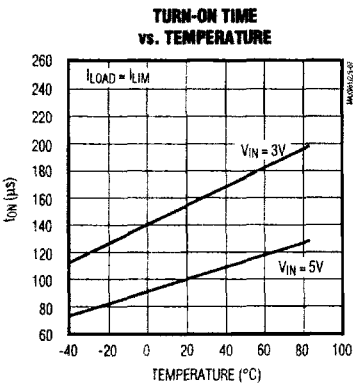
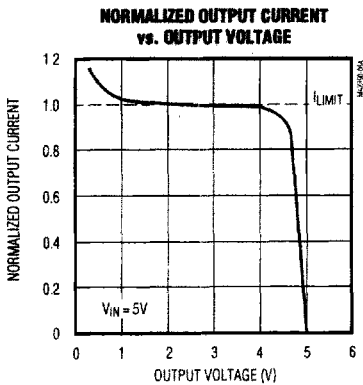
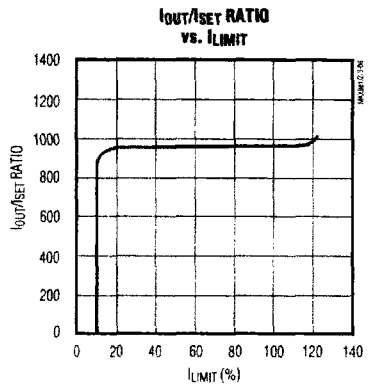
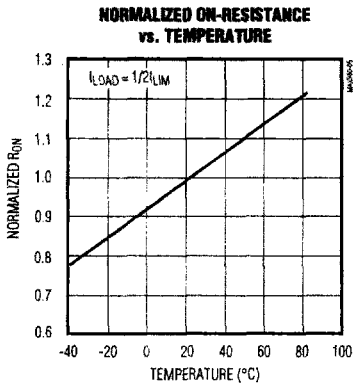
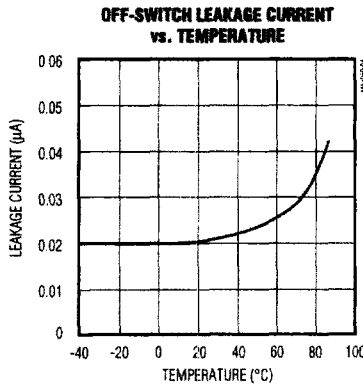
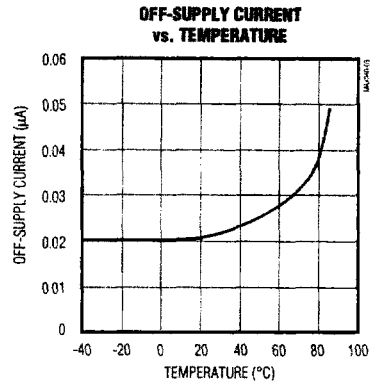
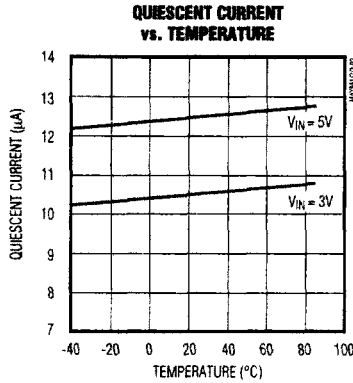
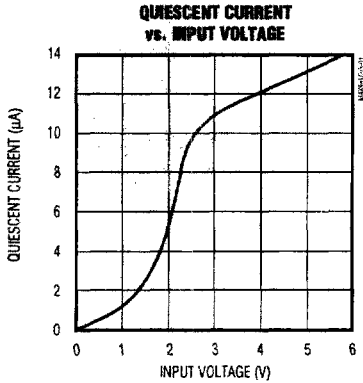

# Current-Limited, High-Side P-Channel Switches with Thermal Shutdown

## Typical Operating Characteristics (continued)

(Typical Operating Circuit,  $T_A = +25^\circ\text{C}$ , unless otherwise noted.)

**CURRENT-LIMIT RESPONSE**  
(MAX891L,  $R_L = 0.8\Omega$ )

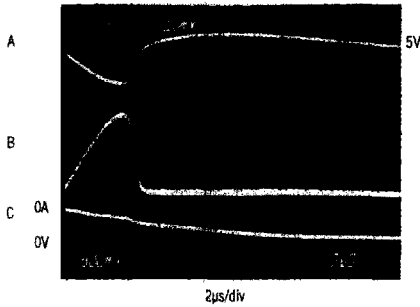

$C_{IN} = 47\mu\text{F}$ ,  $C_{OUT} = 0.1\mu\text{F}$   
A:  $V_{IN}$ , 500mV/div, AC COUPLED  
B:  $I_{OUT}$ , 2A/div  
C:  $V_{OUT}$ , 5V/div

**CURRENT-LIMIT RESPONSE**  
(MAX891L,  $R_L = 0.5\Omega$ )

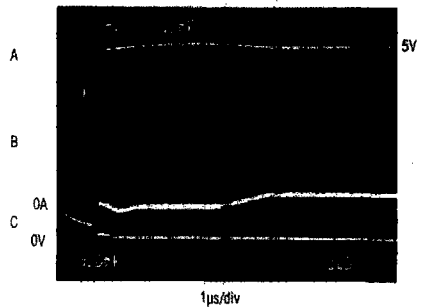

$C_{IN} = 47\mu\text{F}$ ,  $C_{OUT} = 0.1\mu\text{F}$   
A:  $V_{IN}$ , 500mV/div, AC COUPLED  
B:  $I_{OUT}$ , 2A/div  
C:  $V_{OUT}$ , 5V/div

**SWITCH TURN-ON TIME**

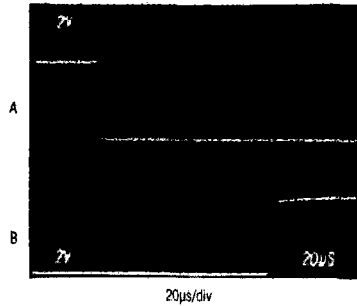

$V_{IN} = 5\text{V}$ ,  $I_{OUT} = I_{LIM}$   
A:  $V_{IN}$ , 2V/div  
B:  $V_{OUT}$ , 2V/div

**SWITCH TURN-OFF TIME**

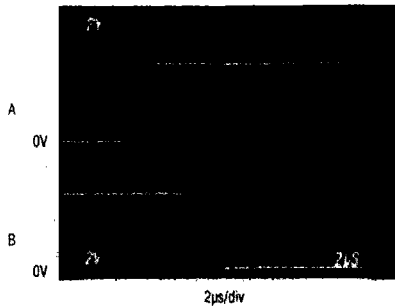

$V_{IN} = 5\text{V}$ ,  $I_{OUT} = I_{LIM}$   
A:  $V_{IN}$ , 2V/div  
B:  $V_{OUT}$ , 2V/div

**SWITCH TIMING CHARACTERISTICS**

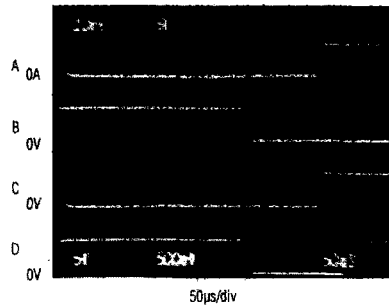

$V_{IN} = 5\text{V}$   
A:  $I_{LOAD}$ , 0.1A/div  
B:  $V_{IN}$ , 5V/div  
C:  $V_{OUT}$ , 5V/div  
D:  $V_{FAULT}$ , 5V/div

MAX891L/MAX892L

4

# Current-Limited, High-Side P-Channel Switches with Thermal Shutdown

## Pin Description

PIN	NAME	FUNCTION
1, 2	IN	Input, P-channel MOSFET source. Bypass IN with a 1 $\mu$ F capacitor to ground.
3	ON	Active-Low Switch On Input. A logic low turns the switch on.
4	GND	Ground
5	SET	Set Current-Limit Input. A resistor from SET to ground sets the current limit for the switch. See <i>Setting the Current Limit</i> section.
6	FAULT	Fault-Indicator Output. This open-drain output goes low when in current limit or when the die temperature exceeds +135°C.
7, 8	OUT	Switch Output. P-channel MOSFET drain. Bypass OUT with a 0.1 $\mu$ F capacitor to ground.

## Detailed Description

The MAX891L/MAX892L P-channel MOSFET power switches limit output current to a user-programmed level. When the output current is increased beyond the set current level, the current is also increased through the replica switch (I<sub>OUT</sub>/965) and through R<sub>SET</sub> (Figure 1). The current-limit error amplifier compares the voltage across R<sub>SET</sub> to the internal 1.24V reference and regulates the current back to the lesser of the programmed current limit (I<sub>LIMIT</sub>) or the maximum current limit (I<sub>MAX</sub>).

These switches are not bidirectional; therefore, the input voltage must be higher than the output voltage.

### Setting the Current Limit

The MAX891L/MAX892L feature internal current-limiting circuitry with maximum programmable values (I<sub>MAX</sub>) of 500mA and 250mA, respectively. For best performance, set the current limit (I<sub>LIMIT</sub>) between  $0.2I_{MAX} \leq I_{LIMIT} \leq I_{MAX}$ . This current limit remains in effect throughout the input supply-voltage range.

Program the current limit with a resistor (R<sub>SET</sub>) from SET to ground (Figure 2) as follows:

$$I_{SET} = I_{LIMIT} / I_{RATIO}$$

$$R_{SET} = 1.240 / I_{SET}$$

where I<sub>LIMIT</sub> is the desired current limit, and I<sub>RATIO</sub> is the I<sub>OUT</sub> to I<sub>SET</sub> current ratio (965).

### Short-Circuit Protection

The MAX891L/MAX892L are short-circuit-protected switches. In the event of an output short circuit or current-overload condition, the current through the switch is limited by the internal current-limiting error amplifier to  $1.5 \times I_{LIMIT}$ . When the fault condition is removed, the replica error amplifier sets the current limit back to I<sub>LIMIT</sub>.

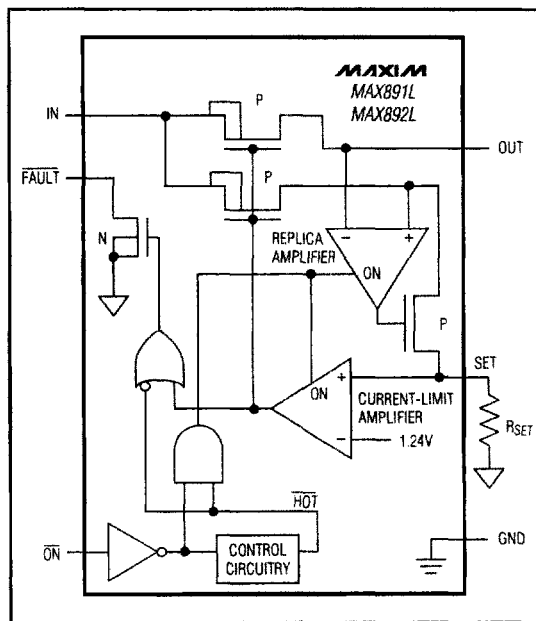

Figure 1. Functional Diagram

For a high  $\Delta V_{DS}/\Delta t$  during an output short-circuit condition, the switch turns off and disconnects the input supply from the output. The current-limiting amplifier then slowly turns the switch on with the output current limited to  $1.5 \times I_{LIMIT}$ . When the fault condition is removed, the current limit is set back to I<sub>LIMIT</sub>. Refer to the Current-Limit Response graphs in the *Typical Operating Characteristics*.

# Current-Limited, High-Side P-Channel Switches with Thermal Shutdown

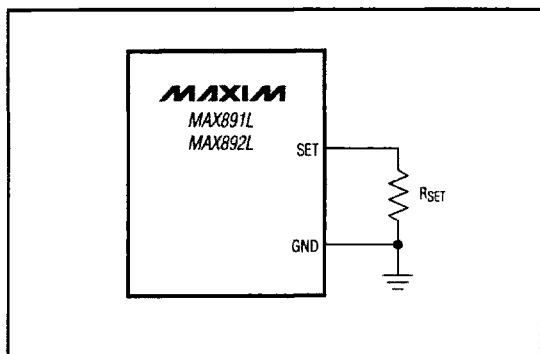

Figure 2. Setting the Current Limit

## Thermal Shutdown

The MAX891L/MAX892L feature thermal shutdown. The switch turns off when the junction temperature exceeds +135°C. Once the device cools by 10°C, the switch turns back on. If the fault short-circuit condition is not removed, the switch will cycle on and off, resulting in a pulsed output.

## Fault Indicator

The MAX891L/MAX892L provide a fault output ( $\overline{\text{FAULT}}$ ). This open-drain output goes low when in current limit or when the die temperature exceeds +135°C. During start-up,  $\overline{\text{FAULT}}$  is low until the switch is fully on and no over-current condition exists. A 100k $\Omega$  pull-up resistor from  $\overline{\text{FAULT}}$  to IN provides a logic-control signal.

## Applications Information

### Input Capacitor

To limit input voltage drop during momentary output short-circuit conditions, connect a capacitor from IN to GND. A 1 $\mu\text{F}$  ceramic capacitor is adequate for most applications; however, higher capacitor values further reduce voltage drop at the input.

### Output Capacitor

Connect a 0.1 $\mu\text{F}$  capacitor from OUT to GND. One function of this capacitor is to prevent inductive parasitics from pulling OUT negative during turn-off.

### Layout and Thermal-Dissipation Consideration

To take full advantage of the switch-response time to output short-circuit conditions, it is very important to keep all traces as short as possible to reduce the effect of undesirable parasitic inductance. Place input and output capacitors as close as possible to the device (no more than 5mm).

Under normal operating conditions, the package dissipates and channels heat away. Calculate maximum power as follows:

$$P = I_{\text{LIM}}^2 \times R_{\text{ON}}$$

where  $R_{\text{ON}}$  is the on-resistance of the switch.

When the output is short circuited, voltage drop across the switch equals the input supply. Hence, the power dissipated across the switch increases, as does the die temperature. If the fault condition is not removed, the thermal-overload-protection circuitry turns the switch off until the die temperature falls by 10°C. A ground plane in contact with the device helps dissipate additional heat.

## Chip Information

TRANSISTOR COUNT: 396

SUBSTRATE CONNECTED TO GND

# Current-Limited, High-Side P-Channel Switches with Thermal Shutdown

MAX891L/MAX892L

## Tape-and-Reel Information

