



- Low Loss SAW Filter
- Surface Mount 3.0 x 3.0 mm Package
- Complies with Directive 2002/95/EC (RoHS) 

#### Absolute Maximum Ratings

Rating	Value	Units
Input Power Level	5	dBm
DC Voltage on any Non-ground Terminal	3	V
Operating Temperature Range	-40 to +85	°C
Storage Temperature Range in Tape and Reel	-40 to +90	°C
Maximum Soldering Profile, 5 cycles/10 seconds maximum	265	°C

**SF2133E**

**1747.50 MHz  
SAW Filter**

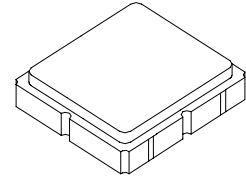

**SM3030-6**

#### Electrical Characteristics

Characteristic	Sym	Notes	Min	Typ	Max	Max	Units
					-20 to +70 °C	-40 to +85 °C	
Center Frequency	$f_c$			1747.5			MHz
Insertion Loss, 1710 to 1785 MHz	IL			2.6	4.0	4.1	dB
Amplitude Ripple, 1710 to 1785 MHz				1.6	2.5	2.8	dB <sub>P-P</sub>
Attenuation Referenced to 0 dB:							
10 to 1670 MHz			15	23			dB
1670 to 1690 MHz			6	23.9			
1805 to 1880 MHz			6	24			
1880 to 4500 MHz			15	25			
4500 to 5000 MHz			10	14			
Input/Output VSWR, 1710 to 1785 MHz				1.8:1	2.5:1	2.5:1	
Source Impedance	$Z_S$			50			$\Omega$
Load Impedance	$Z_L$			50			$\Omega$
Case Style	SM3030-6 3.0 x 3.0 mm Nominal Footprint						
Lid Symbolization (Y=year, WW=week, S=shift) dot=pin 1 indicator	679, YWWS						
Standard Reel Quantity	Reel Size 7 Inch	500 Pieces/Reel					
	Reel Size 13 Inch	3000 Pieces/Reel					

#### Electrical Connections

Connection	Terminals
Input	2
Output	5
Case Ground	All others



**CAUTION: Electrostatic Sensitive Device. Observe precautions for handling.**

#### Notes:

1. Unless noted otherwise, all specifications apply over the operating temperature range with filter soldered to the specified demonstration board with impedance matching to 50  $\Omega$  and measured with 50  $\Omega$  network analyzer.
2. Unless noted otherwise, all frequency specifications are referenced to the nominal center frequency,  $f_c$ .
3. Rejection is measured as attenuation below the minimum IL point in the passband. Rejection in final user application is dependent on PCB layout and external impedance matching design. See Application Note No. 42 for details.
4. "LRIP" or "L" after the part number indicates "low rate initial production" and "ENG" or "E" indicates "engineering prototypes."
5. The design, manufacturing process, and specifications of this filter are subject to change.
6. Either Port 1 or Port 2 may be used for either input or output in the design. However, impedances and impedance matching may vary between Port 1 and Port 2, so that the filter must always be installed in one direction per the circuit design.
7. US and international patents may apply.
8. RFM, stylized RFM logo, and RF Monolithics, Inc. are registered trademarks of RF Monolithics, Inc.

F. Frequency Characteristics :  
Transfer function

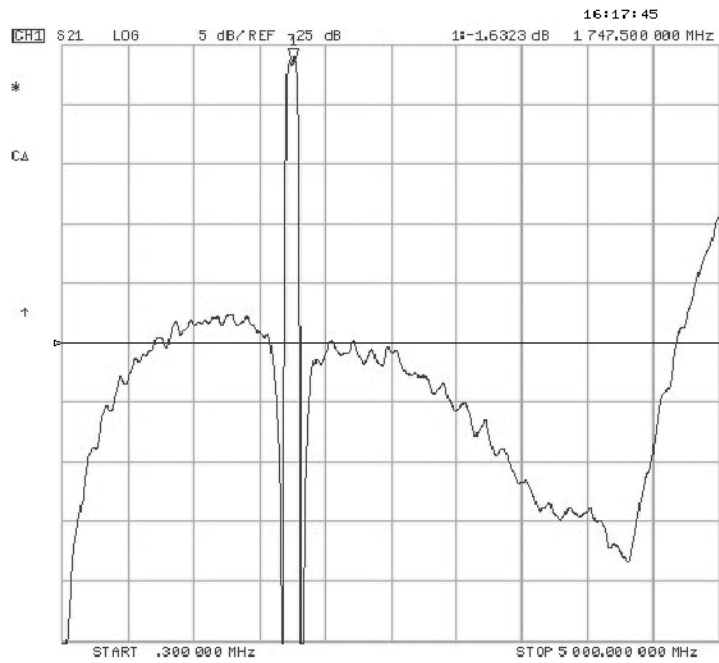
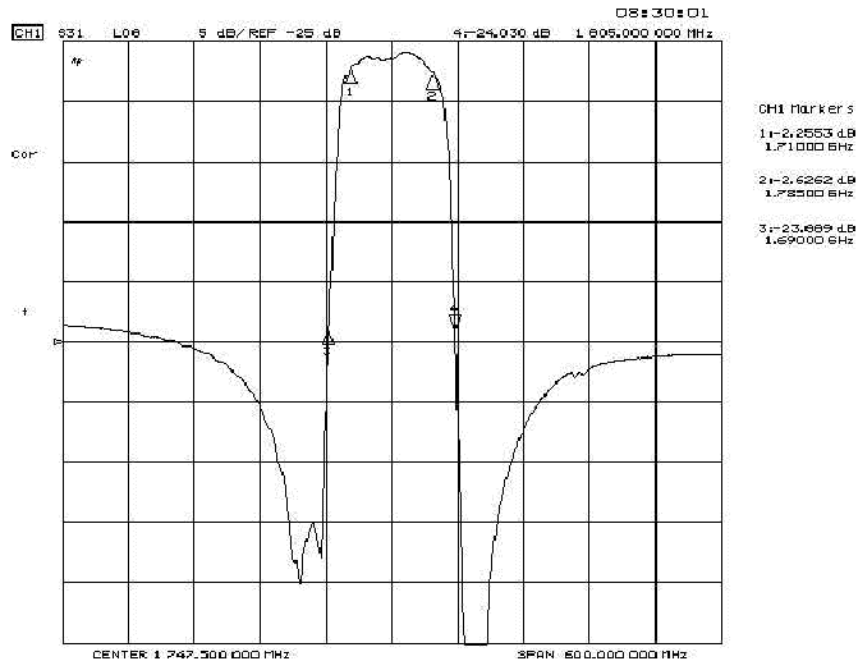

# Reflections Functions :

## S11

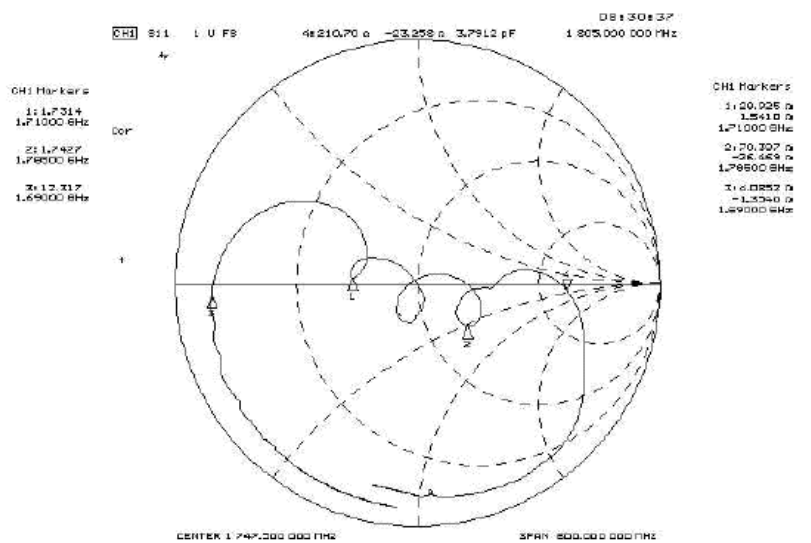
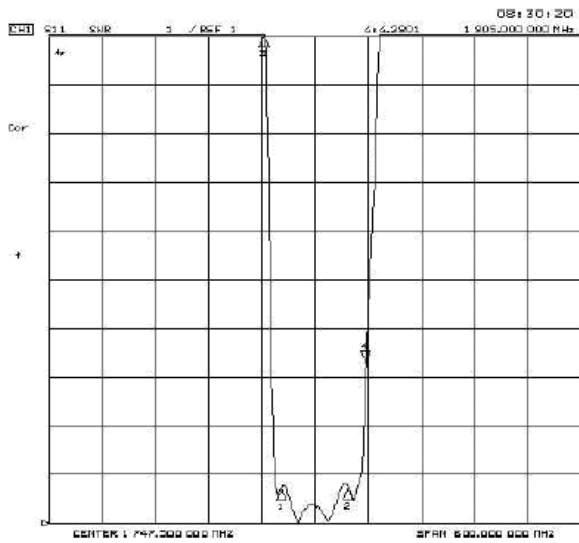

## S22

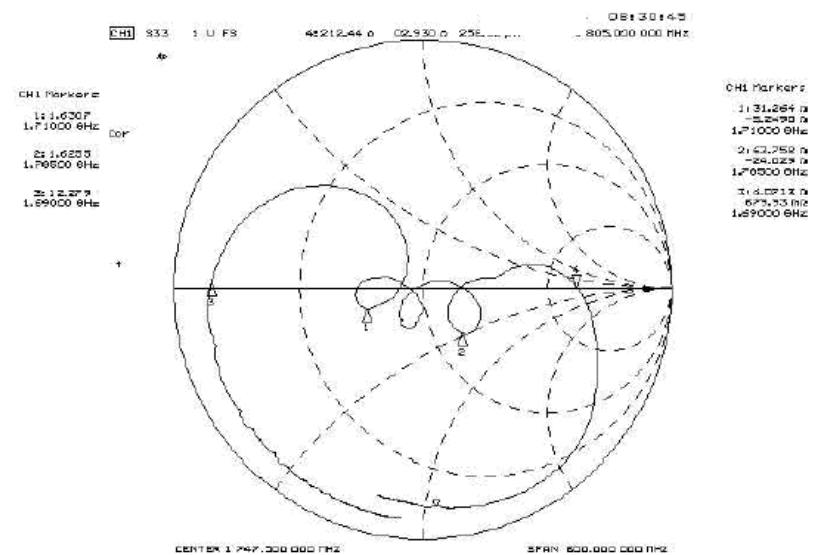
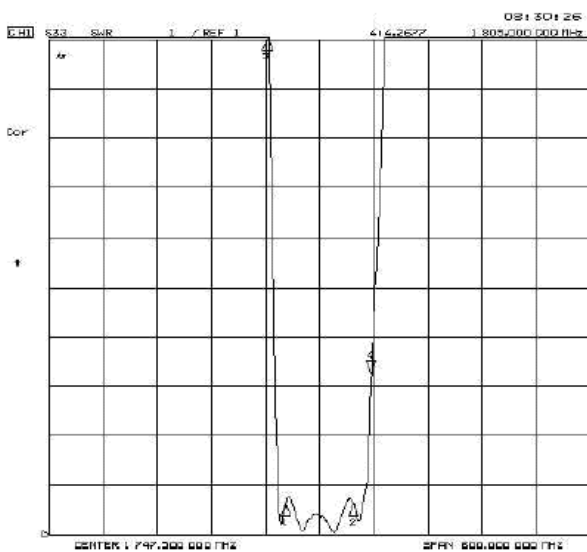

# SM3030-6 Case

## 6-Terminal Ceramic Surface-Mount Case

### 3.0 X 3.0 mm Nominal Footprint

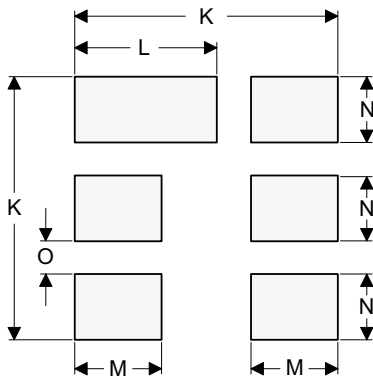
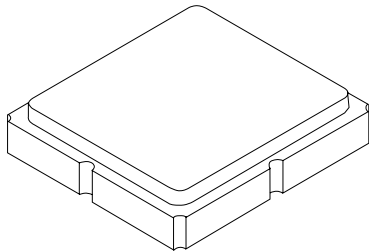

PCB Footprint Top View

#### Case and PCB Footprint Dimensions

Dimension	mm			Inches		
	Min	Nom	Max	Min	Nom	Max
A	2.87	3.00	3.13	0.113	0.118	0.123
B	2.87	3.00	3.13	0.113	0.118	0.123
C	1.12	1.25	1.38	0.044	0.049	0.054
D	0.77	0.90	1.03	0.030	0.035	0.040
E	2.67	2.80	2.93	0.105	0.110	0.115
F	1.47	1.60	1.73	0.058	0.063	0.068
G	0.72	0.85	0.98	0.028	0.033	0.038
H	1.37	1.50	1.63	0.054	0.059	0.064
I	0.47	0.60	0.73	0.019	0.024	0.029
J	1.17	1.30	1.43	0.046	0.051	0.056
K		3.20			0.126	
L		1.70			0.067	
M		1.05			0.041	
N		0.81			0.032	
O		0.38			0.015	

#### Case Materials

Materials	
Solder Pad Plating	0.3 to 1.0 $\mu$ m Gold over 1.27 to 8.89 $\mu$ m Nickel
Lid Plating	2.0 to 3.0 $\mu$ m Nickel
Body	Al <sub>2</sub> O <sub>3</sub> Ceramic
Pb Free	

#### Top View

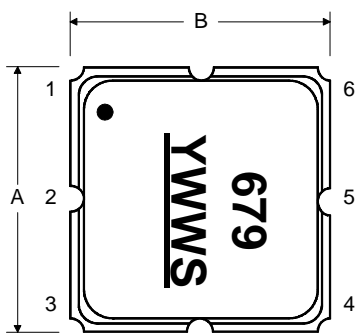

#### Bottom View

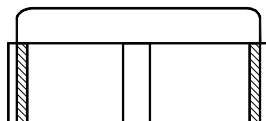
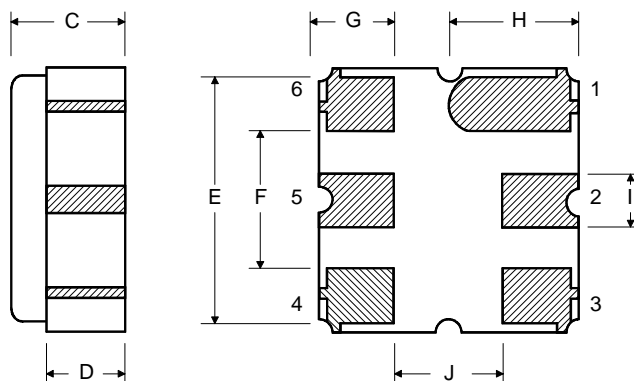

## Tape and Reel Specifications

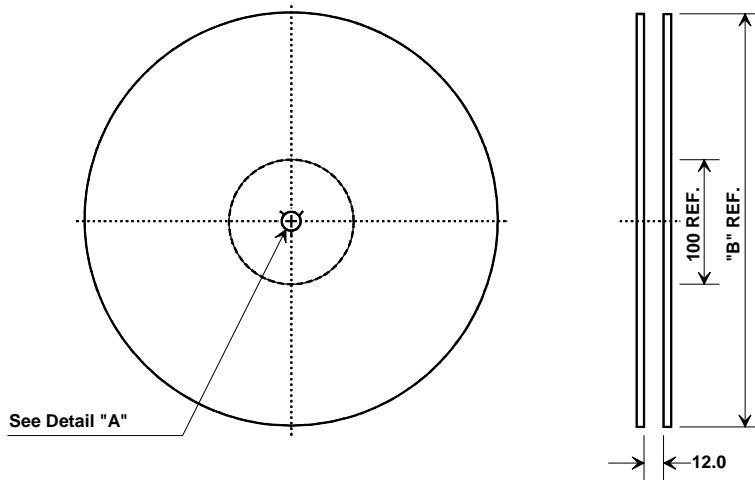

"B"		Quantity Per Reel
Inches	millimeters	
7	178	500
13	330	3000

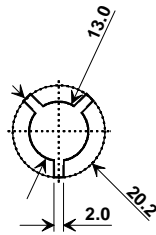

## COMPONENT ORIENTATION and DIMENSIONS

Carrier Tape Dimensions	
Ao	3.35 mm
Bo	3.35 mm
Ko	1.40 mm
Pitch	8.0 mm
W	12.0 mm

