

Powered by



XTV1272

▶ 12V 7.2Ah

XTV 1272 is a general battery up to 12 years expected life in standby service or more than 260 cycles at 100% discharge in cycle service . XTV has a wider operating temperature range, which makes them more suitable for the systems in harsh conditions.



► Specification

Cells Per Unit	6
Voltage Per Unit	12
Capacity	7.2Ah @ 10hr-rate to 1.80V per cell @25 °C(77°F)
Weight	Approx. 2.75 kg(6.06 lbs)
Maximum Discharge Current	130A(5sec)
Internal Resistance	Approx. 21mΩ
Operating Temperature Range	Discharge: -20°C~50°C (-4°F~122°F) Charge: -20°C~50°C (-4°F~122°F) Storage: -20°C~50°C (-4°F~122°F)
Nominal Operating Temperature Range	25°C±3°C(77°F±5°F)
Float Charging Voltage	13.5 to 13.8 VDC/unit Average at 25°C(77°F)
Recommended Maximum Charging Current Limit	2.16A
Equalization and Cycle Service	14.4 to 15.0 VDC/unit Average at 25°C(77°F)
Self Discharge	CSB Batteries can be stored for more than 6 months at 25°C(77°F). Please charge batteries before using . For higher temperatures the time interval will be shorter.
Terminal	F2-Faston Tab 250
Container Material	ABS(UL 94-HB/File E50263)*Flammability resistance of (UL 94-V0/File E88637) can be available upon request.



CSB-manufactured VRLA batteries are UL-recognized components under UL924 and UL1989.

CSB is also certified by ISO 9001 and ISO 14001.

► Dimensions :

Unit: mm (inch)

Overall Height (H)	Container height (h)	Length (L)	Width (W)
100±1 (3.81±0.04)	97±1 (3.7±0.04)	151±2.0 (5.94±0.08)	65±1.0 (2.56±0.04)

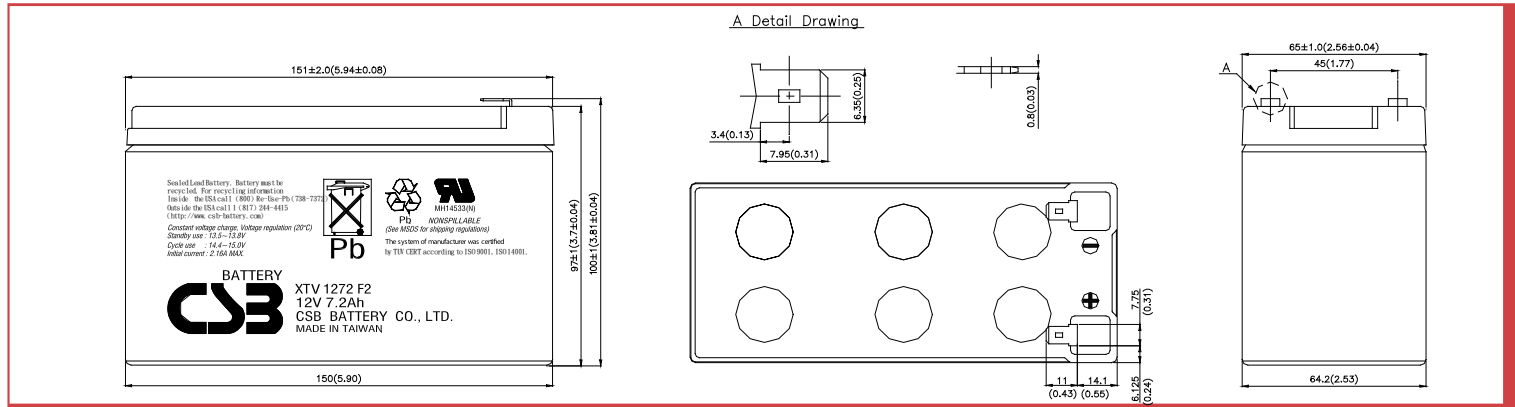

Constant Current Discharge Characteristics Unit:A (25°C ,77°F)

F.V/Time	5MIN	10MIN	15MIN	30MIN	1HR	2HR	3HR	4HR	5HR	8HR	10HR	20HR
1.60V	27.7	17.7	13.4	7.94	4.61	2.68	1.93	1.53	1.26	0.888	0.712	0.389
1.67V	26.8	17.4	13.3	7.87	4.48	2.63	1.90	1.50	1.25	0.877	0.708	0.385
1.70V	25.8	17.1	13.2	7.82	4.41	2.62	1.89	1.49	1.24	0.868	0.703	0.380
1.75V	24.6	16.4	12.9	7.75	4.31	2.60	1.88	1.48	1.23	0.847	0.698	0.375
1.80V	21.8	15.4	12.3	7.53	4.23	2.57	1.86	1.47	1.22	0.828	0.689	0.371
1.85V	18.3	13.9	11.2	7.10	4.11	2.48	1.80	1.42	1.19	0.802	0.670	0.366

Constant Power Discharge Characteristics Unit:W (25°C ,77°F)

F.V/Time	5MIN	10MIN	15MIN	30MIN	1HR	2HR	3HR	4HR	5HR	8HR	10HR	20HR
1.60V	299	193	149	89.8	54.8	32.1	23.1	18.3	15.2	10.3	8.65	4.68
1.67V	290	190	148	89.3	54.7	31.9	23.0	18.2	15.1	10.2	8.63	4.63
1.70V	282	188	147	88.8	54.5	31.8	22.9	18.1	15.0	10.1	8.60	4.60
1.75V	264	182	145	88.1	53.8	31.7	22.8	18.0	14.9	10.0	8.55	4.56
1.80V	239	173	138	86.3	53.2	31.4	22.7	17.8	14.8	9.93	8.50	4.51
1.85V	206	160	128	82.3	51.8	30.2	21.9	17.5	14.7	9.85	8.27	4.45

Ratings are preliminary and subject to change.

Trickle (or Float) Service Life

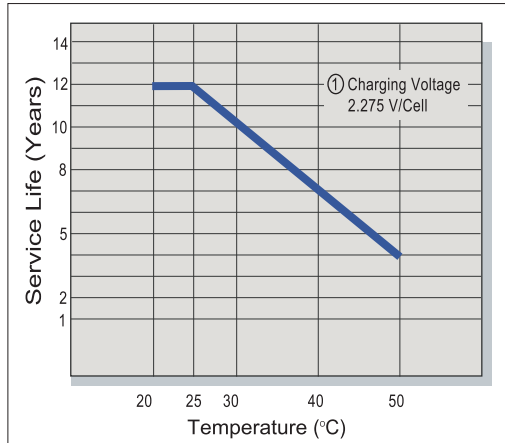

Capacity Retention Characteristic

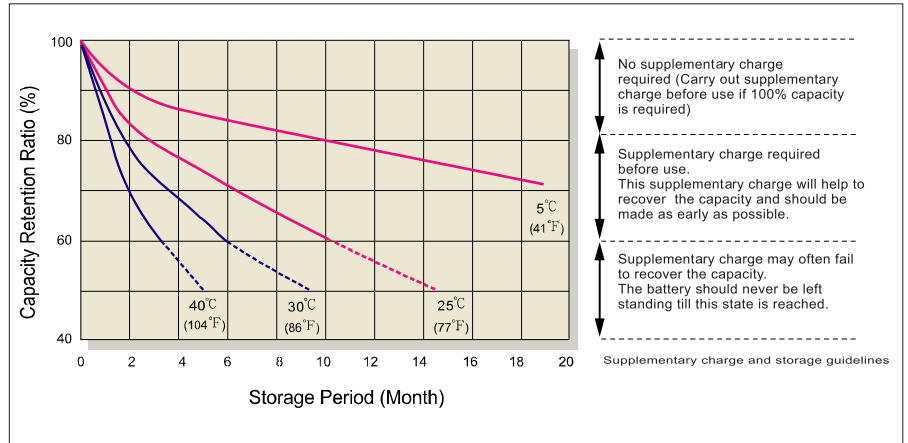

Supplementary charge and storage guidelines

- No supplementary charge required (Carry out supplementary charge before use if 100% capacity is required)
- Supplementary charge required before use. This supplementary charge will help to recover the capacity and should be made as early as possible.
- Supplementary charge may often fail to recover the capacity. The battery should never be left standing till this state is reached.

Battery Voltage and Charge Time for Standby Use

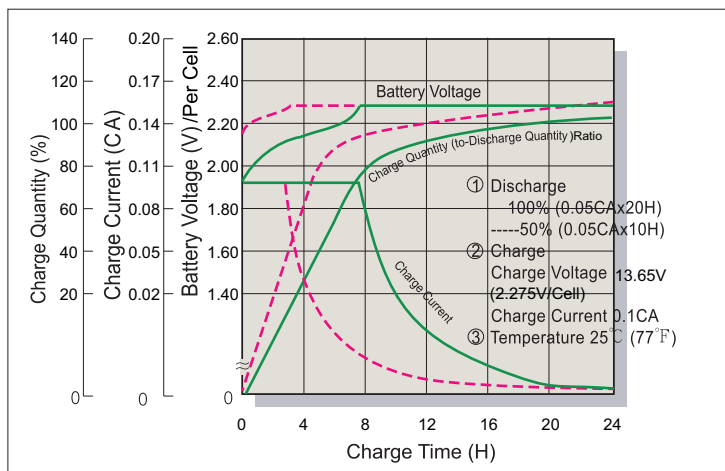

Cycle Service Life

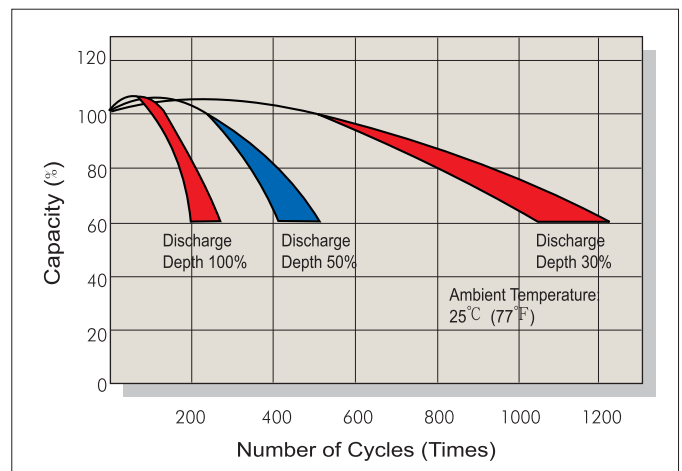

Battery Voltage and Charge Time for Cycle Use

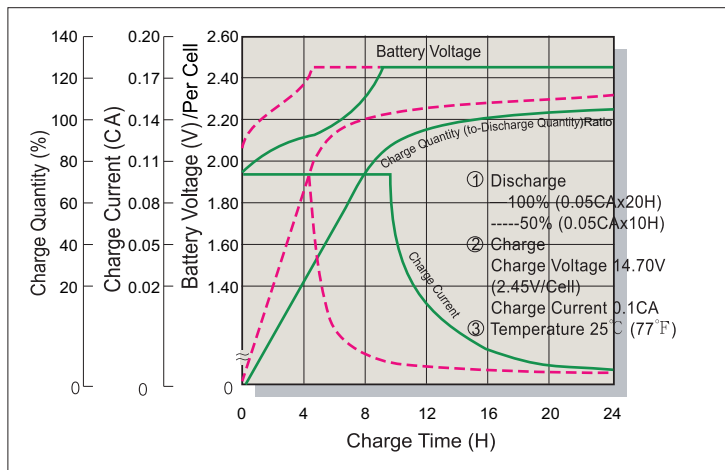

Terminal Voltage (V) and Discharge Time

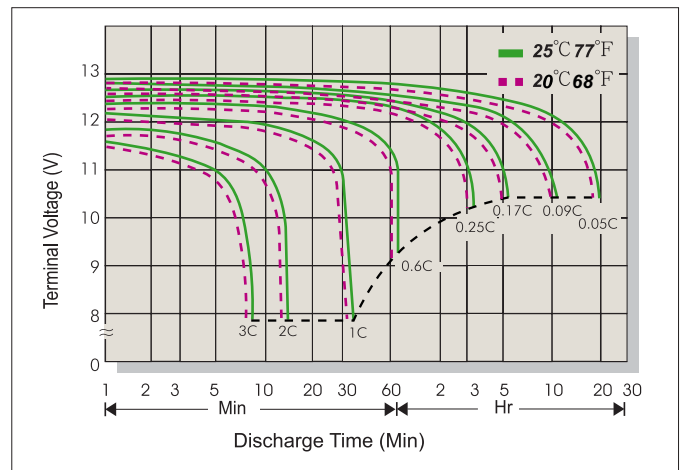

Charging Procedures

Application	Charge Voltage(V/Cell)			Max.Charge Current
	Temperature	Set Point	Allowable Range	
Cycle Use	25°C(77°F)	2.45	2.40~2.50	0.3C
Standby	25°C(77°F)	2.275	2.25~2.30	

Discharge Current VS. Discharge Voltage

Final Discharge Voltage V/Cell	1.75	1.70	1.60	1.30
Discharge Current(A)	0.2C>(A)	0.2C<(A)<0.5C	0.5C<(A)<1.0C	(A)>1.0C

Sales Office URL: WWW.CSB-BATTERY.COM

GLOBAL HQ
CSB BATTERY CO., LTD. (TAIWAN)
 Tel : +886-2-2555-5600
 Fax : +886-2-2555-3300
 mail : service@csb-battery.com.tw

BEIJING OFFICE. (CHINA)
CSB BATTERY TECHNOLOGIES (BEIJING) CO., LTD.
 Tel : +86-10-59621300/1301/1302/1303
 Fax : +86-10-59621304
 mail : chinasl@csb-battery.com

AMERICA HQ
CSB BATTERY TECHNOLOGIES INC. (U.S.A)
 Tel : +1-817-244-7777/1-(800)3-CSB-USA(272872)
 Fax : +1-817-244-4445
 mail : csb@csb-battery.com

SHANGHAI OFFICE. (CHINA)
CSB BATTERY LOGISTIC (SHANGHAI) CO., LTD.
 Tel : +86-21-5046-1622/5046-0833
 Fax : +86-21-5064-3314
 mail : chinasl@csb-battery.com

EUROPE HQ
CSB Battery Europe BV.
 Tel : +31(0)-180-418-140
 Fax : +886-2-2555-3300
 mail : eurosales@csb-battery.eu

SHENZHEN OFFICE. (CHINA)
CSB BATTERY LOGISTIC (SHANGHAI) CO., LTD.
 Tel : +86-755-8831-6488/6396/6356
 Fax : +86-755-8831-6548
 mail : she@csb-battery.com.cn