

Features

- 200V/60A,
 $R_{DS(ON)} = 36m\Omega$ (Type) @ $V_{GS} = 10V$
- Low Gate Charge
- Fast Switching
- 100% avalanche tested
- 175°C Operating Temperature
- Lead Free, RoHS compliant

Applications

- Switching Application

Pin Description

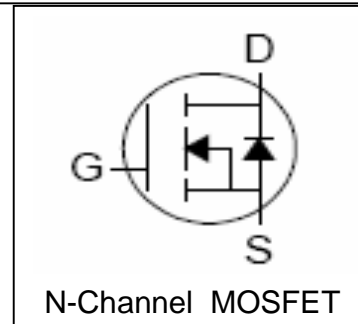
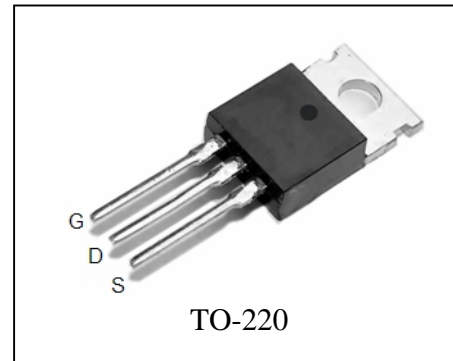

Absolute Maximum Ratings

Symbol	Parameter	Rating	Unit
Common Ratings ($T_A = 25^\circ C$ Unless Otherwise Noted)			
V_{DSS}	Drain-Source Voltage	200	V
V_{GSS}	Gate-Source Voltage	± 25	
T_J	Maximum Junction Temperature	175	$^\circ C$
T_{STG}	Storage Temperature Range	-55 to 175	$^\circ C$
I_S	Diode Continuous Forward Current	$T_C = 25^\circ C$ 60	A
Mounted on Large Heat Sink			
I_{DP}	300 μs Pulse Drain Current Tested	$T_C = 25^\circ C$ 230 ^①	A
I_D	Continuous Drain Current	$T_C = 25^\circ C$ 60 ^②	A
		$T_C = 100^\circ C$ 45 ^②	
P_D	Maximum Power Dissipation	$T_C = 25^\circ C$ 312	W
		$T_C = 100^\circ C$ 156	
$R_{\theta JC}$	Thermal Resistance-Junction to Case	0.48	$^\circ C/W$
Drain-Source Avalanche Ratings			
E_{AS} ^③	Avalanche Energy, Single Pulsed	140	mJ

Electrical Characteristics ($T_A=25^\circ\text{C}$ Unless Otherwise Noted)

Symbol	Parameter	Test Condition	RU2H50R			Unit
			Min.	Typ.	Max.	
Static Characteristics						
BV_{DSS}	Drain-Source Breakdown Voltage	$V_{GS}=0V, I_{DS}=250\mu A$	200			V
I_{DSS}	Zero Gate Voltage Drain Current	$V_{DS}=200V, V_{GS}=0V$ $T_J=85^\circ\text{C}$			1	μA
					30	
$V_{GS(th)}$	Gate Threshold Voltage	$V_{DS}=V_{GS}, I_{DS}=250\mu A$	2	3	4	V
I_{GSS}	Gate Leakage Current	$V_{GS}=\pm 25V, V_{DS}=0V$			± 100	nA
$R_{DS(ON)}^{(4)}$	Drain-Source On-state Resistance	$V_{GS}=10V, I_{DS}=28A$		36	43	m Ω
Diode Characteristics						
$V_{SD}^{(4)}$	Diode Forward Voltage	$I_{SD}=28A, V_{GS}=0V$			1.2	V
t_{rr}	Reverse Recovery Time	$I_{SD}=28A, di_{SD}/dt=100A/\mu s$		212		ns
Q_{rr}	Reverse Recovery Charge			980		nC
Dynamic Characteristics ⁽⁵⁾						
R_G	Gate Resistance	$V_{GS}=0V, V_{DS}=0V, F=1\text{MHz}$		3.8		Ω
C_{iss}	Input Capacitance	$V_{GS}=0V,$ $V_{DS}=50V,$ Frequency=1.0MHz		4550		pF
C_{oss}	Output Capacitance			620		
C_{rss}	Reverse Transfer Capacitance			155		
$t_{d(ON)}$	Turn-on Delay Time	$V_{DD}=100V, R_L=35\Omega,$ $I_{DS}=28A, V_{GEN}=10V,$ $R_G=6\Omega$		18		ns
t_r	Turn-on Rise Time			70		
$t_{d(OFF)}$	Turn-off Delay Time			56		
t_f	Turn-off Fall Time			45		
Gate Charge Characteristics ⁽⁵⁾						
Q_g	Total Gate Charge	$V_{DS}=160V, V_{GS}=10V,$ $I_{DS}=28A$		160	208	nC
Q_{gs}	Gate-Source Charge			29		
Q_{gd}	Gate-Drain Charge			70		

- Notes:
- ① Pulse width limited by safe operating area.
 - ② Calculated continuous current based on maximum allowable junction temperature. Current limited by bond wire.
 - ③ Limited by $T_{Jmax}, I_{AS}=20A, V_{DD}=60V, R_G=47\Omega$, Starting $T_J=25^\circ\text{C}$.
 - ④ Pulse test; Pulse width $\leq 300\mu s$, duty cycle $\leq 2\%$.
 - ⑤ Guaranteed by design, not subject to production testing.

Typical Characteristics

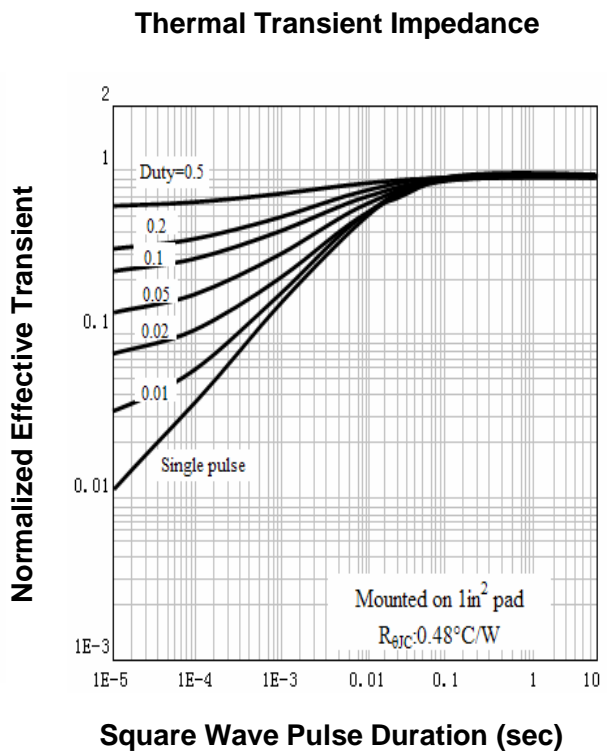
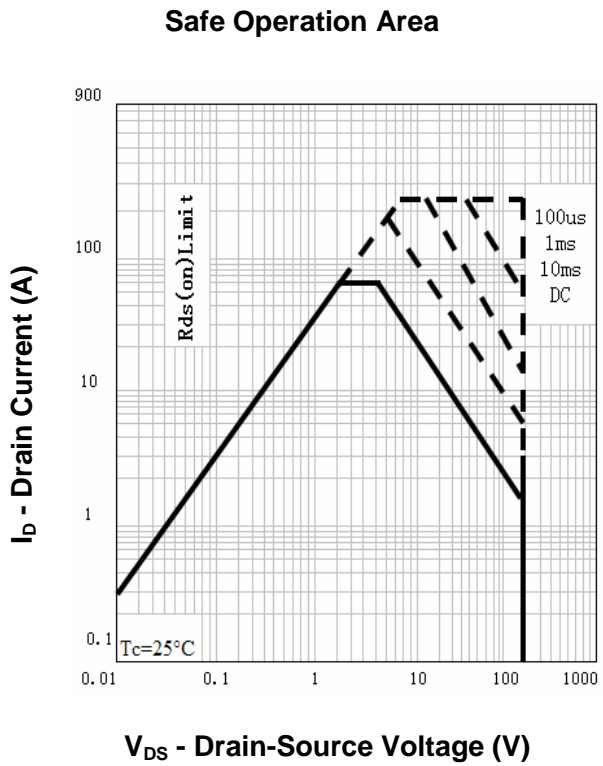
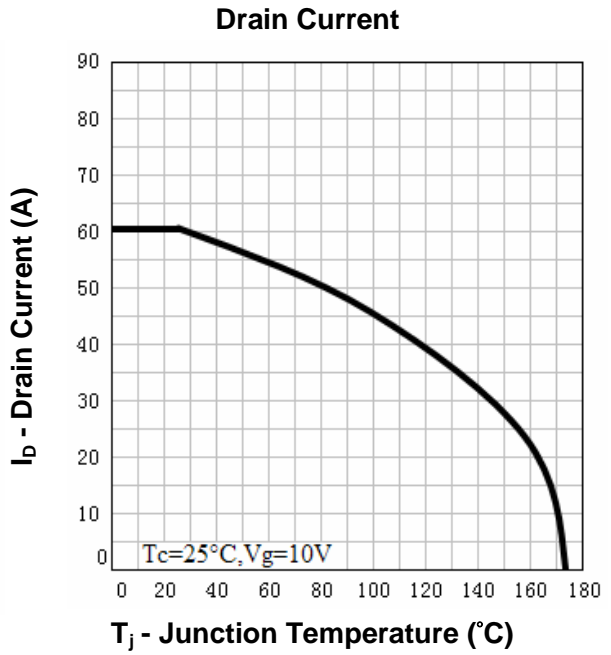
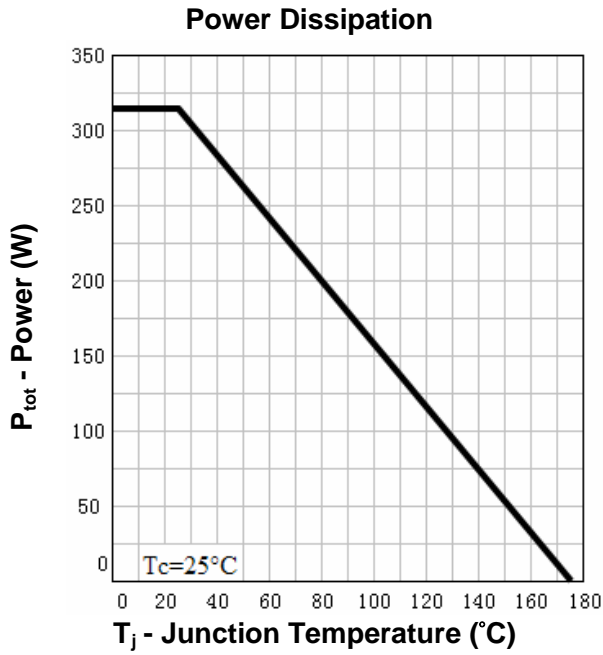

Typical Characteristics

Output Characteristics

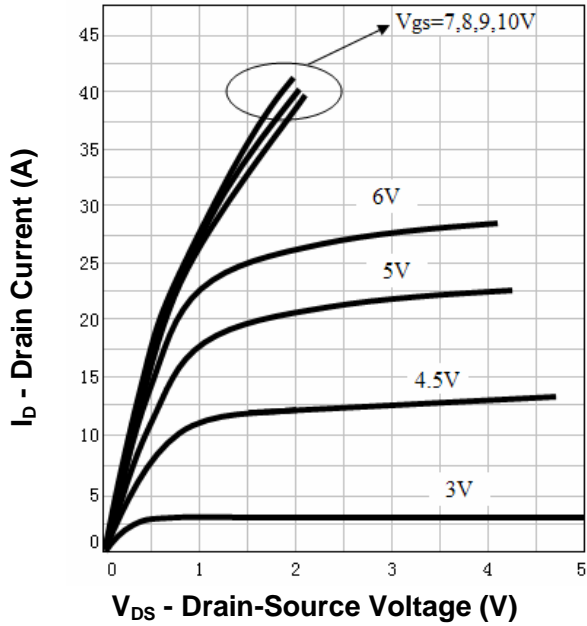

Drain-Source On Resistance

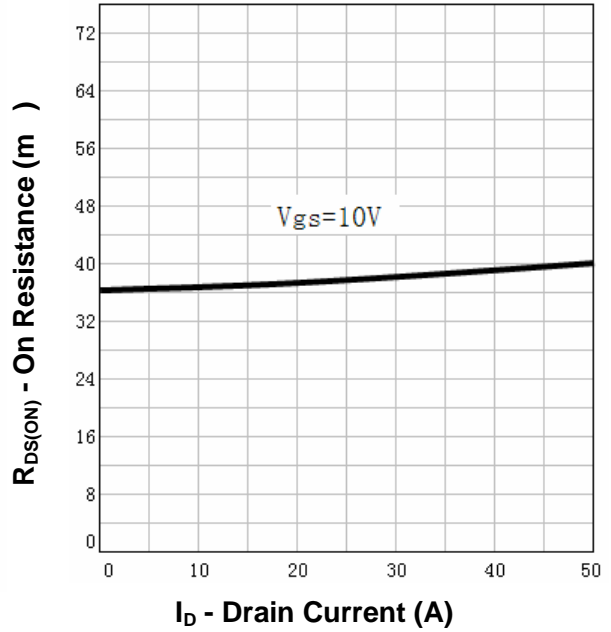

Drain-Source On Resistance

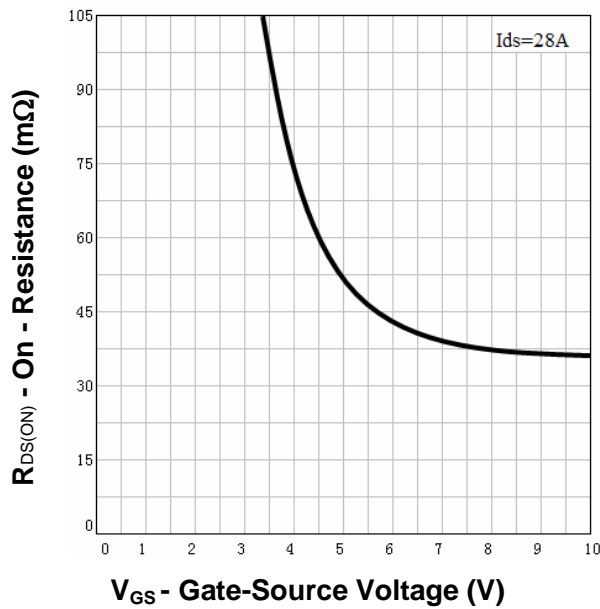

Gate Threshold Voltage

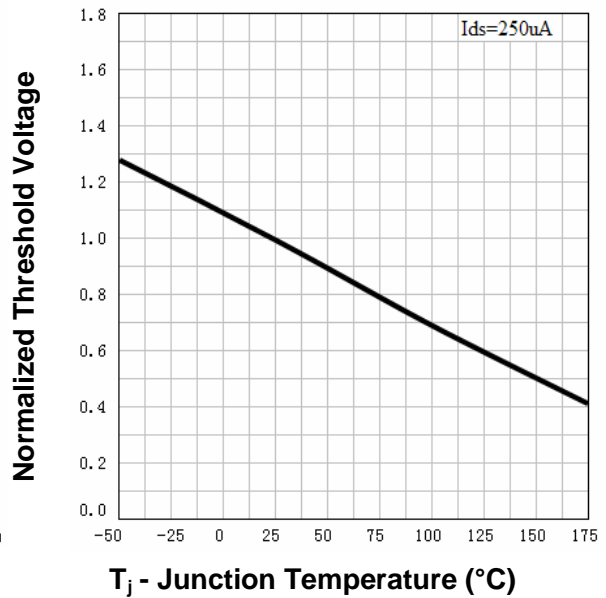

Typical Characteristics

Drain-Source On Resistance

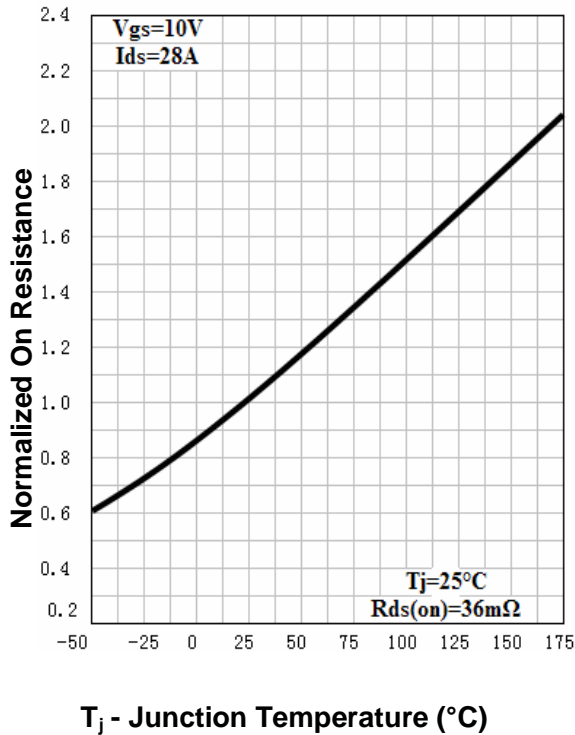

Source-Drain Diode Forward

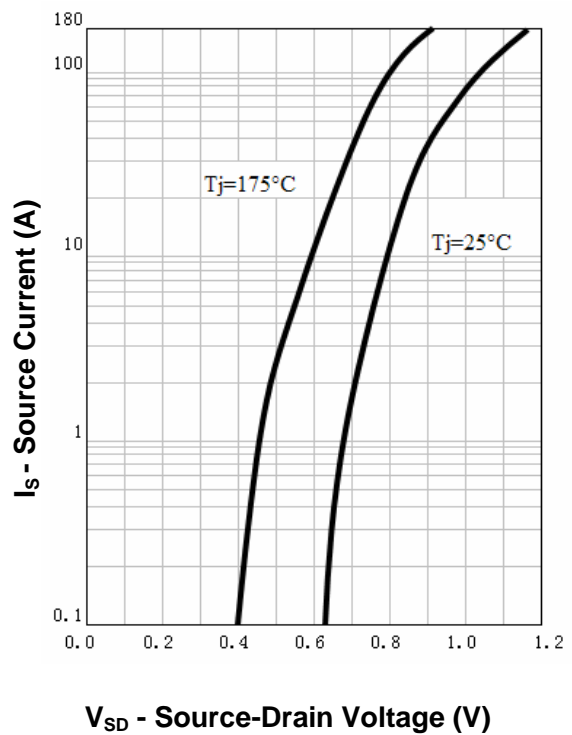

Capacitance

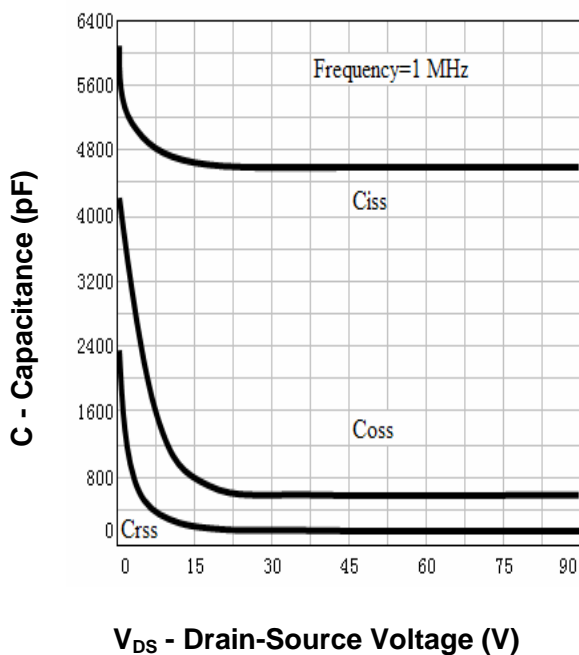

Gate Charge

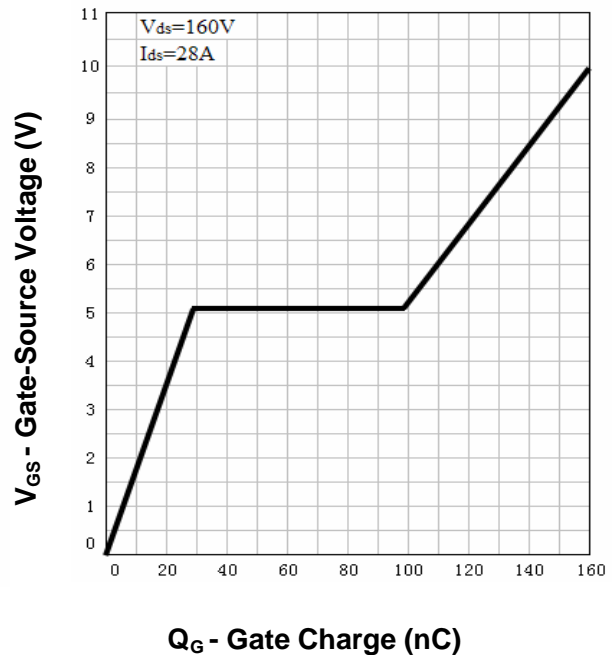

Avalanche Test Circuit and Waveforms

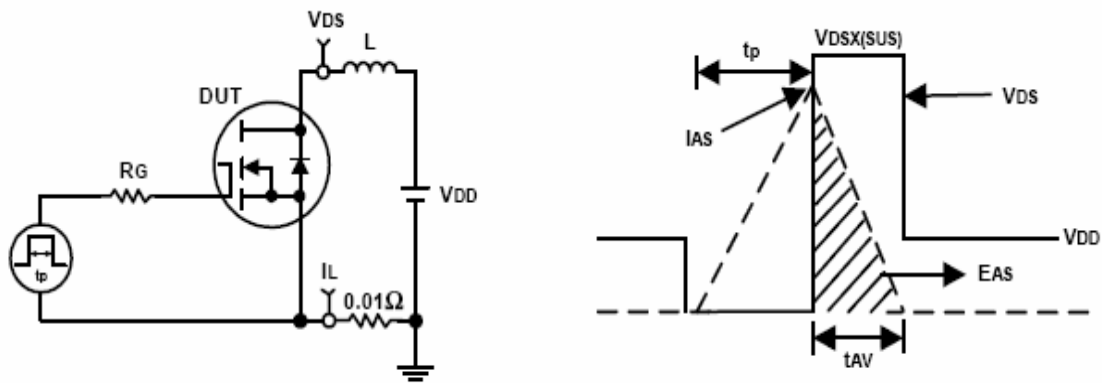

Switching Time Test Circuit and Waveforms

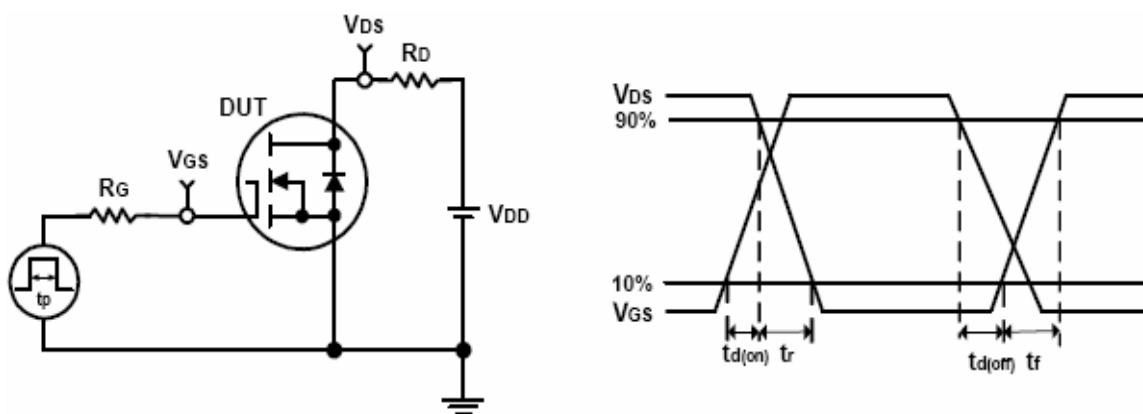

Ordering and Marking Information

Device	Marking	Package	Packaging	Quantity	Reel Size	Tape width
RU2H50R	RU2H50R	TO-220	Tube	50	-	-

Package Information
TO-220FB-3L

SYMBOL	MM			INCH			SYMBOL	MM			INCH		
	MIN	NOM	MAX	MIN	NOM	MAX		MIN	NOM	MAX	MIN	NOM	MAX
A	4.40	4.57	4.70	0.173	0.180	0.185	ϕ_{p1}	1.40	1.50	1.60	0.055	0.059	0.063
A1	1.27	1.30	1.33	0.050	0.051	0.052	e	2.54BSC			0.1BSC		
A2	2.35	2.40	2.50	0.093	0.094	0.098	e1	5.08BSC			0.2BSC		
b	0.77	-	0.90	0.030	-	0.035	H1	6.40	6.50	6.60	0.252	0.256	0.260
b2	1.23	-	1.36	0.048	-	0.054	L	12.75	-	13.17	0.502	-	0.519
C	0.48	0.50	0.52	0.019	0.020	0.021	L1	-	-	3.95	-	-	0.156
D	15.40	15.60	15.80	0.606	0.614	0.622	L2	2.50REF.			0.098REF.		
D1	9.00	9.10	9.20	0.354	0.358	0.362	ϕ_p	3.57	3.60	3.63	0.141	0.142	0.143
DEP	0.05	0.10	0.20	0.002	0.004	0.008	Q	2.73	2.80	2.87	0.107	0.110	0.113
E	9.70	9.90	10.10	0.382	0.389	0.398	θ_1	5°	7°	9°	5°	7°	9°
E1	-	8.70	-	-	0.343	-	θ_2	1°	3°	5°	1°	3°	5°
E2	9.80	10.00	10.20	0.386	0.394	0.401							

ALL DIMENSIONS REFER TO JEDEC STANDARD
DO NOT INCLUDE MOLD FLASH OR PROTRUSIONS

Customer Service

Worldwide Sales and Service:

Sales@ruichips.com

Technical Support:

Technical@ruichips.com

Investor Relations Contacts:

Investor@ruichips.com

Marcom Contact:

Marcom@ruichips.com

Editorial Contact:

Editorial@ruichips.com

HR Contact:

HR@ruichips.com

Legal Contact:

Legal@ruichips.com

Shen Zhen RUICHIPS Semiconductor CO., LTD

Room 501, the 5floor An Tong Industrial Building,
NO.207 Mei Hua Road Fu Tian Area Shen Zhen City, CHINA

TEL: (86-755) 8311-5334

FAX: (86-755) 8311-4278

E-mail: Sales-SZ@ruichips.com