

Ultrafast Recovery Rectifier

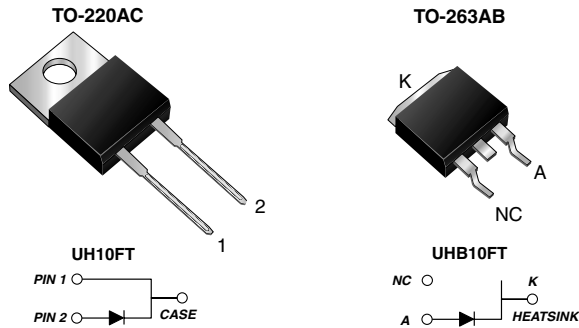

FEATURES

- Oxide planar chip junction
- Ultrafast recovery times
- Soft recovery characteristics
- Low switching losses, high efficiency
- High forward surge capability
- Meets MSL level 1, per J-STD-020, LF maximum peak of 245 °C (for TO-263AB package)
- Solder dip 260 °C, 40 s (for TO-220AC package)
- Component in accordance to RoHS 2002/95/EC and WEEE 2002/96/EC



RoHS
COMPLIANT

TYPICAL APPLICATIONS

For use in high frequency rectification and freewheeling application in switching mode converter and inverter for consumer.

MECHANICAL DATA

Case: TO-220AC and TO-263AB

Epoxy meets UL 94V-0 flammability rating

Terminals: Matte tin plated leads, solderable per J-STD-002 and JESD22-B102

E3 suffix for consumer grade, meets JESD 201 class 1A whisker test

Polarity: As marked

Mounting Torque: 10 in-lbs maximum

PRIMARY CHARACTERISTICS	
$I_{F(AV)}$	10 A
V_{RRM}	300 V
I_{FSM}	180 A
t_{rr}	25 ns
V_F	0.83 V
$T_J \text{ max.}$	175 °C

MAXIMUM RATINGS ($T_A = 25 \text{ °C}$ unless otherwise noted)				
PARAMETER	SYMBOL	UH10FT	UHB10FT	UNIT
Maximum repetitive peak reverse voltage	V_{RRM}	300		V
Maximum average forward rectified current (Fig. 1)	$I_{F(AV)}$	10		A
Peak forward surge current 10 ms single half sine-wave superimposed on rated load	I_{FSM}	180		A
Operating junction and storage temperature range	T_J, T_{STG}	- 55 to + 175		°C



ELECTRICAL CHARACTERISTICS (T _A = 25 °C unless otherwise noted)						
PARAMETER	TEST CONDITIONS		SYMBOL	TYP.	MAX.	UNIT
Maximum instantaneous forward voltage ⁽¹⁾	I _F = 5.0 A	T _J = 25 °C	V _F	0.96	-	V
	I _F = 5.0 A	T _J = 125 °C		0.77	-	
	I _F = 10 A	T _J = 25 °C		1.0	1.2	
	I _F = 10 A	T _J = 125 °C		0.83	0.90	
Maximum reverse current ⁽²⁾	V _R = 300 V	T _J = 25 °C T _J = 125 °C	I _R	0.5 25	5 150	μA
Maximum reverse recovery time	I _F = 0.5 A, I _R = 1.0 A, I _{rr} = 0.25 A		t _{rr}	20	25	ns
Maximum reverse recovery time	I _F = 1.0 A, di/dt = 50 A/μs, V _R = 30 V, I _{rr} = 0.1 I _{RM}		t _{rr}	28	35	ns
Typical softness factor (tb/ta)	I _F = 10 A, di/dt = 200 A/μs, V _R = 200 V, T _J = 125 °C		S	0.36	-	-
Typical reverse recovery current			I _{RM}	7.0	-	ns
Typical stored charge			Q _{rr}	160	-	A
Typical forward recovery time	I _F = 10 A, di/dt = 80 A/μs, V _{FR} = 1.1 x V _{F max.}		t _{fr}	150	-	ns

Notes:

- (1) Pulse test: 300 μs pulse width, 1 % duty cycle
 (2) Pulse test: Pulse width ≤ 40 ms

THERMAL CHARACTERISTICS (T _A = 25 °C unless otherwise noted)				
PARAMETER	SYMBOL	UH10FT	UHB10FT	UNIT
Typical thermal resistance	R _{θJC}	2.0	2.0	°C/W

ORDERING INFORMATION (Example)					
PACKAGE	PREFERRED P/N	UNIT WEIGHT (g)	PACKAGE CODE	BASE QUANTITY	DELIVERY MODE
TO-220AC	UH10FT-E3/4W	1.82	4W	50/tube	Tube
TO-263AB	UHB10FT-E3/4W	1.32	4W	50/tube	Tube
TO-263AB	UHB10FT-E3/8W	1.32	8W	800/reel	Tape and reel

RATINGS AND CHARACTERISTICS CURVES

($T_A = 25\text{ }^\circ\text{C}$ unless otherwise noted)

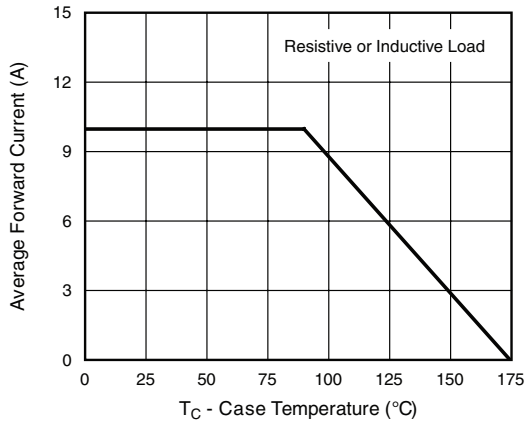

Figure 1. Maximum Forward Current Derating Curve

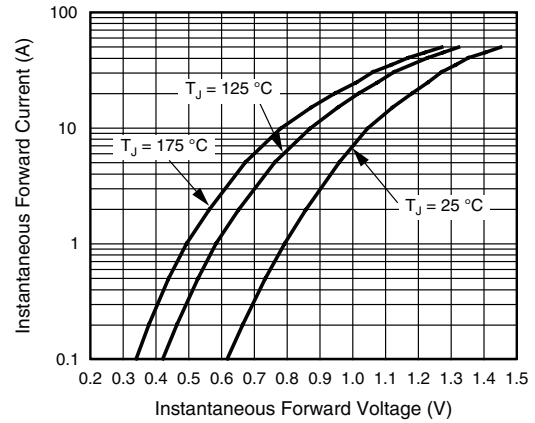

Figure 4. Typical Instantaneous Forward Characteristics

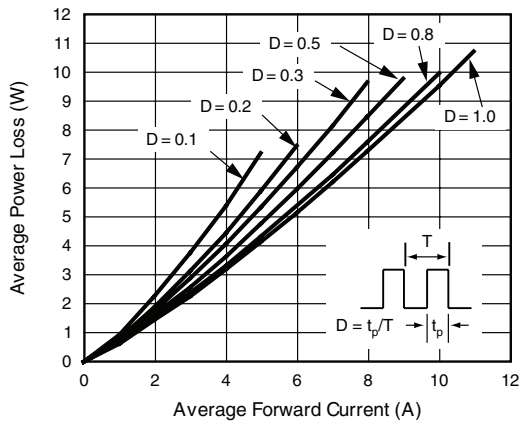

Figure 2. Forward Power Loss Characteristics

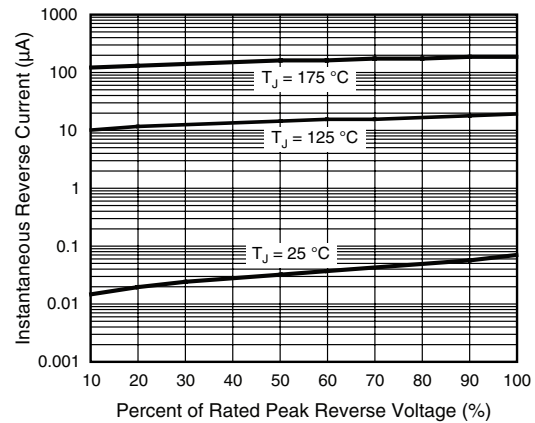

Figure 5. Typical Reverse Leakage Characteristics

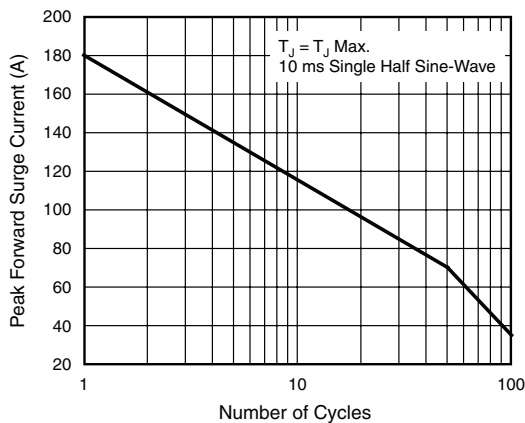

Figure 3. Maximum Non-Repetitive Peak Forward Surge Current

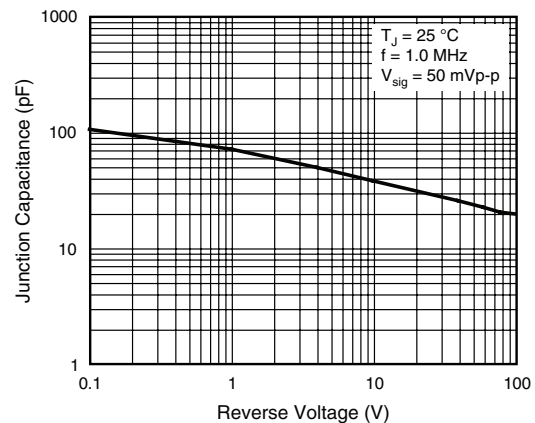
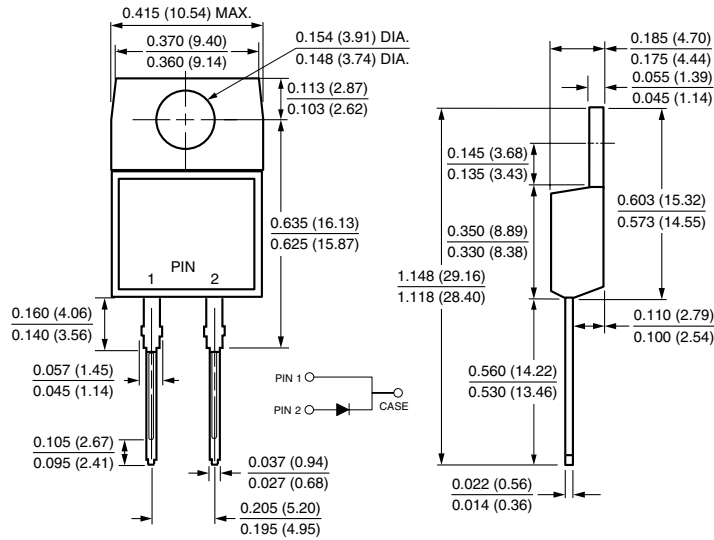

Figure 6. Typical Junction Capacitance



PACKAGE OUTLINE DIMENSIONS in inches (millimeters)

TO-220AC



TO-263AB

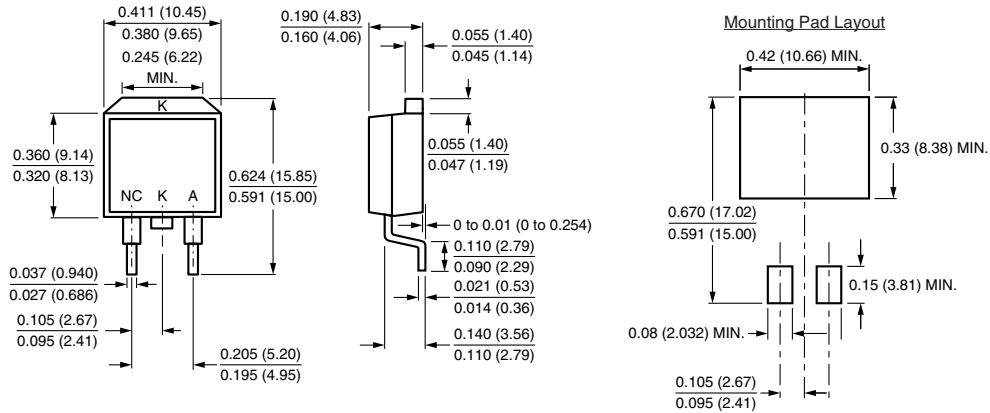



Disclaimer

All product specifications and data are subject to change without notice.

Vishay Intertechnology, Inc., its affiliates, agents, and employees, and all persons acting on its or their behalf (collectively, "Vishay"), disclaim any and all liability for any errors, inaccuracies or incompleteness contained herein or in any other disclosure relating to any product.

Vishay disclaims any and all liability arising out of the use or application of any product described herein or of any information provided herein to the maximum extent permitted by law. The product specifications do not expand or otherwise modify Vishay's terms and conditions of purchase, including but not limited to the warranty expressed therein, which apply to these products.

No license, express or implied, by estoppel or otherwise, to any intellectual property rights is granted by this document or by any conduct of Vishay.

The products shown herein are not designed for use in medical, life-saving, or life-sustaining applications unless otherwise expressly indicated. Customers using or selling Vishay products not expressly indicated for use in such applications do so entirely at their own risk and agree to fully indemnify Vishay for any damages arising or resulting from such use or sale. Please contact authorized Vishay personnel to obtain written terms and conditions regarding products designed for such applications.

Product names and markings noted herein may be trademarks of their respective owners.