

FEATURES

Series reference (2.5 V, 3 V, 4.096 V, 5 V)
 Low quiescent current: 70 μ A maximum
 Current output capability: \pm 5 mA
 Wide supply range: $V_{IN} = V_{OUT} + 200$ mV to 12 V
 Wideband noise (10 Hz to 10 kHz): 50 μ V rms
 Specified temperature range: -40°C to $+125^{\circ}\text{C}$
 Compact, surface-mount SOT-23 package

APPLICATIONS

Portable, battery-powered equipment; for example, notebook computers, cellular phones, pagers, PDAs, GPSs, and DMMs
 Computer workstations; suitable for use with a wide range of video RAMDACs
 Smart industrial transmitters
 PCMCIA cards
 Automotive
 Hard disk drives
 3 V/5 V, 8-bit/12-bit data converters

GENERAL DESCRIPTION

The AD1582/AD1583/AD1584/AD1585 are low cost, low power, low dropout, precision band gap references. These designs are available as 3-terminal (series) devices and are packaged in the compact SOT-23, 3-lead surface-mount package. The versatility of these references makes them ideal for use in battery-powered 3 V or 5 V systems where there can be wide variations in supply voltage and a need to minimize power dissipation.

The superior accuracy and temperature stability of the AD1582/AD1583/AD1584/AD1585 result from the precise matching and thermal tracking of on-chip components. Patented temperature drift curvature correction design techniques minimize the nonlinearities in the voltage output temperature characteristic.

PIN CONFIGURATION

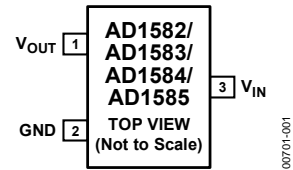

Figure 1. 3-Lead SOT-23-3 (RT Suffix)

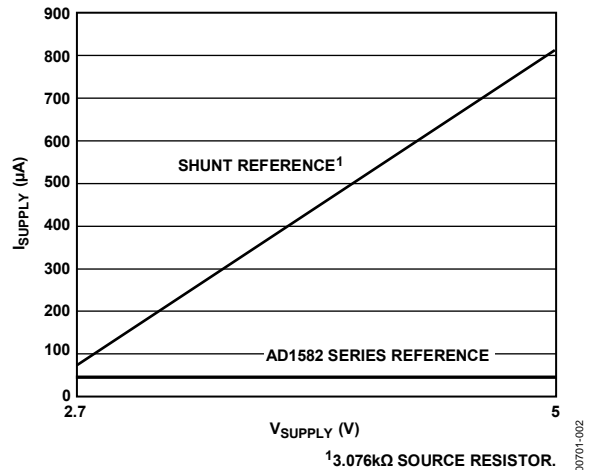

Figure 2. Supply Current (μ A) vs. Supply Voltage (V)

The AD1582/AD1583/AD1584/AD1585 series mode devices source or sink up to 5 mA of load current and operate efficiently with only 200 mV of required headroom supply. These parts draw a maximum 70 μ A of quiescent current with only a 1.0 μ A/V variation with supply voltage. The advantage of these designs over conventional shunt devices is extraordinary. Valuable supply current is no longer wasted through an input series resistor, and maximum power efficiency is achieved at all input voltage levels.

The AD1582/AD1583/AD1584/AD1585 are available in two grades, A and B, and are provided in a tiny footprint, the SOT-23. All grades are specified over the industrial temperature range of -40°C to $+125^{\circ}\text{C}$.

Table 1. AD158x Products, Three Electrical Grades

Electrical Grade	Initial Accuracy			Temperature Coefficient (ppm $^{\circ}\text{C}$)
	AD1582	AD1583/AD1585	AD1584	
B	0.08%	0.10%	0.10%	50
A	0.80%	1.00%	0.98%	100

Rev. I

Information furnished by Analog Devices is believed to be accurate and reliable. However, no responsibility is assumed by Analog Devices for its use, nor for any infringements of patents or other rights of third parties that may result from its use. Specifications subject to change without notice. No license is granted by implication or otherwise under any patent or patent rights of Analog Devices. Trademarks and registered trademarks are the property of their respective owners.

TABLE OF CONTENTS

Features	1	Theory of Operation	10
Applications.....	1	Applications Information	11
Pin Configuration.....	1	Temperature Performance.....	11
General Description	1	Voltage Output Nonlinearity vs. Temperature	11
Revision History	2	Output Voltage Hysteresis.....	12
Specifications.....	3	Supply Current vs. Temperature.....	12
AD1582 Specifications.....	3	Supply Voltage	12
AD1583 Specifications.....	4	AC Performance	12
AD1584 Specifications.....	5	Noise Performance and Reduction	13
AD1585 Specifications.....	6	Turn-On Time	13
Absolute Maximum Ratings.....	7	Dynamic Performance.....	14
ESD Caution.....	7	Outline Dimensions	15
Terminology	8	Ordering Guide	16
Typical Performance Characteristics	9	Package Branding Information	16

REVISION HISTORY

5/10—Rev. H to Rev. I

Changes to Figure 10.....	11
Updated Outline Dimensions	16
Changes to Ordering Guide	16

11/07—Rev. G to Rev. H

Deleted C Grade	Universal
Changes to VOERR Parameter	3
Changes to Ordering Guide	16

6/06—Rev. F to Rev. G

Changes to Features.....	1
Changes to General Description	1

2/06—Rev. E to Rev. F

Updated Format.....	Universal
Changes to Features.....	1
Changes to Table 6.....	7
Changes to Ordering Guide	16

6/05—Rev. D to Rev. E

Changes to Ordering Guide	7
Moved Package Branding Section	7

6/04—Rev. C to Rev. D

Changes to Ordering Guide	6
Updated Outline Dimensions	13

12/02—Rev. B to Rev. C

Changes to Features	1
Changes to General Description	1
Changes to Specifications.....	2
Changes to Absolute Maximum Ratings.....	6
Replaced TPC 3	8
Changes to Temperature Performance Section	9
Replaced Figure 4	9
Changes to Output Voltage Hysteresis Section	10
Updated SOT-23 Package.....	13

3/97—Revision 0: Initial Version

SPECIFICATIONS

AD1582 SPECIFICATIONS

$T_A = T_{MIN}$ to T_{MAX} , $V_{IN} = 5$ V, unless otherwise noted.

Table 2.

Parameter	AD1582A			AD1582B			Unit
	Min	Typ	Max	Min	Typ	Max	
OUTPUT VOLTAGE (@ 25°C) V_O	2.480	2.500	2.520	2.498	2.500	2.502	V
INITIAL ACCURACY ERROR (@ 25°C) V_{OERR}	-20 -0.80		+20 +0.80	-2 -0.08		+2 +0.08	mV %
OUTPUT VOLTAGE TEMPERATURE DRIFT			100			50	ppm/°C
TEMPERATURE COEFFICIENT (TCV _O) -40°C < T_A < +125°C 0°C < T_A < 70°C		40 35	100		18 15	50	ppm/°C ppm/°C
MINIMUM SUPPLY HEADROOM ($V_{IN} - V_{OUT}$)	200			200			mV
LOAD REGULATION 0 mA < I_{OUT} < 5 mA (-40°C to +85°C) 0 mA < I_{OUT} < 5 mA (-40°C to +125°C) -5 mA < I_{OUT} < 0 mA (-40°C to +85°C) -5 mA < I_{OUT} < 0 mA (-40°C to +125°C) -0.1 mA < I_{OUT} < +0.1 mA (-40°C to +85°C) -0.1 mA < I_{OUT} < +0.1 mA (-40°C to +125°C)			0.2 0.4 0.25 0.45 2.7 3.5			0.2 0.4 0.25 0.45 2.7 3.5	mV/mA mV/mA mV/mA mV/mA mV/mA mV/mA
LINE REGULATION $V_{OUT} + 200$ mV < V_{IN} < 12 V $I_{OUT} = 0$ mA			25			25	μV/V
RIPPLE REJECTION ($\Delta V_{OUT}/\Delta V_{IN}$) $V_{IN} = 5$ V ± 100 mV (f = 120 Hz)	80			80			dB
QUIESCENT CURRENT			70			70	μA
SHORT-CIRCUIT CURRENT TO GROUND			15			15	mA
NOISE VOLTAGE (@ 25°C) 0.1 Hz to 10 Hz 10 Hz to 10 kHz		70 50			70 50		μV p-p μV rms
TURN-ON SETTLING TIME TO 0.1% $C_L = 0.2$ μF			100			100	μs
LONG-TERM STABILITY 1000 Hours @ 25°C		100			100		ppm/1000 hr
OUTPUT VOLTAGE HYSTERESIS		115			115		ppm
TEMPERATURE RANGE Specified Performance (A, B, C) Operating Performance (A, B, C)	-40 -55		+125 +125	-40 -55		+125 +125	°C °C

AD1582/AD1583/AD1584/AD1585

AD1583 SPECIFICATIONS

$T_A = T_{MIN}$ to T_{MAX} , $V_{IN} = 5$ V, unless otherwise noted.

Table 3.

Parameter	AD1583A			AD1583B			Unit
	Min	Typ	Max	Min	Typ	Max	
OUTPUT VOLTAGE (@ 25°C) V_O	2.970	3.000	3.030	2.997	3.000	3.003	V
INITIAL ACCURACY ERROR (@ 25°C) V_{OERR}	-30		+30	-3		+3	mV
	-1.0		+1.0	-0.1		+0.1	%
OUTPUT VOLTAGE TEMPERATURE DRIFT			100			50	ppm/°C
TEMPERATURE COEFFICIENT (TCV _O) -40°C < T_A < +125°C		40	100		18	50	ppm/°C
		35			15		ppm/°C
MINIMUM SUPPLY HEADROOM ($V_{IN} - V_{OUT}$)	200			200			mV
LOAD REGULATION							
0 mA < I_{OUT} < 5 mA (-40°C to +85°C)			0.25			0.25	mV/mA
0 mA < I_{OUT} < 5 mA (-40°C to +125°C)			0.45			0.45	mV/mA
-5 mA < I_{OUT} < 0 mA (-40°C to +85°C)			0.40			0.40	mV/mA
-5 mA < I_{OUT} < 0 mA (-40°C to +125°C)			0.6			0.6	mV/mA
-0.1 mA < I_{OUT} < +0.1 mA (-40°C to +85°C)			2.9			2.9	mV/mA
-0.1 mA < I_{OUT} < +0.1 mA (-40°C to +125°C)			3.7			3.7	mV/mA
LINE REGULATION $V_{OUT} + 200$ mV < V_{IN} < 12 V $I_{OUT} = 0$ mA			25			25	μV/V
RIPPLE REJECTION ($\Delta V_{OUT}/\Delta V_{IN}$) $V_{IN} = 5$ V ± 100 mV (f = 120 Hz)	80			80			dB
QUIESCENT CURRENT			70			70	μA
SHORT-CIRCUIT CURRENT TO GROUND			15			15	mA
NOISE VOLTAGE (@ 25°C)		85			85		μV p-p
		60			60		μV rms
TURN-ON SETTLING TIME TO 0.1% $C_L = 0.2$ μF			120			120	μs
LONG-TERM STABILITY 1000 Hours @ 25°C		100			100		ppm/1000 hr
OUTPUT VOLTAGE HYSTERESIS		115			115		ppm
TEMPERATURE RANGE		-40	+125		-40	+125	°C
		-55	+125		-55	+125	°C

AD1584 SPECIFICATIONS

$T_A = T_{MIN}$ to T_{MAX} , $V_{IN} = 5$ V, unless otherwise noted.

Table 4.

Parameter	AD1584A			AD1584B			Unit
	Min	Typ	Max	Min	Typ	Max	
OUTPUT VOLTAGE (@ 25°C) V_O	4.056	4.096	4.136	4.092	4.096	4.100	V
INITIAL ACCURACY ERROR (@ 25°C) V_{OERR}	-40 -0.98		+40 +0.98	-4 -0.1		+4 +0.1	mV %
OUTPUT VOLTAGE TEMPERATURE DRIFT			100			50	ppm/°C
TEMPERATURE COEFFICIENT (TCV _O) -40°C < T_A < +125°C 0°C < T_A < 70°C		40 35	100		18 15	50	ppm/°C ppm/°C
MINIMUM SUPPLY HEADROOM ($V_{IN} - V_{OUT}$)	200			200			mV
LOAD REGULATION 0 mA < I_{OUT} < 5 mA (-40°C to +85°C) 0 mA < I_{OUT} < 5 mA (-40°C to +125°C) -5 mA < I_{OUT} < 0 mA (-40°C to +85°C) -5 mA < I_{OUT} < 0 mA (-40°C to +125°C) -0.1 mA < I_{OUT} < +0.1 mA (-40°C to +85°C) -0.1 mA < I_{OUT} < +0.1 mA (-40°C to +125°C)			0.32 0.52 0.40 0.6 3.2 4.1			0.32 0.52 0.40 0.6 3.2 4.1	mV/mA mV/mA mV/mA mV/mA mV/mA mV/mA
LINE REGULATION $V_{OUT} + 200$ mV < V_{IN} 12 V $I_{OUT} = 0$ mA			25			25	μV/V
RIPPLE REJECTION ($\Delta V_{OUT}/\Delta V_{IN}$) $V_{IN} = 5$ V ± 100 mV (f = 120 Hz)	80			80			dB
QUIESCENT CURRENT			70			70	μA
SHORT-CIRCUIT CURRENT TO GROUND			15			15	mA
NOISE VOLTAGE (@ 25°C) 0.1 Hz to 10 Hz 10 Hz to 10 kHz		110 90			110 90		μV p-p μV rms
TURN-ON SETTLING TIME TO 0.1% $C_L = 0.2$ μF			140			140	μs
LONG-TERM STABILITY 1000 Hours @ 25°C		100			100		ppm/1000 hr
OUTPUT VOLTAGE HYSTERESIS		115			115		ppm
TEMPERATURE RANGE Specified Performance (A, B, C) Operating Performance (A, B, C)	-40 -55		+125 -125	-40 -55		+125 +125	°C °C

AD1582/AD1583/AD1584/AD1585

AD1585 SPECIFICATIONS

@ $T_A = T_{MIN}$ to T_{MAX} , $V_{IN} = 6$ V, unless otherwise noted.

Table 5.

Parameter	AD1585A			AD1585B			Unit
	Min	Typ	Max	Min	Typ	Max	
OUTPUT VOLTAGE (@ 25°C) V_O	4.950	5.000	5.050	4.995	5.000	5.005	V
INITIAL ACCURACY ERROR (@ 25°C) V_{OERR}	-50		+50	-5		+5	mV
	-1.0		+1.0	-0.10		+0.10	%
OUTPUT VOLTAGE TEMPERATURE DRIFT			100			50	ppm/°C
TEMPERATURE COEFFICIENT (TCV _O) -40°C < T_A < 125°C		40	100		18	50	ppm/°C
		35			15		ppm/°C
MINIMUM SUPPLY HEADROOM ($V_{IN} - V_{OUT}$)	200			200			mV
LOAD REGULATION							
0 mA < I_{OUT} < 5 mA (-40°C to +85°C)			0.40			0.40	mV/mA
0 mA < I_{OUT} < 5 mA (-40°C to +125°C)			0.6			0.6	mV/mA
-5 mA < I_{OUT} < 0 mA (-40°C to +85°C)			0.40			0.40	mV/mA
-5 mA < I_{OUT} < 0 mA (-40°C to +125°C)			0.6			0.6	mV/mA
-0.1 mA < I_{OUT} < +0.1 mA (-40°C to +85°C)			4			4	mV/mA
-0.1 mA < I_{OUT} < +0.1 mA (-40°C to +125°C)			4.8			4.8	mV/mA
LINE REGULATION $V_{OUT} + 200$ mV < V_{IN} < 12 V $I_{OUT} = 0$ mA			25			25	μV/V
RIPPLE REJECTION ($\Delta V_{OUT}/\Delta V_{IN}$) $V_{IN} = 6$ V ± 100 mV (f = 120 Hz)	80			80			dB
QUIESCENT CURRENT			70			70	μA
SHORT-CIRCUIT CURRENT TO GROUND			15			15	mA
NOISE VOLTAGE (@ 25°C) 0.1 Hz to 10 Hz		140			140		μV p-p
		100			100		μV rms
TURN-ON SETTLING TIME TO 0.1% $C_L = 0.2$ μF			175			175	μs
LONG-TERM STABILITY 1000 Hours @ 25°C		100			100		ppm/1000 hr
OUTPUT VOLTAGE HYSTERESIS		115			115		ppm
TEMPERATURE RANGE Specified Performance (A, B, C)	-40		+125	-40		+125	°C
	-55		+125	-55		+125	°C

ABSOLUTE MAXIMUM RATINGS

Table 6.

Parameter	Rating
V _{IN} to Ground	12 V
Internal Power Dissipation ¹ SOT-23-3 (RT-3)	400 mW
Storage Temperature Range	65°C to 125°C
Specified Temperature Range AD1582RT/AD1583RT/ AD1584RT/AD1585RT	−40°C to +125°C
Lead Temperature, Soldering Vapor Phase (60 sec)	215°C
Infrared (15 sec)	220°C

¹ Specification is for device in free air at 25°C; SOT-23 package, $\theta_{JA} = 300^{\circ}\text{C}$.

Stresses above those listed under Absolute Maximum Ratings may cause permanent damage to the device. This is a stress rating only; functional operation of the device at these or any other conditions above those indicated in the operational section of this specification is not implied. Exposure to absolute maximum rating conditions for extended periods may affect device reliability.

ESD CAUTION



ESD (electrostatic discharge) sensitive device. Charged devices and circuit boards can discharge without detection. Although this product features patented or proprietary protection circuitry, damage may occur on devices subjected to high energy ESD. Therefore, proper ESD precautions should be taken to avoid performance degradation or loss of functionality.

TERMINOLOGY

Temperature Coefficient (TCV_O)

The change of output voltage over the operating temperature change and normalized by the output voltage at 25°C, expressed in ppm/°C. The equation follows

$$TCV_O[\text{ppm}/^\circ\text{C}] = \frac{V_O(T_2) - V_O(T_1)}{V_O(25^\circ\text{C}) \times (T_2 - T_1)} \times 10^6$$

where:

$$V_O(25^\circ\text{C}) = V_O @ 25^\circ\text{C}.$$

$$V_O(T_1) = V_O @ \text{Temperature 1}.$$

$$V_O(T_2) = V_O @ \text{Temperature 2}.$$

Line Regulation ($\Delta V_O/\Delta V_{IN}$) Definition

The change in output voltage due to a specified change in input voltage. It includes the effects of self-heating. Line regulation is expressed in either percent per volt, parts per million per volt, or microvolts per volt change in input voltage.

Load Regulation ($\Delta V_O/\Delta I_{LOAD}$)

The change in output voltage due to a specified change in load current. It includes the effects of self-heating. Load regulation is expressed in either microvolts per milliampere, parts per million per milliampere, or ohms of dc output resistance.

Long-Term Stability (ΔV_O)

Typical shift of output voltage at 25°C on a sample of parts subjected to an operation life test of 1000 hours at 125°C.

$$\Delta V_O = V_O(t_0) - V_O(t_1)$$

$$\Delta V_O[\text{ppm}] = \frac{V_O(t_0) - V_O(t_1)}{V_O(t_0)} \times 10^6$$

where:

$$V_O(t_0) = V_O @ 25^\circ\text{C} \text{ at Time 0}.$$

$$V_O(t_1) = V_O @ 25^\circ\text{C} \text{ after 1000 hours of operation at } 125^\circ\text{C}.$$

Thermal Hysteresis (V_{O_HYS})

The change of output voltage after the device is cycled through temperatures from +25°C to -40°C to +85°C and back to +25°C. This is a typical value from a sample of parts put through such a cycle

$$V_{O_HYS} = V_O(25^\circ\text{C}) - V_{O_TC}$$

$$V_{O_HYS}[\text{ppm}] = \frac{V_O(25^\circ\text{C}) - V_{O_TC}}{V_O(25^\circ\text{C})} \times 10^6$$

where:

$$V_O(25^\circ\text{C}) = V_O \text{ at } 25^\circ\text{C}.$$

$$V_{O_TC} = V_O \text{ at } 25^\circ\text{C} \text{ after temperature cycle at } +25^\circ\text{C} \text{ to } -40^\circ\text{C} \text{ to } +85^\circ\text{C} \text{ and back to } +25^\circ\text{C}.$$

Operating Temperature

The temperature extremes at which the device can still function. Parts can deviate from their specified performance outside the specified temperature range.

TYPICAL PERFORMANCE CHARACTERISTICS

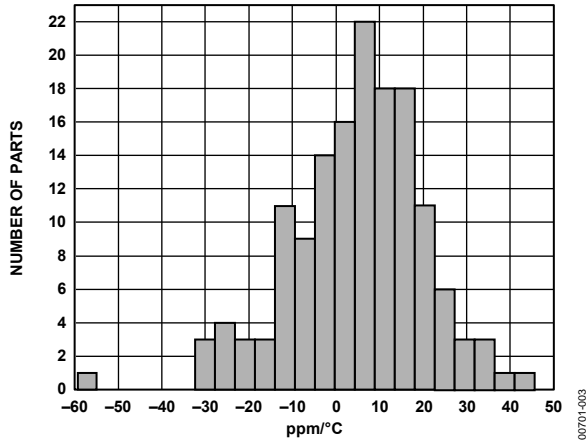

Figure 3. Typical Output Voltage Temperature Drift Distribution

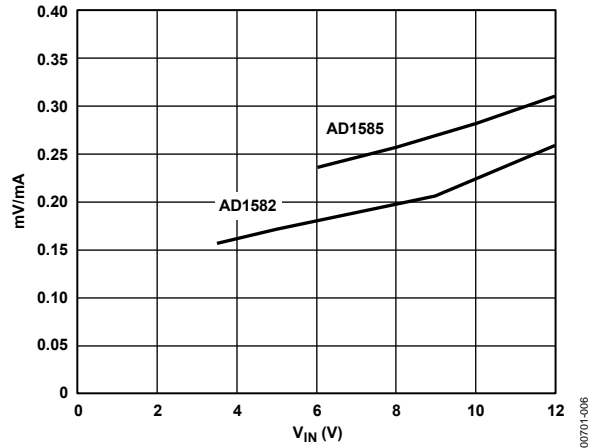

Figure 6. Load Regulation vs. V_{IN}

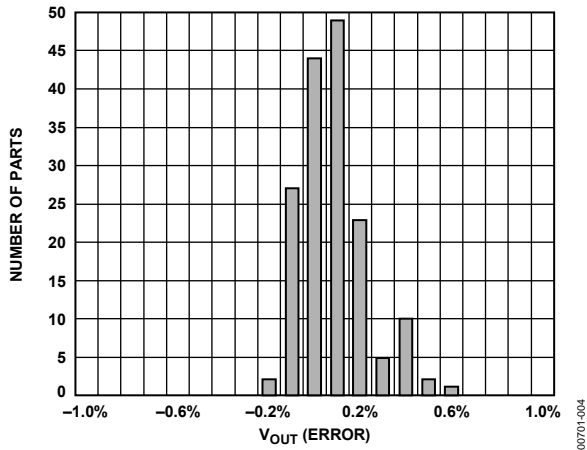

Figure 4. Typical Output Voltage Error Distribution

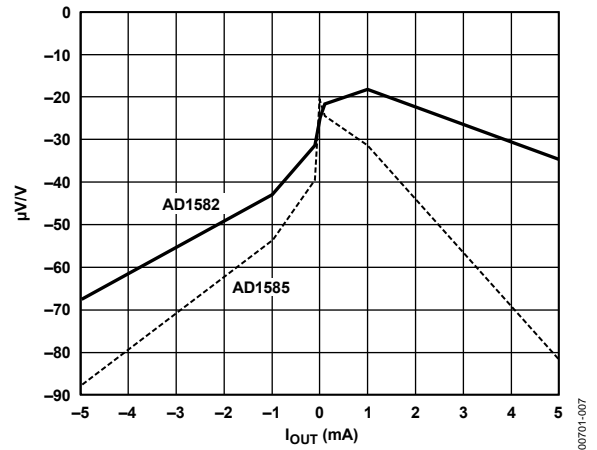

Figure 7. Line Regulation vs. I_{LOAD}

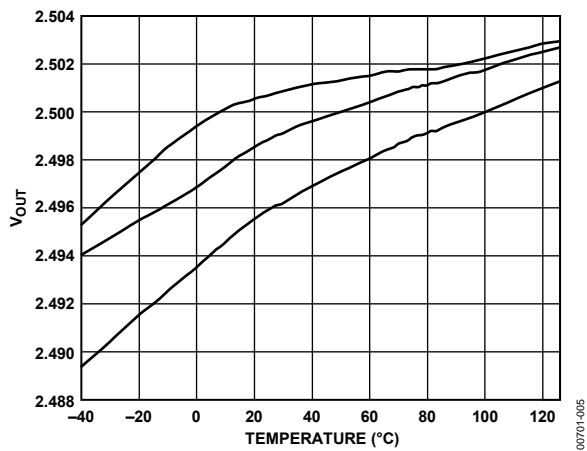

Figure 5. Typical Temperature Drift Characteristic Curves

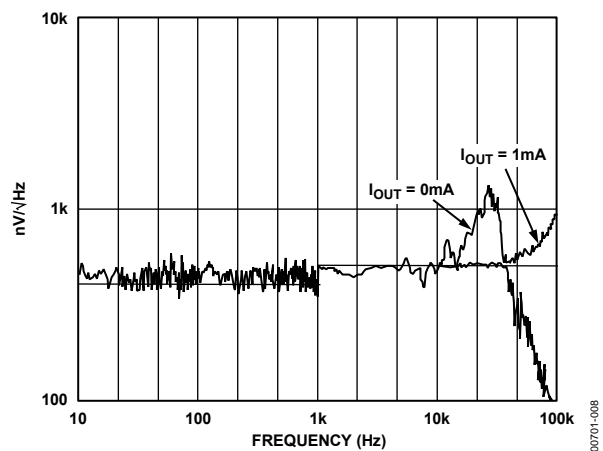

Figure 8. Noise Spectral Density

THEORY OF OPERATION

The AD1582/AD1583/AD1584/AD1585 use the band gap concept to produce stable, low temperature coefficient voltage references suitable for high accuracy data acquisition components and systems. These parts of precision references use the underlying temperature characteristics of a silicon transistor's base emitter voltage in the forward-biased operating region. Under this condition, all such transistors have a $-2 \text{ mV}/^\circ\text{C}$ temperature coefficient (TC) and a V_{BE} that, when extrapolated to absolute zero, 0 K (with collector current proportional to absolute temperature), approximates the silicon band gap voltage. By summing a voltage that has an equal and opposite temperature coefficient of $2 \text{ mV}/^\circ\text{C}$ with the V_{BE} of a forward-biased transistor, an almost 0 TC reference can be developed. In the AD1582/AD1583/AD1584/AD1585 simplified circuit diagram shown in Figure 9, such a compensating voltage, V1, is derived by driving two transistors at different current densities and amplifying the resultant V_{BE} difference (ΔV_{BE} , which has a positive TC). The sum of V_{BE} and V1 (V_{BG}) is then buffered and amplified to produce stable reference voltage outputs of 2.5 V, 3 V, 4.096 V, and 5 V.

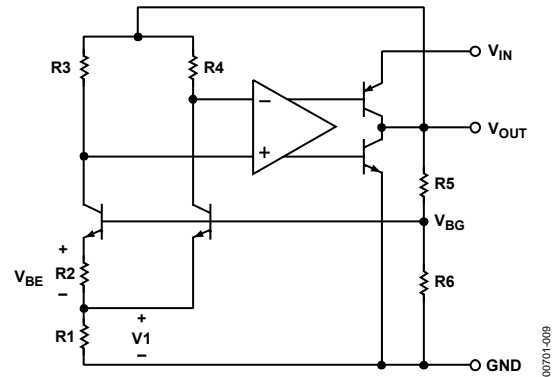

Figure 9. Simplified Schematic

00701-066

APPLICATIONS INFORMATION

The AD1582/AD1583/AD1584/AD1585 are series references that can be used for many applications. To achieve optimum performance with these references, only two external components are required. Figure 10 shows the AD1582/AD1583/AD1584/AD1585 configured for operation under all loading conditions. With a simple 4.7 μF capacitor attached to the input and a 1 μF capacitor applied to the output, the devices can achieve specified performance for all input voltage and output current requirements. For best transient response, add a 0.1 μF capacitor in parallel with the 4.7 μF capacitor. While a 1 μF output capacitor can provide stable performance for all loading conditions, the AD1582/AD1583/AD1584/AD1585 can operate under low ($-100 \mu\text{A} < I_{\text{OUT}} < +100 \mu\text{A}$) current conditions with just a 0.2 μF output capacitor. The 4.7 μF capacitor on the input can be reduced to 1 μF in this condition.

Unlike conventional shunt reference designs, the AD1582/AD1583/AD1584/AD1585 provide stable output voltages at constant operating current levels. When properly decoupled, as shown in Figure 10, these devices can be applied to any circuit and provide superior low power solutions.

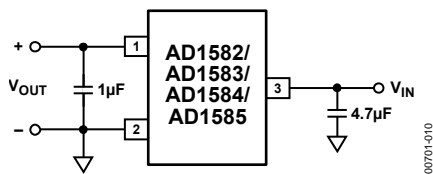

Figure 10. Typical Connection Diagram

TEMPERATURE PERFORMANCE

The AD1582/AD1583/AD1584/AD1585 are designed for applications where temperature performance is important. Extensive temperature testing and characterization ensure that device performance is maintained over the specified temperature range.

The error band guaranteed with the AD1582/AD1583/AD1584/AD1585 is the maximum deviation from the initial value at 25°C. Therefore, for a given grade of the AD1582/AD1583/AD1584/AD1585, the designer can easily determine the maximum total error by summing initial accuracy and temperature variation. For example, for the AD1582BRT, the initial tolerance is $\pm 2 \text{ mV}$, and the temperature error band is $\pm 8 \text{ mV}$; therefore, the reference is guaranteed to be $2.5 \text{ V} \pm 10 \text{ mV}$ from -40°C to $+125^\circ\text{C}$.

Figure 11 shows the typical output voltage drift for the AD1582/AD1583/AD1584/AD1585 and illustrates the methodology. The box in Figure 11 is bounded on the x-axis by operating temperature extremes. It is bounded on the y-axis by the maximum and minimum output voltages observed over the operating temperature range. The slope of the diagonal drawn from the initial output value at 25°C to the output values at $+125^\circ\text{C}$ and -40°C determines the performance grade of the device.

Duplication of these results requires a test system that is highly accurate with stable temperature control. Evaluation of the AD1582/AD1583/AD1584/AD1585 produces curves similar to those in Figure 5 and Figure 11, but output readings can vary depending on the test methods and test equipment used.

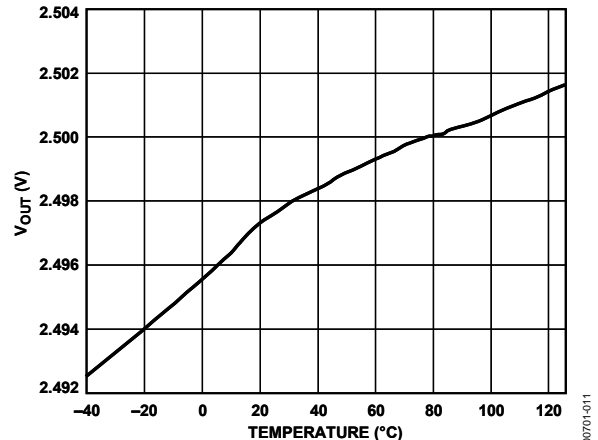

Figure 11. Output Voltage vs. Temperature

VOLTAGE OUTPUT NONLINEARITY VS. TEMPERATURE

When using a voltage reference with data converters, it is important to understand the impact that temperature drift can have on converter performance. The nonlinearity of the reference output drift represents additional error that cannot be easily calibrated out of the overall system. To better understand the impact such a drift can have on a data converter, refer to Figure 12, where the measured drift characteristic is normalized to the endpoint average drift. The residual drift error for the AD1582/AD1583/AD1584/AD1585 of approximately 200 ppm demonstrates that these parts are compatible with systems that require 12-bit accurate temperature performance.

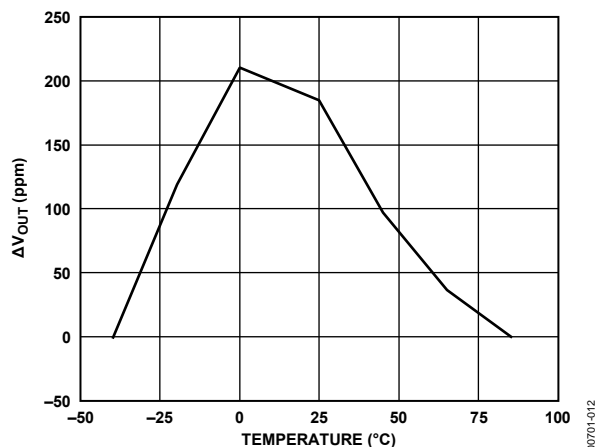

Figure 12. Residual Drift Error

AD1582/AD1583/AD1584/AD1585

OUTPUT VOLTAGE HYSTERESIS

High performance industrial equipment manufacturers can require the AD1582/AD1583/AD1584/AD1585 to maintain a consistent output voltage error at 25°C after the references are operated over the full temperature range. All references exhibit a characteristic known as output voltage hysteresis; however, the AD1582/AD1583/AD1584/AD1585 are designed to minimize this characteristic. This phenomenon can be quantified by measuring the change in the +25°C output voltage after temperature excursions from +125°C to +25°C and from -40°C to +25°C. Figure 13 displays the distribution of the AD1582/AD1583/AD1584/AD1585 output voltage hysteresis.

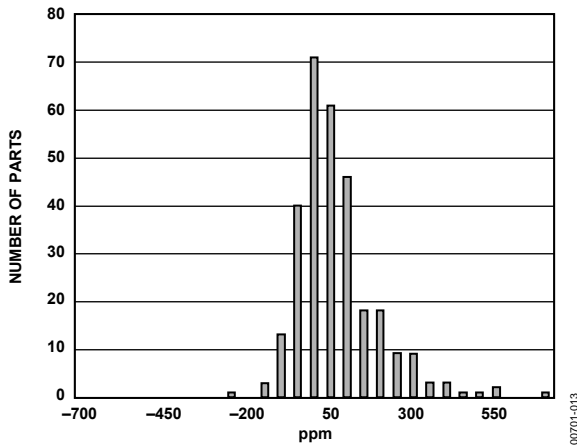

Figure 13. Output Voltage Hysteresis Distribution

SUPPLY CURRENT VS. TEMPERATURE

The quiescent current for the AD1582/AD1583/AD1584/AD1585 varies slightly over temperature and input supply range. Figure 14 illustrates the typical performance for the AD1582/AD1583/AD1584/AD1585 reference when varying both temperature and supply voltage. As is evident from Figure 14, the AD1582/AD1583/AD1584/AD1585 supply current increases only 1.0 $\mu\text{A}/\text{V}$, making this device extremely attractive for use in applications where there can be wide variations in supply voltage and a need to minimize power dissipation.

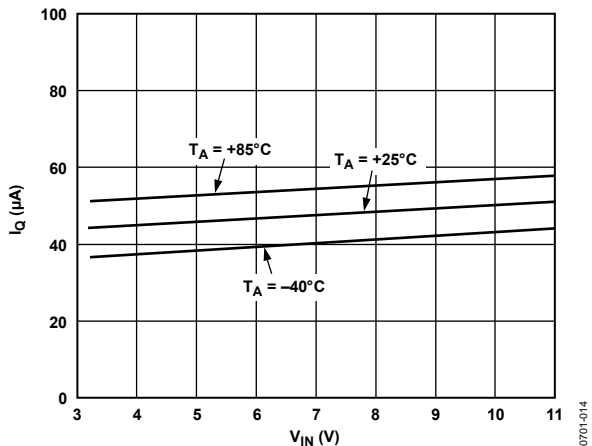

Figure 14. Typical Supply Current over Temperature

SUPPLY VOLTAGE

One of the ideal features of the AD1582/AD1583/AD1584/AD1585 is low supply voltage headroom. The parts can operate at supply voltages as low as 200 mV above V_{OUT} and up to 12 V. However, if negative voltage is inadvertently applied to V_{IN} with respect to ground, or any negative transient >5 V is coupled to V_{IN} , the device can be damaged.

AC PERFORMANCE

To apply the AD1582/AD1583/AD1584/AD1585, it is important to understand the effects of dynamic output impedance and power supply rejection. In Figure 15, a voltage divider is formed by the AD1582/AD1583/AD1584/AD1585 output impedance and by the external source impedance. Figure 16 shows the effect of varying the load capacitor on the reference output. Power supply rejection ratio (PSRR) should be determined when characterizing the ac performance of a series voltage reference. Figure 17 shows a test circuit used to measure PSRR, and Figure 18 demonstrates the ability of the AD1582/AD1583/AD1584/AD1585 to attenuate line voltage ripple.

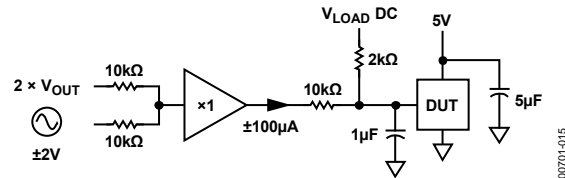

Figure 15. Output Impedance Test Circuit

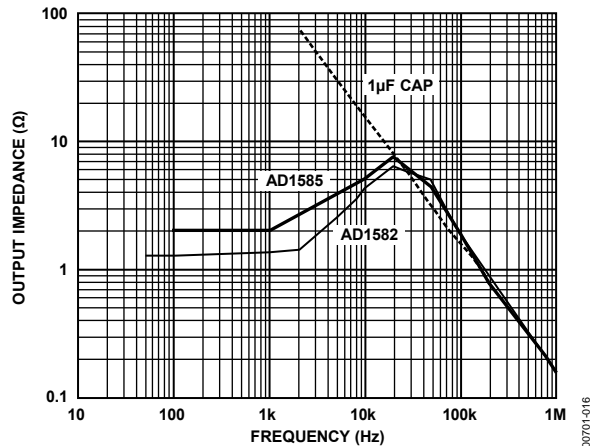

Figure 16. Output Impedance vs. Frequency

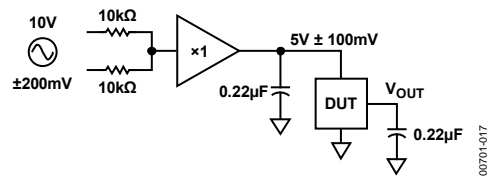

Figure 17. Ripple Rejection Test Circuit

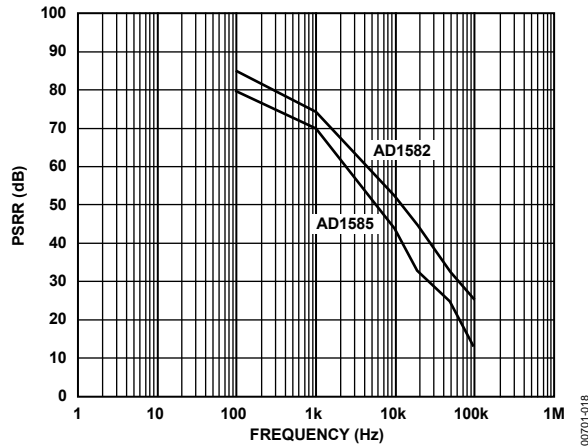

Figure 18. Ripple Rejection vs. Frequency

NOISE PERFORMANCE AND REDUCTION

The noise generated by the AD1582/AD1583/AD1584/AD1585 is typically less than 70 μV p-p over the 0.1 Hz to 10 Hz frequency band. Figure 19 shows the 0.1 Hz to 10 Hz noise of a typical AD1582/AD1583/AD1584/AD1585. The noise measurement is made with a high gain band-pass filter. Noise in a 10 Hz to 10 kHz region is approximately 50 μV rms. Figure 20 shows the broadband noise of a typical AD1582/AD1583/AD1584/AD1585. If further noise reduction is desired, add a 1-pole, low-pass filter between the output pin and ground. A time constant of 0.2 ms has a -3 dB point at roughly 800 Hz and reduces the high frequency noise to about 16 μV rms. It should be noted, however, that while additional filtering on the output can improve the noise performance of the AD1582/AD1583/AD1584/AD1585, the added output impedance can degrade the ac performance of the references.

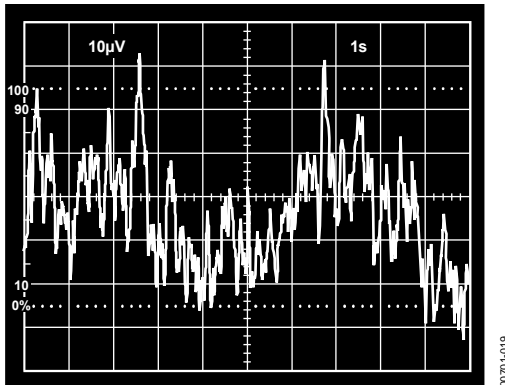

Figure 19. 10 Hz to 10 kHz Wideband Noise

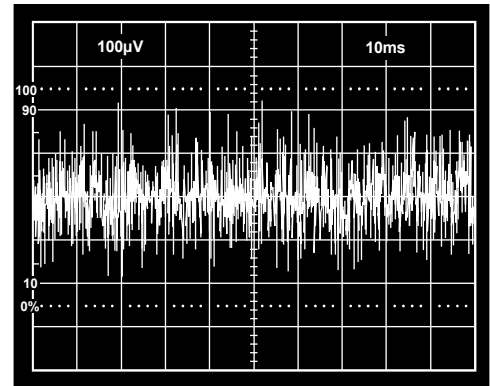

Figure 20. 1 Hz to 10 Hz Voltage Noise

TURN-ON TIME

Many low power instrument manufacturers are concerned with the turn-on characteristics of the components used in their systems. Fast turn-on components often enable the end user to save power by keeping power off when not needed. Turn-on settling time is defined as the time required, after the application of power (cold start), for the output voltage to reach its final value within a specified error. The two major factors affecting this are the active circuit settling time and the time required for the thermal gradients on the chip to stabilize. Figure 21 shows the turn-on settling and transient response test circuit. Figure 22 shows the turn-on characteristics of the AD1582/AD1583/AD1584/AD1585. These characteristics are generated from cold-start operation and represent the true turn-on waveform after power-up. Figure 23 shows the fine settling characteristics of the AD1582/AD1583/AD1584/AD1585. Typically, the reference settles to within 0.1% of its final value in about 100 μs .

The device can momentarily draw excessive supply current when V_{SUPPLY} is slightly below the minimum specified level. Power supply resistance must be low enough to ensure reliable turn-on. Fast power supply edges minimize this effect.

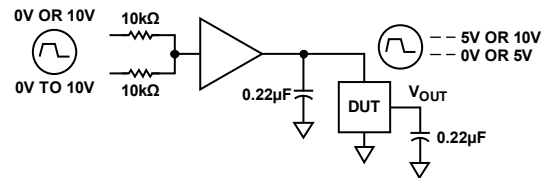

Figure 21. Turn-On/Transient Response Test Circuit

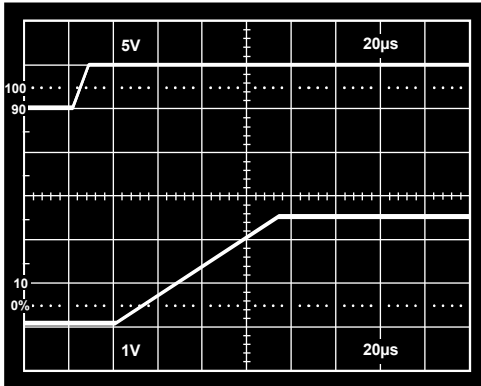

Figure 22. Turn-On Characteristics

00701-022

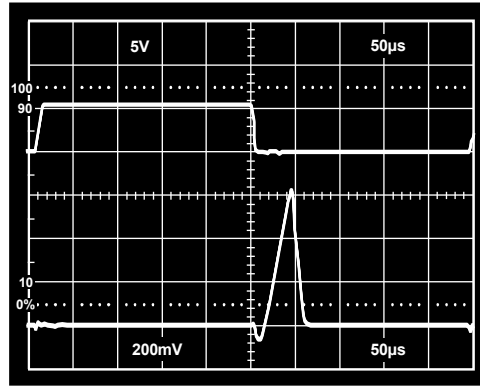

Figure 24. Line Transient Response

00701-024

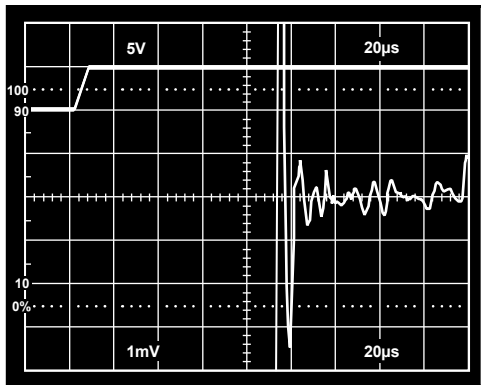

Figure 23. Turn-On Settling

00701-023

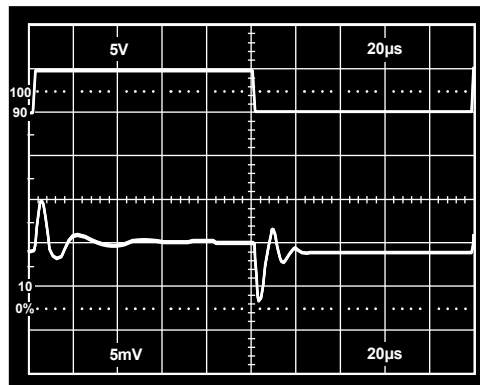

Figure 25. Load Transient Response (0 mA to 5 mA Load)

00701-025

DYNAMIC PERFORMANCE

Many ADCs and DACs present transient current loads to the reference and poor reference response can degrade converter performance. The AD1582/AD1583/AD1584/AD1585 provide superior static and dynamic line and load regulation. Because these series references are capable of both sourcing and sinking large current loads, they exhibit excellent settling characteristics.

Figure 24 displays the line transient response for the AD1582/AD1583/AD1584/AD1585. The circuit used to perform such a measurement is shown in Figure 21, where the input supply voltage is toggled from 5 V to 10 V, and the input and output capacitors are each 0.22 μ F.

Figure 25 and Figure 26 show the load transient settling characteristics for the AD1582/AD1583/AD1584/AD1585 when load current steps of 0 mA to +5 mA and 0 mA to -1 mA are applied. The input supply voltage remains constant at 5 V; the input decoupling and output load capacitors are 4.7 μ F and 1 μ F, respectively; and the output current is toggled. For both positive and negative current loads, the reference responses settle very quickly and exhibit initial voltage spikes of less than 10 mV.

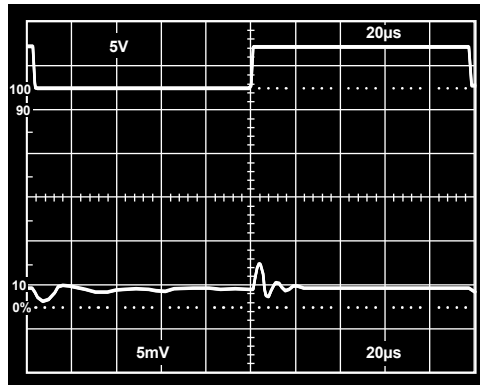
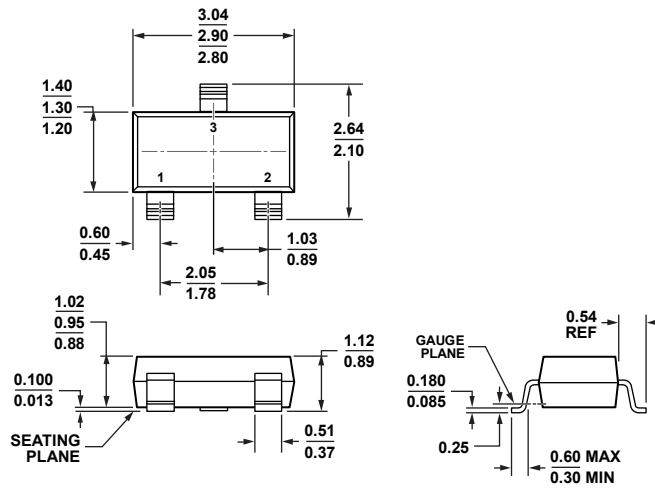

Figure 26. Load Transient Response (0 mA to -1 mA Load)

00701-026

OUTLINE DIMENSIONS



COMPLIANT TO JEDEC STANDARDS TO-236-AB

Figure 27. 3-Lead Small Outline Transistor Package [SOT-23-3] (RT-3)

Dimensions shown in millimeters

011905-C

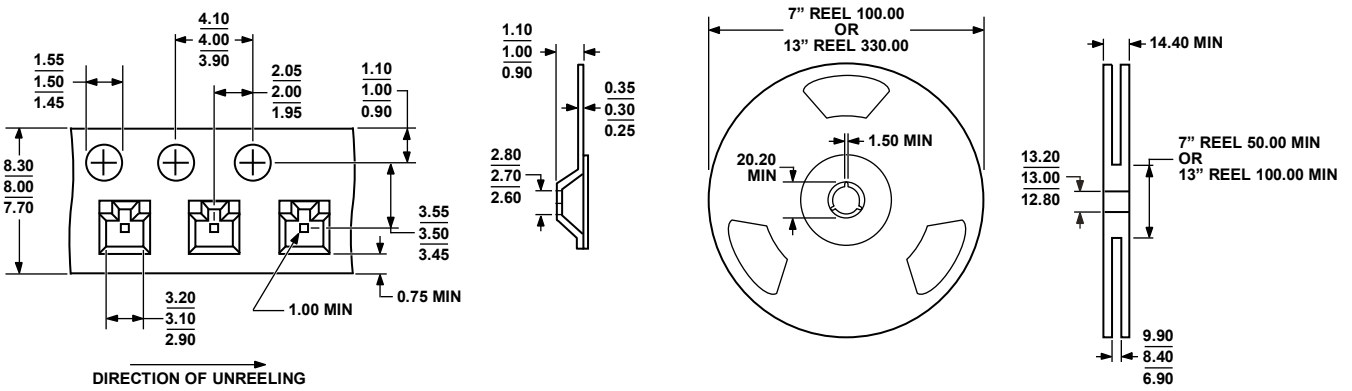

Figure 28. SOT-23 Tape and Reel Outline Dimension (RT-3)

Dimensions shown in millimeters

053006-0

AD1582/AD1583/AD1584/AD1585

ORDERING GUIDE

Model ¹	Output Voltage (V)	Accuracy (mV)	Initial Accuracy (%)	Initial Temp. Coefficient (ppm/°C)	Package Description	Package Option	Branding ²	No. of Parts Banding per Reel
AD1582ART-REEL7	2.50	20	0.80	100	SOT-23-3	RT-3	2A	3,000
AD1582ARTZ-R2	2.50	20	0.80	100	SOT-23-3	RT-3	R1Z	250
AD1582ARTZ-REEL7	2.50	20	0.80	100	SOT-23-3	RT-3	R1Z	3,000
AD1582BRT-REEL7	2.50	2	0.08	50	SOT-23-3	RT-3	2B	3,000
AD1582BRTZ-REEL7	2.50	2	0.08	50	SOT-23-3	RT-3	R20	3,000
AD1583ART-REEL7	3.00	30	1.00	100	SOT-23-3	RT-3	3A	3,000
AD1583ARTZ-R2	3.00	30	1.00	100	SOT-23-3	RT-3	R22	250
AD1583ARTZ-REEL7	3.00	30	1.00	100	SOT-23-3	RT-3	R22	3,000
AD1583BRT-REEL7	3.00	3	0.10	50	SOT-23-3	RT-3	3B	3,000
AD1583BRTZ-REEL7	3.00	3	0.10	50	SOT-23-3	RT-3	R23	3,000
AD1584ARTZ-R2	4.096	40	0.98	100	SOT-23-3	RT-3	R25	250
AD1584ARTZ-REEL7	4.096	40	0.98	100	SOT-23-3	RT-3	R25	3,000
AD1584BRTZ-REEL7	4.096	4	0.10	50	SOT-23-3	RT-3	R26	3,000
AD1585ARTZ-R2	5.00	50	1.00	100	SOT-23-3	RT-3	R28	250
AD1585ARTZ-REEL7	5.00	50	1.00	100	SOT-23-3	RT-3	R28	3,000
AD1585BRTZ-REEL7	5.00	5	0.10	50	SOT-23-3	RT-3	R29	3,000

¹ Z = RoHS Compliant Part.

² See Package Branding Information section.

PACKAGE BRANDING INFORMATION

This branding information is only for nonPb-free versions. Four fields identify the device:

First field, product identifier; for example, a 2/3/4/5 identifies the generic as AD1582/AD1583/AD1584/AD1585

Second field, device grade, which can be A, B, or C

Third field, calendar year of processing: 7 for 1997..., A for 2001...

Fourth field, two-week window within the calendar year; for example, letters A to Z to represent a two-week window starting with "A" for the first two weeks of January.