

TOSHIBA CCD LINEAR IMAGE SENSOR CCD(Charge Coupled Device)

TCD1703C

The TCD1703C is a high sensitive and low dark current 7500 elements CCD image sensor.

The sensor is designed for facsimile, imagescanner and OCR.

The device contains a row of 7500 elements photodiodes which provide a 24 lines / mm (600DPI) across a A3 size paper. The device is operated by 5V (pulse), and 12V power supply.

FEATURES

- Number of Image Sensing Elements : 7500 elements
- Image Sensing Element Size : 7 μ m by 7 μ m on 7 μ m centers
- Photo Sensing Region : High sensitive and low voltage dark signal pn photodiode
- Clock : 2 phase (5V)
- Package : 22pin DIP

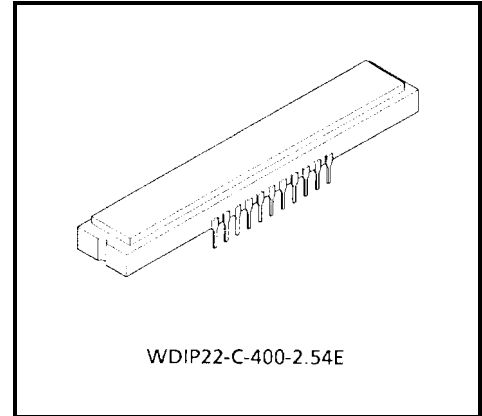

Weight : 6.6g (Typ.)

MAXIMUM RATINGS (Note 1)

CHARACTERISTIC	SYMBOL	RATING	UNIT
Clock Pulse Voltage	V_{ϕ}	-0.3~8	V
Shift Pulse Voltage	V_{SH}		
Reset Pulse Voltage	V_{RS}		
Clamp Pulse Voltage	V_{CP}		
Power Supply Voltage	V_{OD}		
Operating Temperature	T_{opr}	-25~60	
Storage Temperature	T_{stg}	-40~100	°C

Note 1: All voltage are with respect to SS terminals (Ground).

PIN CONNECTION

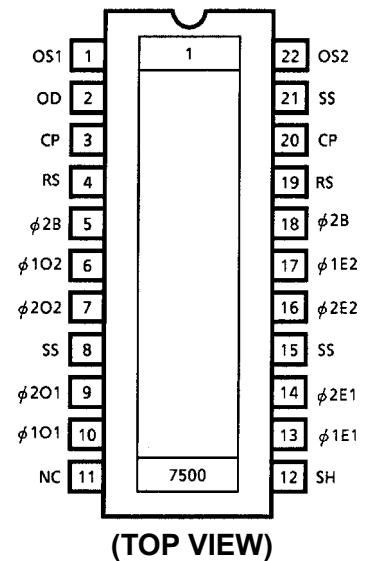

CIRCUIT DIAGRAM

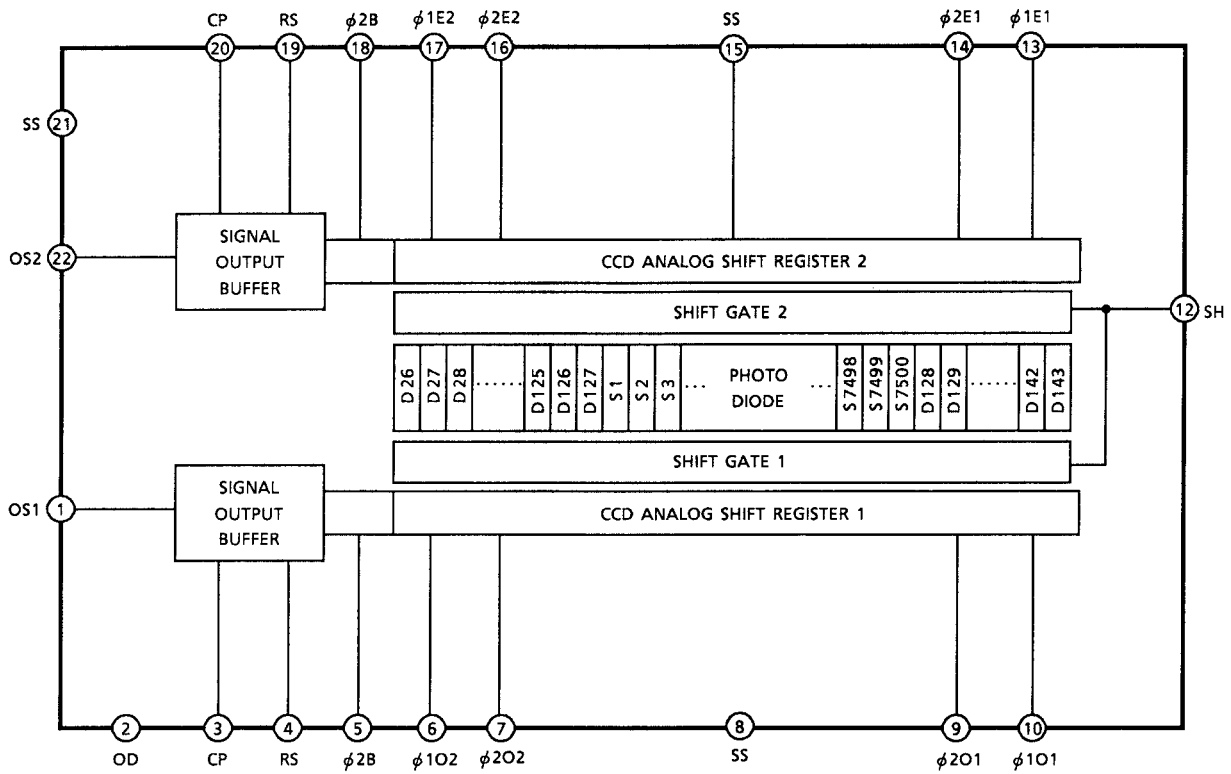

PIN NAMES

φ1E, O	Clock (Phase 1)
φ2E, O	Clock (Phase 2)
φ2B	Final Stage Clock (Phase 2)
SH	Shift Gate
RS	Reset Gate
CP	Clamp Gate
OS1	Signal Output 1
OS2	Signal Output 2
OD	Power
SS	Ground
NC	Non Connection

OPTICAL / ELECTRICAL CHARACTERISTICS

(Ta=25°C, V_{OD}=12V, V_φ=V_{SH}=V_{RS}=V_{CP}=5V (PULSE), f_φ=1MHz,
t_{INT} (INTEGRATION TIME)=10ms, LIGHT SOURCE=DAYLIGHT FLUORESCENT LAMP,
LOAD RESISTANCE=100kΩ)

CHARACTERISTIC	SYMBOL	MIN.	TYP.	MAX.	UNIT	NOTE
Sensitivity	R	12	15	18	V / lx·s	
Photo Response Non Uniformity	PRNU	—	3	10	%	(Note 2)
	PRNU (3)	—	6	12	mV	(Note 8)
Saturation Output Voltage	V _{SAT}	1.5	2.0	—	V	(Note 3)
Saturation Exposure	SE	0.08	0.13	—	lx·s	(Note 4)
Dark Signal Voltage	V _{DRK}	—	1.2	3	mV	(Note 5)
Dark Signal Non Uniformity	DSNU	—	2.5	4	mV	(Note 5)
DC Power Dissipation	P _D	—	350	400	mW	
Total Transfer Efficiency	TTE	92	98	—	%	
Output Impedance	Z _o	—	0.2	1	kΩ	
Dynamic Range	DR	—	1660	—	—	(Note 6)
DC Signal Output Voltage	V _{OS1}	4.0	5.5	7.0	V	(Note 7)
	V _{OS2}	4.0	5.5	7.0		
DC Differential Error Voltage	V _{OS1} -V _{OS2}	—	—	300	mV	
Random Noise	ND _σ	—	1.0	—	mV	(Note 9)

Note 2: Measured at 50% of SE (Typ.)

$$\text{Definition of PRNU : PRNU} = \frac{\Delta\bar{\chi}}{\bar{\chi}} \times 100(\%)$$

Where $\bar{\chi}$ is average of total signal outputs and $\Delta\bar{\chi}$ is maximum deviation from $\bar{\chi}$ under uniform illumination.
(Channel 1)

In the case of 3750 elements (Channel 2), the condition is the same as above too.

Note 3: V_{SAT} is defined as minimum saturation output voltage of all effective pixels.

$$\text{Note 4: Definition of SE : SE} = \frac{V_{SAT}}{R} (\text{lx}\cdot\text{s})$$

Note 5: V_{DRK} is defined as average dark signal voltage of all effective pixels.

DSNU is defined as different voltage between V_{DRK} and V_{MDK} when V_{MDK} is maximum dark signal voltage.

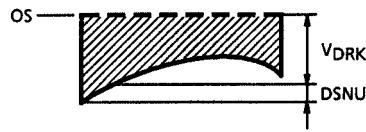

Note 6: Definition of DR : $DR = \frac{V_{SAT}}{V_{DRK}}$

V_{DRK} is proportional to t_{INT} (Integration Time).

So the shorter t_{INT} condition makes wider DR values.

Note 7: DC signal output voltage and DC compensation output voltage are defined as follows:

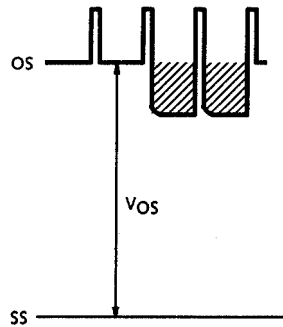

Note 8: PRNU (3) is defined as maximum voltage with next pixel, where measured 5% of SE (Typ.)

Note 9: Random noise is defined as the standard deviation (sigma) of the output level difference between two adjacent effective pixels under no illumination (i.e. dark condition) calculated by the following procedure.

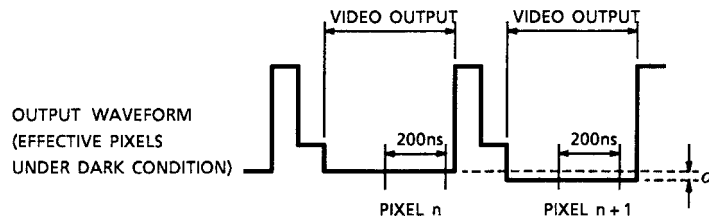

- 1) Two adjacent pixels (pixel n and n+1) in one reading are fixed as measurement points.
- 2) Each of the output levels at video output periods averaged over 200 nanosecond period to get V_n and V_{n+1} .

3) V_{n+1} is subtracted from V_n to get ΔV

$$\Delta V = V_n - V_{n+1}$$

4) The standard deviation of ΔV is calculated after procedure 2) and 3) are repeated 30 times (30 readings).

$$\overline{\Delta V} = \frac{1}{30} \sum_{i=1}^{30} |\Delta V_i| \quad \sigma = \sqrt{\frac{1}{30} \sum_{i=1}^{30} (|\Delta V_i| - \overline{\Delta V})^2}$$

5) Procedure 2), 3) and 4) are repeated 10 times to get 10 sigma values.

$$\overline{\sigma} = \frac{1}{10} \sum_{j=1}^{10} \sigma_j$$

6) $\overline{\sigma}$ value calculated using the above procedure is observed $\sqrt{2}$ times larger than that measured relative to the ground level. So we specify the random noise as follows.

$$\text{Random noise} = \frac{1}{\sqrt{2}} \overline{\sigma}$$

OPERATING CONDITION

CHARACTERISTIC		SYMBOL	MIN.	TYP.	MAX.	UNIT
Clock Pulse Voltage	"H" Level	$V_{\phi 1E, O}$ $V_{\phi 2E, O}$	4.5	5	5.5	V
	"L" Level		0	—	0.5	
Final Stage Clock Voltage	"H" Level	$V_{\phi 2B}$	4.5	5	5.5	V
	"L" Level		0	—	0.5	
Shift Pulse Voltage	"H" Level	V_{SH}	4.5	5	5.5	V
	"L" Level		0	—	0.5	
Reset Pulse Voltage	"H" Level	V_{RS}	4.5	5	5.5	V
	"L" Level		0	—	0.5	
Clamp Pulse Voltage	"H" Level	V_{CP}	4.5	5	5.5	V
	"L" Level		0	—	0.5	
Power Supply Voltage		V_{OD}	11.4	12.0	13.0	V

CLOCK CHARACTERISTICS (Ta=25°C)

CHARACTERISTIC		SYMBOL	MIN.	TYP.	MAX.	UNIT
Clock Pulse Frequency		f_{ϕ}	—	1	20	MHz
Reset Pulse Frequency		f_{RS}	—	1	20	MHz
Clock Capacitance	(Note 10)	$C_{\phi E}$	—	300	—	pF
		$C_{\phi O}$	—	300	—	
Final Stage Clock Capacitance		$C_{\phi B}$	—	10	20	pF
Shift Gate Capacitance		C_{SH}	—	60	—	pF
Reset Gate Capacitance		C_{RS}	—	10	20	pF
Clamp Gate Capacitance		C_{CP}	—	10	20	pF

Note 10: $V_{OD}=12V$

TIMING CHART

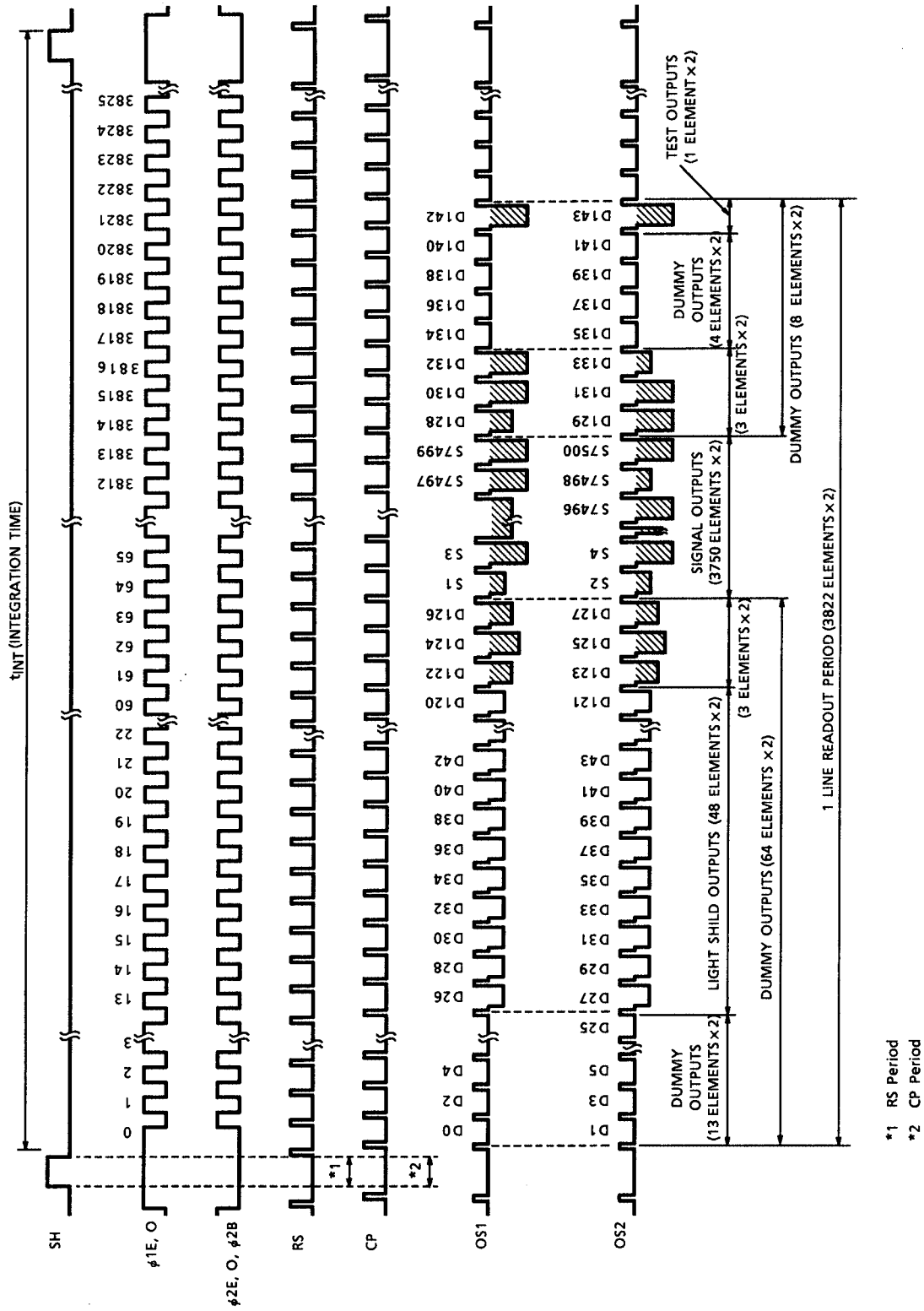

*1 RS Period
*2 CP Period

TIMING REQUIREMENTS

SH, $\phi 1$ Timing

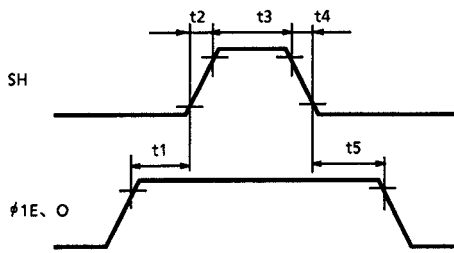

$\phi 2$, RS, CP, OS Timing

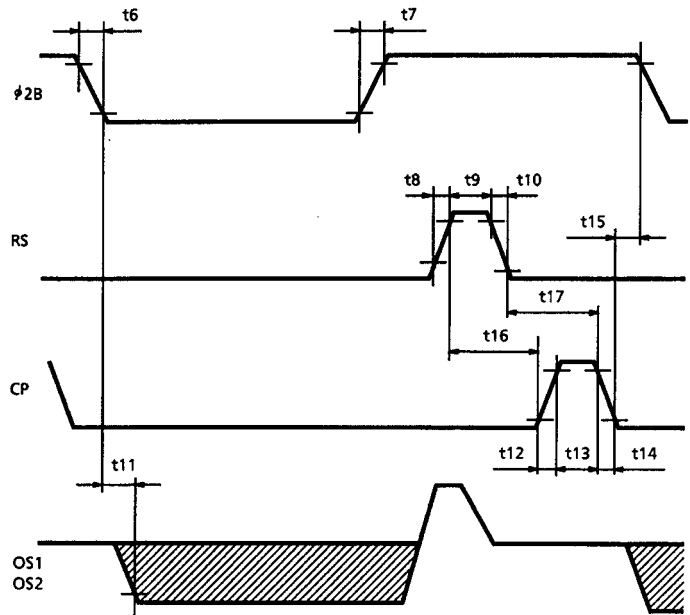

SH, RS, CP Timing

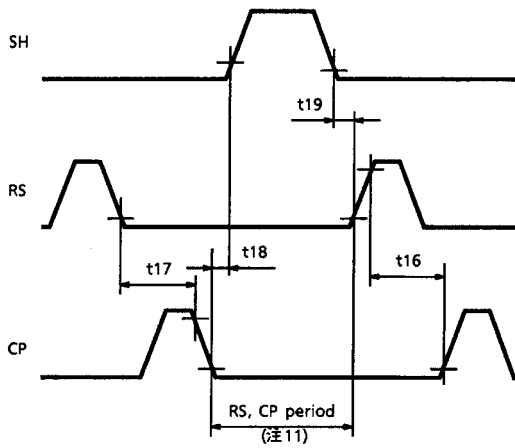

$\phi 1$, $\phi 2$ CROSS POINT

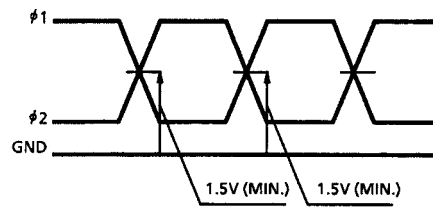

Note 11: Each RS and CP pins put to Low level during this period.

CHARACTERISTIC	SYMBOL	MIN.	TYP. (Note 12)	MAX.	UNIT
Pulse Timing of SH and ϕ 1E, ϕ 1O	t1, t5	200	500	—	ns
SH Pulse Rise Time, Fall Time	t2, t4	0	50	—	ns
SH Pulse Width	t3	1000	1500	—	ns
ϕ 2B Pulse Rise Time, Fall Time	t6, t7	0	100	—	ns
RS Pulse Rise Time, Fall Time	t8, t10	0	20	—	ns
RS Pulse Width	t9	10	100	—	ns
Video Data Delay Time (Note 13)	t11	—	10	—	ns
CP Pulse Rise Time, Fall Time	t12, t14	0	20	—	ns
CP Pulse Width	t13	10	100	—	ns
Pulse Timing of ϕ 2B and CP	t15	0	50	—	ns
Pulse Timing of RS and CP	t16	0	100	—	ns
	t17	10	100	—	
Pulse Timing of SH and CP	t18	200	—	—	ns
Pulse Timing of SH and RS	t19	200	—	—	ns

Note 12: TYP. is the case of $f_{RS}=1.0\text{MHz}$

Note 13: Load Resistance is $100\text{k}\Omega$

CAUTION**1. Window Glass**

The dust and stain on the glass window of the package degrade optical performance of CCD sensor.

Keep the glass window clean by saturating a cotton swab in alcohol and lightly wiping the surface, and allow the glass to dry, by blowing with filtered dry N₂. Care should be taken to avoid mechanical or thermal shock because the glass window is easily to damage.

2. Electrostatic Breakdown

Store in shorting clip or in conductive foam to avoid electrostatic breakdown.

CCD Image Sensor is protected against static electricity, but interior puncture mode device due to static electricity is sometimes detected. In handling the device, it is necessary to execute the following static electricity preventive measures, in order to prevent the trouble rate increase of the manufacturing system due to static electricity.

- a. Prevent the generation of static electricity due to friction by making the work with bare hands or by putting on cotton gloves and non-charging working clothes.
- b. Discharge the static electricity by providing earth plate or earth wire on the floor, door or stand of the work room.
- c. Ground the tools such as soldering iron, radio cutting pliers or pincer.

It is not necessarily required to execute all precaution items for static electricity.

It is all right to mitigate the precautions by confirming that the trouble rate within the prescribed range.

3. Incident Light

CCD sensor is sensitive to infrared light. Note that infrared light component degrades resolution and PRNU of CCD sensor.

4. Soldering

Soldering by the solder flow method cannot be guaranteed because this method may have deleterious effects on prevention of window glass soiling and heat resistance.

Using a soldering iron, complete soldering within ten seconds for lead temperatures of up to 260°C, or within three seconds for lead temperatures of up to 350°C.

PACKAGE DIMENSIONS

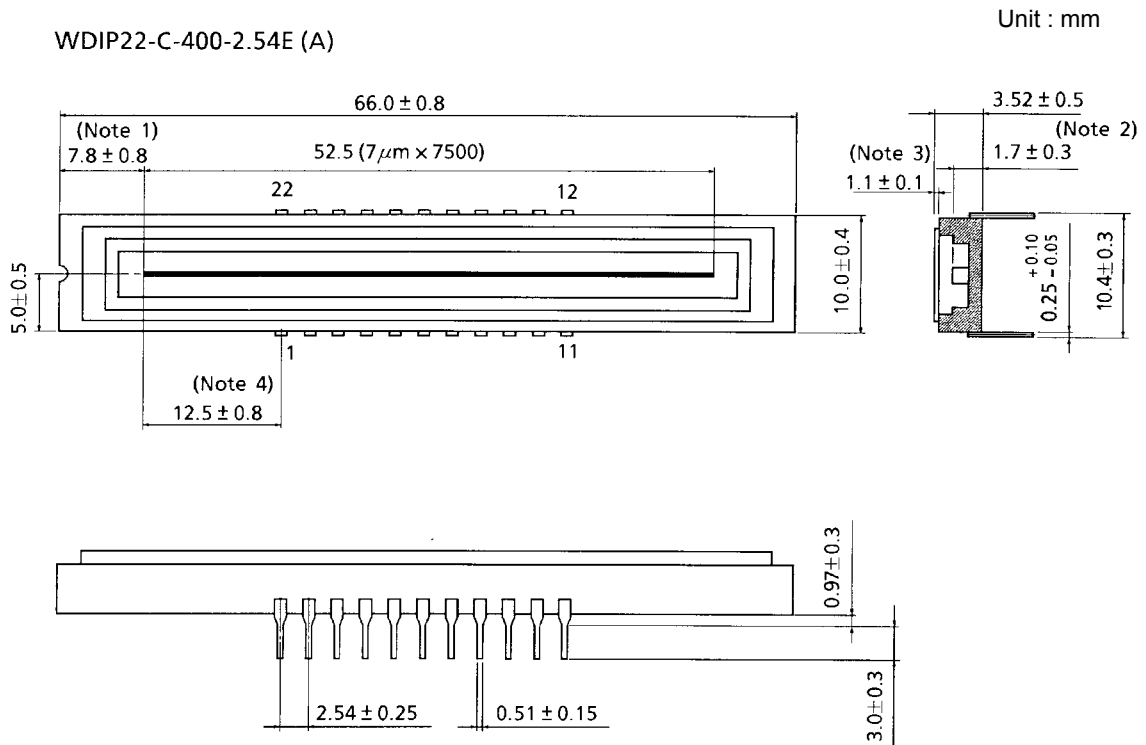

- Note 1: No. 1 SENSOR ELEMENT (S1) TO EDGE OF PACKAGE.
- Note 2: TOP OF CHIP TO BOTTOM OF PACKAGE.
- Note 3: GLASS THICKNES (n=1.5)
- Note 4: No. 1 SENSOR ELEMENT (S1) TO CENTER OF No. 1 PIN.

Weight : 6.6g (Typ.)

RESTRICTIONS ON PRODUCT USE

000707EBA

- TOSHIBA is continually working to improve the quality and reliability of its products. Nevertheless, semiconductor devices in general can malfunction or fail due to their inherent electrical sensitivity and vulnerability to physical stress. It is the responsibility of the buyer, when utilizing TOSHIBA products, to comply with the standards of safety in making a safe design for the entire system, and to avoid situations in which a malfunction or failure of such TOSHIBA products could cause loss of human life, bodily injury or damage to property.
In developing your designs, please ensure that TOSHIBA products are used within specified operating ranges as set forth in the most recent TOSHIBA products specifications. Also, please keep in mind the precautions and conditions set forth in the "Handling Guide for Semiconductor Devices," or "TOSHIBA Semiconductor Reliability Handbook" etc..
- The TOSHIBA products listed in this document are intended for usage in general electronics applications (computer, personal equipment, office equipment, measuring equipment, industrial robotics, domestic appliances, etc.). These TOSHIBA products are neither intended nor warranted for usage in equipment that requires extraordinarily high quality and/or reliability or a malfunction or failure of which may cause loss of human life or bodily injury ("Unintended Usage"). Unintended Usage include atomic energy control instruments, airplane or spaceship instruments, transportation instruments, traffic signal instruments, combustion control instruments, medical instruments, all types of safety devices, etc.. Unintended Usage of TOSHIBA products listed in this document shall be made at the customer's own risk.
- The products described in this document are subject to the foreign exchange and foreign trade laws.
- The information contained herein is presented only as a guide for the applications of our products. No responsibility is assumed by TOSHIBA CORPORATION for any infringements of intellectual property or other rights of the third parties which may result from its use. No license is granted by implication or otherwise under any intellectual property or other rights of TOSHIBA CORPORATION or others.
- The information contained herein is subject to change without notice.