



## Kotron® RF Sensing Probes

### DESCRIPTION

---

Kotron RF Capacitance sensing probes are available in many different configurations to handle a wide variety of application conditions.

The sensing probes in this brochure can be combined with Kotron level switches and transmitters.

### FEATURES

---

#### RIGID PROBES

- Available as bare probe or insulated probe
- Maximum process temperature:
  - +1000° F (+540° C) – bare probe
  - +400° F (+200° C) – insulated probe
- Maximum process pressure 5,000 PSIG (345 bar)
- Lengths up to 234 inches (6 meters)
- Bare probes can be cut to length in the field
- Wetted materials include 316/316L SS, Hastelloy® C, Teflon® (TFE), Halar® (ECTFE) and Kynar® (PVDF)
- Ceramic seals for High Temperature/High Pressure designs

#### FLEXIBLE PROBES

- Available as bare probe or insulated probe
- Maximum temperature:
  - +650° F (+345° C) – bare probe
  - +285° F (+140° C) – insulated probe
- Lengths up to 150 feet (45 meters)
- Insulated probe length can be adjusted in the field
- Wetted materials include 316 SS and Halar® (ECTFE)
- Teflon® seals for standard probes
- Ceramic seals for High Temperature/High Pressure designs



### TECHNOLOGY

---

The amount of capacitance developed in any application is affected by three variables:

- size (surface area) of the probe;
- distance from the probe to its ground;
- dielectric of the medium it is measuring.

Considering that the probe's mounting position is fixed, and the dielectric constant of the process media is stable, then the amount of capacitance developed is directly proportional to the level of the process media on the probe. Increasing the surface area (diameter) of the probe and/or decreasing the distance between the probe and its ground reference will increase the capacitance gain.

### APPLICATIONS

---

- Clean or dirty liquids
- Viscous liquids
- Light slurries
- High temperature/pressure liquids
- Foods and beverages
- Hydrocarbons and solvents
- Corrosives, acids, and caustics

# MAGNESEAL® PROBES

Probes are an essential component of the RF Capacitance measurement system. They are critical in development of the proper “capacitor” for reliable level measurement. As importantly, the probe becomes part of the process seal of the vessel; its reliability is crucial. With the development of the Magneseal probe, Magnetrol has taken strides to further ensure this reliability.

The Magneseal probe offers the following advantages:

1. A sophisticated compression seal exerts radial pressure between the center rod and the mounting nut yielding bulletproof sealing up to 3000 psig (205 bar).
2. Spring washers maintain the seal particularly during varying temperature and pressure that can degrade other process seals.

3. The Teflon® (TFE) probe insulation is heat-treated which forms the material tight to the probe rod. This process yields better linearity and eliminates “stress-relieving” (elongation) of the material at elevated temperatures.
4. Stability of the outer jacket is maintained by the end of the probe barb which further secures the insulating jacket.

The Magneseal design ensures reliability long after initial installation.

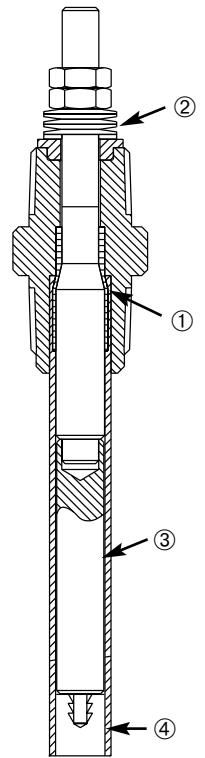

# PROCESS MEDIA GUIDELINES

**Non-conductive** (dielectric less than 10 or conductivity less than 10  $\mu$ siemens/cm)

Hydrocarbons, solvents, and bulk solids typically fall into the category of non-conductive media. Initially, when the vessel is empty, the dielectric constant is 1 (air). As the media level rises, the dielectric of the media replaces the air, thus causing the capacitance to increase. This increase is linear with the level increase. A bare probe is usually the best choice for this application.

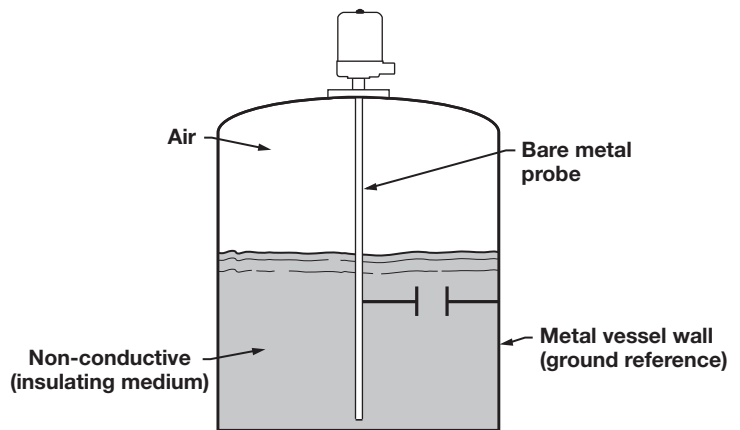

**Conductive** (dielectric greater than 10 or conductivity greater than 10  $\mu$ siemens/cm)

Conductive media in conjunction with a bare probe will result in an electrical “short”, causing a transmitter to indicate a high level or a switch to change state. The solution is to use an insulated probe constructed of Teflon®, Kynar®, or Halar®. The conductive media creates an electrical connection between a metal vessel wall and the probe insulation. Like the non-conductive application, the distance between the probe and ground, and the probe diameter is fixed. Instead of measuring the dielectric of the media, we are measuring the dielectric of the probe insulation which is covered by the media.

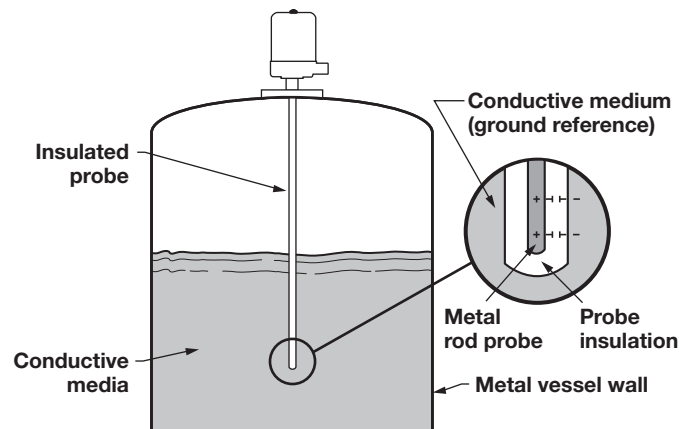

# PROBE SELECTION

Probe selection is the most critical part of applying an RF Capacitance device for a given application. The goal is to select the probe that will give the optimum capacitance change per unit level change (pF/inch). The first step in selecting an RF probe is determining the correct configuration for your application. The following guidelines will assist you in this selection.

1. Use bare probes for non-conductive liquids.
2. Use insulated probes for conductive liquids. If you are uncertain about the conductivity value, use an insulated probe. Teflon® has the widest temperature range and material compatibility. Kynar® will maximize the capacitance change.
3. Use a probe with an integral ground reference (Reference Probe) when measuring non-conductive fluids in horizontal vessels, non-conductive liquids

where the probe will be mounted more than 12" (30 cm) from the vessel wall, or when measuring any liquid in non-metallic vessels. The stillwell probe is the most common. If the application requires "no metal" in the process; or, if the liquid is too viscous for a stillwell, use the reference rod probe. The reference wire probe should only be used in clean, conductive, non-coating applications.

4. Use a flexible (cable) probe when the measurement range is greater than 10 feet (3 meters). Rigid (rod) probes are available up to 234 inches (6 meters) in length, but they are sometimes difficult to handle and can be damaged during installation.
5. Use an inactive sheath probe when mounting horizontally through a nozzle.

## RIGID PROBES

Rigid probes consist of a process connection, probe rod, and the seal. The rod may take many forms, depending on the application. The following is a description of some of the more common rigid probe styles:

### Bare probes

Bare rod probes are typically used in non-conductive process media with a dielectric value less than 10 or a conductivity value less than 10  $\mu$ siemens/in. Capacitance is measured from the probe through the process media to the vessel wall.

### Insulated probes

Insulated rod probes are used in conductive process media with a dielectric value greater than 10 or a conductivity value greater than 10  $\mu$ siemens/in. Capacitance is typically measured from the probe rod through the insulation to the process media, which is at the same potential as the vessel wall for conductive media. Probes are insulated with Teflon®, Halar®, or Kynar®. When you are uncertain about the dielectric constant of your process media, insulated probes are a wise choice.

### Inactive sheath probes

An inactive sheath is a metallic tube that is tightly coupled to the insulation on the probe rod and attached to the process connection. The sheath "deadens" the portion of the probe covered. It is used when a false capacitance could be developed by interference, such as:

- Collection of debris in a nozzle when the probe is horizontally mounted
- Falling process media entering the vessel
- Use with Retractable Probe Assembly (Hot Tap)

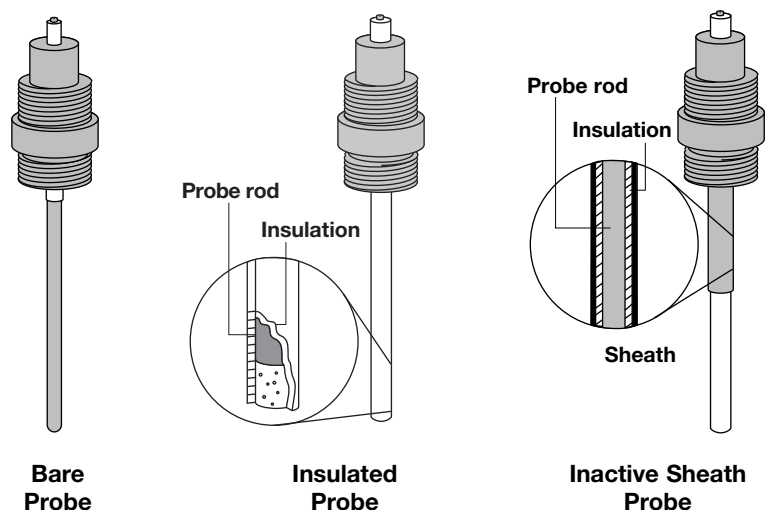

**Bent probes**

Bent rod probes have a variety of uses. They can provide vertical configurations when only side mounting is available. They can also provide horizontal configurations when only top mounting is available. When top mounted, the horizontal section of the probe can be used to create an extremely stable setpoint by developing a very large capacitance change with a small level change.

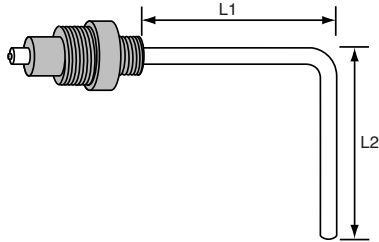

Sanitary fitting

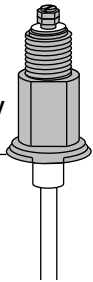

**Sanitary probes**

These probes consist of Teflon® (TFE) insulated rods with a Tri-clover style process connection and are certified by 3A.

**REFERENCE PROBES**

This classification covers probes that supply the “second plate of the capacitor” in non-metallic vessels, or linearize an existing reference (i.e. horizontal cylindrical vessels). There are *three* types of referenced probes offered:

**Stillwell probes**

A stillwell is a metallic tube into which a probe is inserted. It can be used to minimize the effect of turbulence in a vessel and increases the capacitance gain by bringing the ground reference closer to the probe. Stillwell probes are recommended for vessels with agitators.

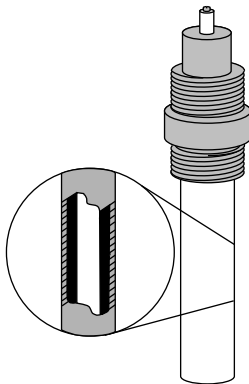

**Reference wire**

A reference wire is spirally wrapped around an insulated probe to provide a “ground” reference where none exists. It must be used selectively: clean, conductive, and low viscosity processes only.

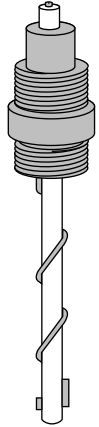

**Reference rod probes**

An insulated reference rod is mounted parallel with the sensing probe. It is typically used with corrosive process media in non-metallic vessels where no metal can be introduced to the process.

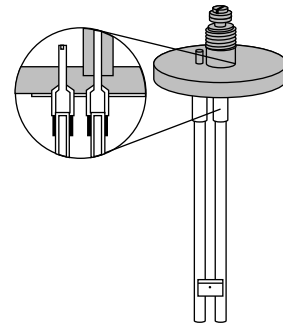

**GUARDED PROBES**

Guarded probes are only used for switch function in applications where buildup can occur. The guarded probes require additional coating rejection circuitry and can only be used with the following Kotron switches: Model 810, Model 811, and Sentinel Model 822.

The guarded probe can be cut to length but requires a minimum of 4 inches (100 mm) below the lower probe insulator.

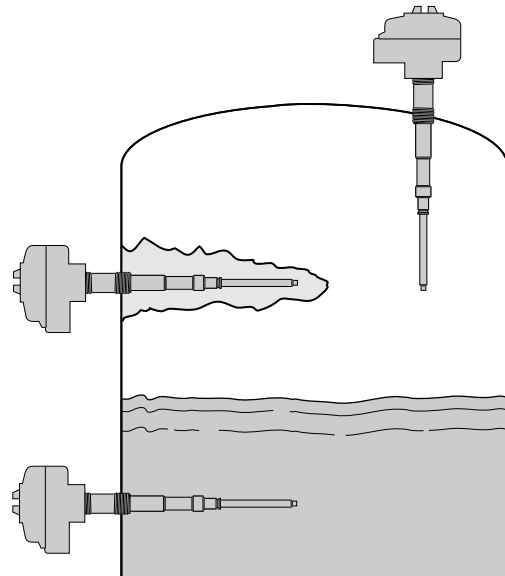

# FLEXIBLE PROBES

## Insulated flexible and bare flexible probes

Rigid probes longer than 10 feet (3 m) are difficult to install and to physically move in the field. Flexible probes are the ideal solution for measuring ranges from 10 feet (3 m) up to 150 feet (45 m).

Insulated flexible probes can be used with either conductive or non-conductive media. Bare flexible probes can only be used with non-conductive media.

Always verify that the selected electronics is powerful enough to operate at these longer distances.

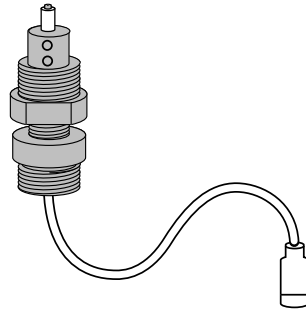

# HEAT EXTENSION

## HEAT DISSIPATION GRAPH

For use with Heat extension (89-6593-001)

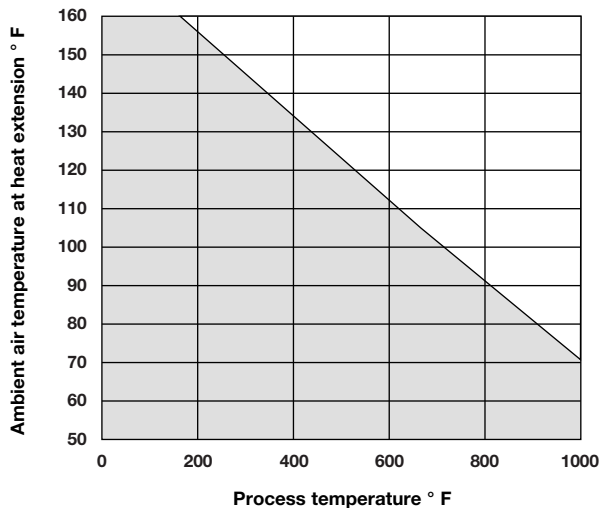

The heat dissipation graph, at left, depicts the maximum temperatures at which the extension can be used effectively.

1. Determine the maximum process temperature in the application and locate on X axis.
2. Determine the maximum ambient temperature surrounding the heat extension and locate on the Y axis.
3. If the intersecting point on the graph is within the shaded area the heat extension will dissipate enough heat to keep the electronics temperature below +160° F (+70° C).

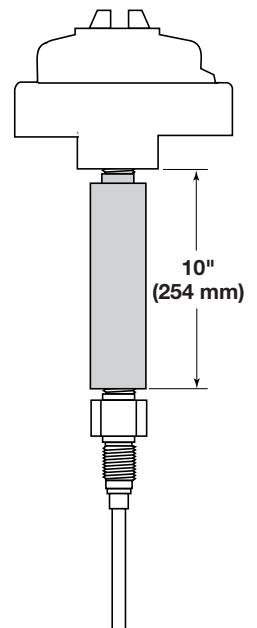

NOTE: The heat extension may be used with all rigid probe configurations and flexible probe configuration 8A2-AA1A-0XX. The heat extension can not be used with guarded probes.

# CAPACITANCE PICOFARAD (PF)

## GAIN GRAPHS

The following pages contain capacitance gain graphs which can be used to determine the proper probe/electronics choice for any given application. To use the graphs, follow the steps below.

1. Determine the dielectric of the process medium being measured. If the dielectric is unknown, use a dielectric of 2 for non-conductive media such as hydrocarbons or dry media, and a dielectric value of 80 for water based, conductive liquids (dielectric values are along the X axis).
2. Choose a probe. Because more than one probe will usually work, consider the other application parameters such as temperature, pressure, material compatibility, etc.
3. Find the graph which covers the chosen probe. Choose the curve on the graph which most closely relates to your particular application.
4. Using the chosen curve, determine the amount of pF/inch or pF/centimeter your application will develop (values are on Y axis).
5. Multiply the pF/inch value by the transmitter span needed in the application.
6. Compare total capacitance generated by the probe against the needed zero and span of the Kotron electronics to be used.

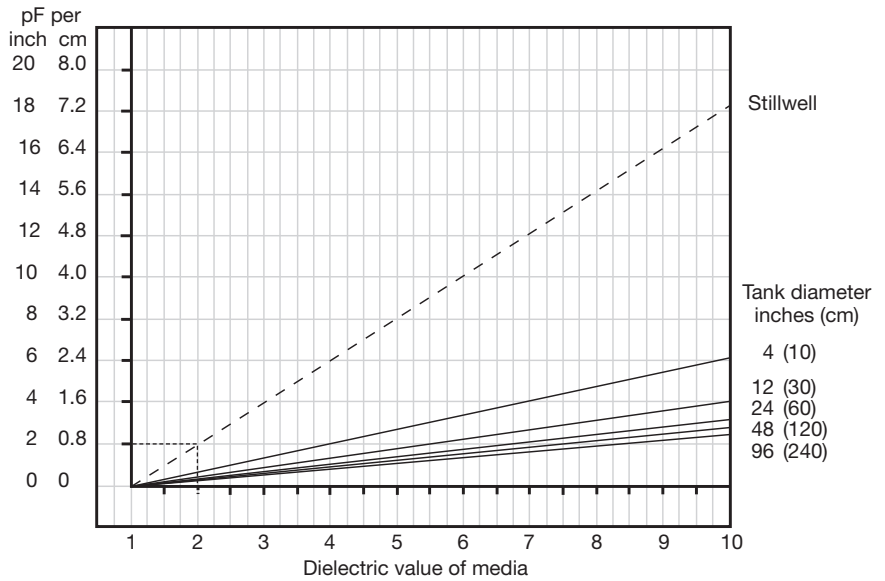

**Example:**

- Parameters:
- a. Dielectric = 2.0
  - b. Probe = Part No. 8AB-AA2B-072 (with stillwell)
  - c. pF/inch = 2.00
  - d. Electronics = Kotron Two-Wire Transmitter
  - e. Required application span = 72 in.
  - f. Electronics span = 50 pF min. to 4000 pF maximum (See chart below)

$2.00 \text{ pF/inch} \times 72 \text{ in} = 144 \text{ pF}$   
 The total capacitance is enough to meet the 50 pF minimum span of the electronics.

These charts are meant as an application aid; actual values may differ slightly. Always provide a 10% margin of error to ensure satisfactory performance.

These curves represent the probe located in the center of the vessel. If the probe is near one wall of a large vessel, multiply the distance from the vessel wall by 2 (to develop a diameter), choose the closest curve in the chart to your application, and then multiply the resultant pF value  $\times 78\%$ . This will account for the probe not being totally surrounded by the ground reference.

**RANGE OF CAPACITANCE ADJUSTMENT**

Level	Kotron Electronics	Zero set point	Span/Differential	
Point	Model 80-8032	0 to 350 pF	0.5 pF, fixed	
	Model 810	0 to 500 pF	0.5 pF, fixed	
	Model 811	0 to 1000 pF	0.5 pF to 700 pF	
	Models 80/81	Narrow	0 to 3000 pF	0.5 pF, fixed
		Wide High Range	0 to 3000 pF	4 to 1500 pF
		Wide Low Range	0 to 3000 pF	2 to 1500 pF
Models 822/832/842	0 to 50,000 pF	0.5 to 50,000 pF		
Continuous	Model 82CE	0 to 1000 pF	50 to 4000 pF	
	Model 804	0 to 50,000 pF	5 to 50,000 pF, 0.5 pF (setpoint min.)	
	Model 801	0 to 50,000 pF	5 to 50,000 pF, 0.5 pF (setpoint min.)	
	Model 805	0 to 10,000 pF	5 pF to 10,000 pF	

# CAPACITANCE PICOFARAD (PF) CONTINUED

## GAIN GRAPHS

### Capacitance gain for Teflon® and Halar® coated probes

8XA-1AXX-XXX or 8XA-4AXX-XXX  
8XA-2AXX-XXX or 8XA-5AXX-XXX

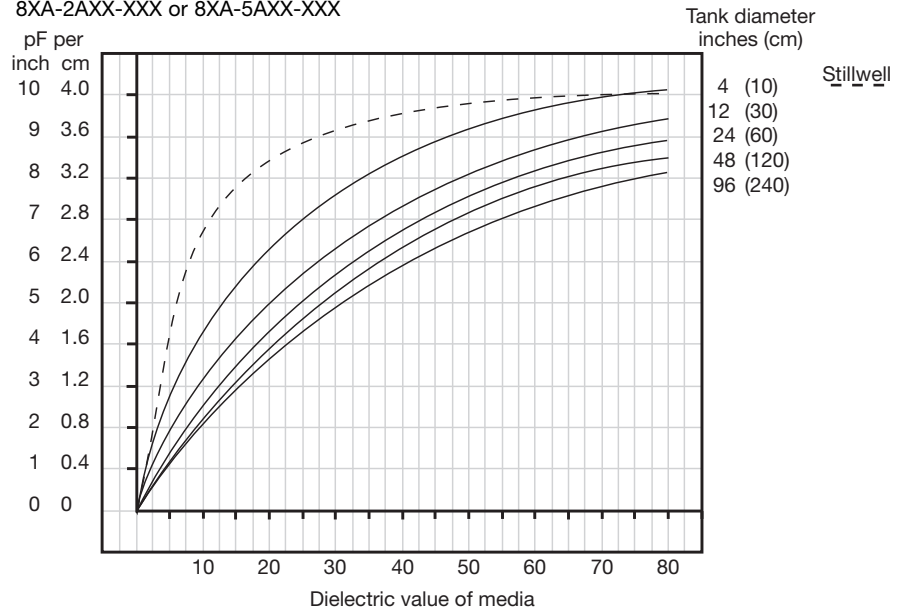

### Capacitance gain for Kynar® coated probes

8XA-3XXX-XXX or 8XA-6XXX-XXX

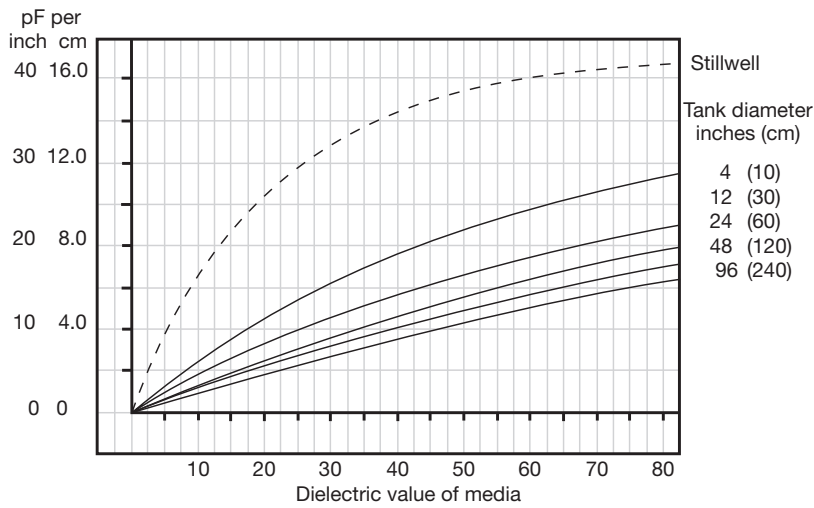

### Capacitance gain chart for bare probes

8XB-XXXX-XXX or 8XC-XXXX-XXX

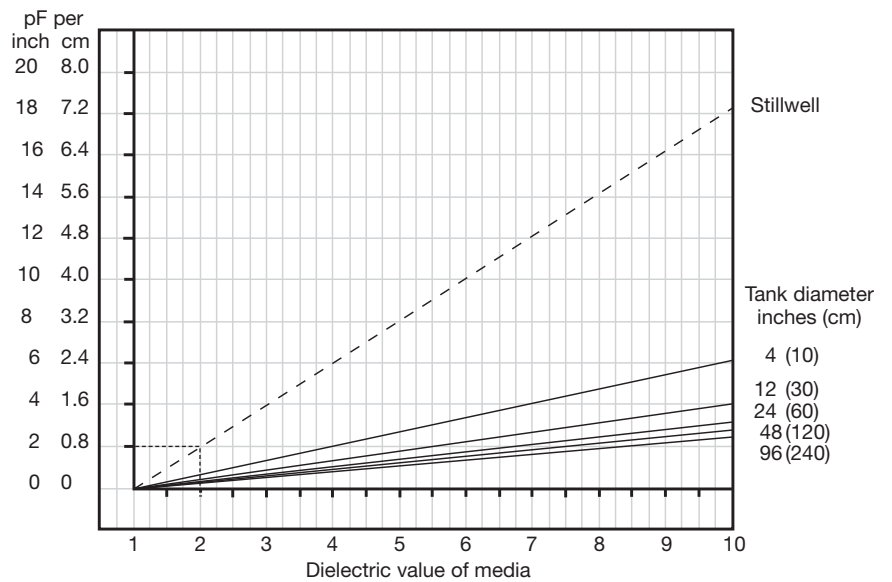

GAIN GRAPHS

**Capacitance gain chart for bare flexible probe**

8X2-AA1A-XXX 0.19" (5 mm) probe diameter

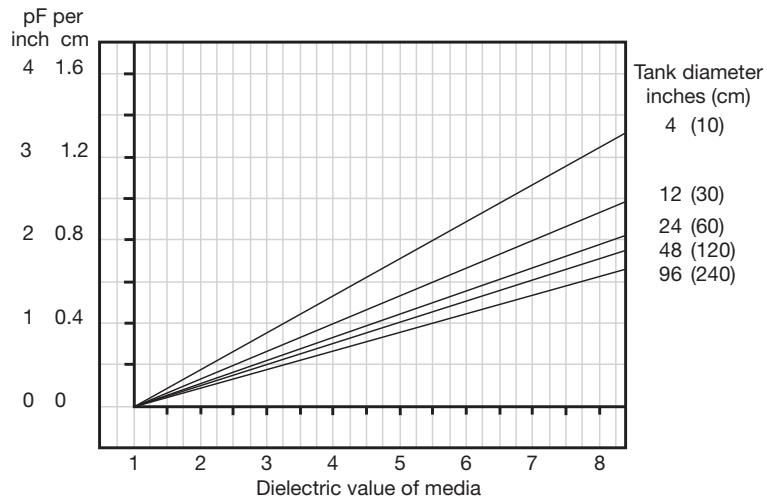

**Capacitance gain chart for standard flexible probe**

8X1-5A1A-XXX 0.19" (5 mm) probe diameter

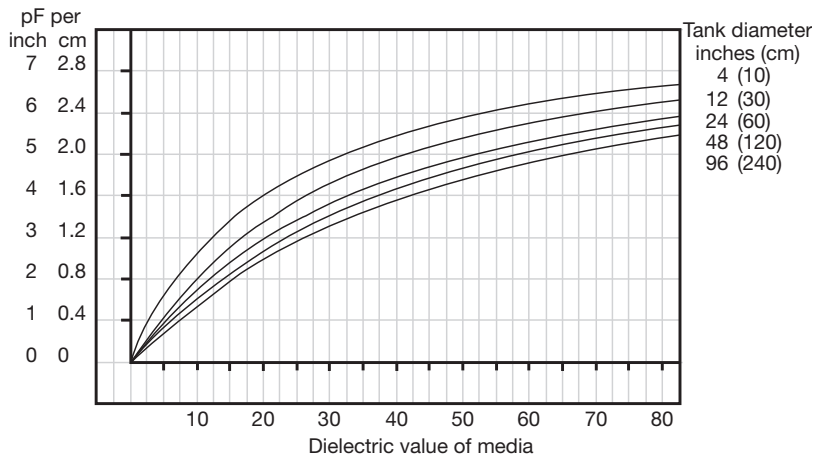



# PRESSURE TEMPERATURE CURVE

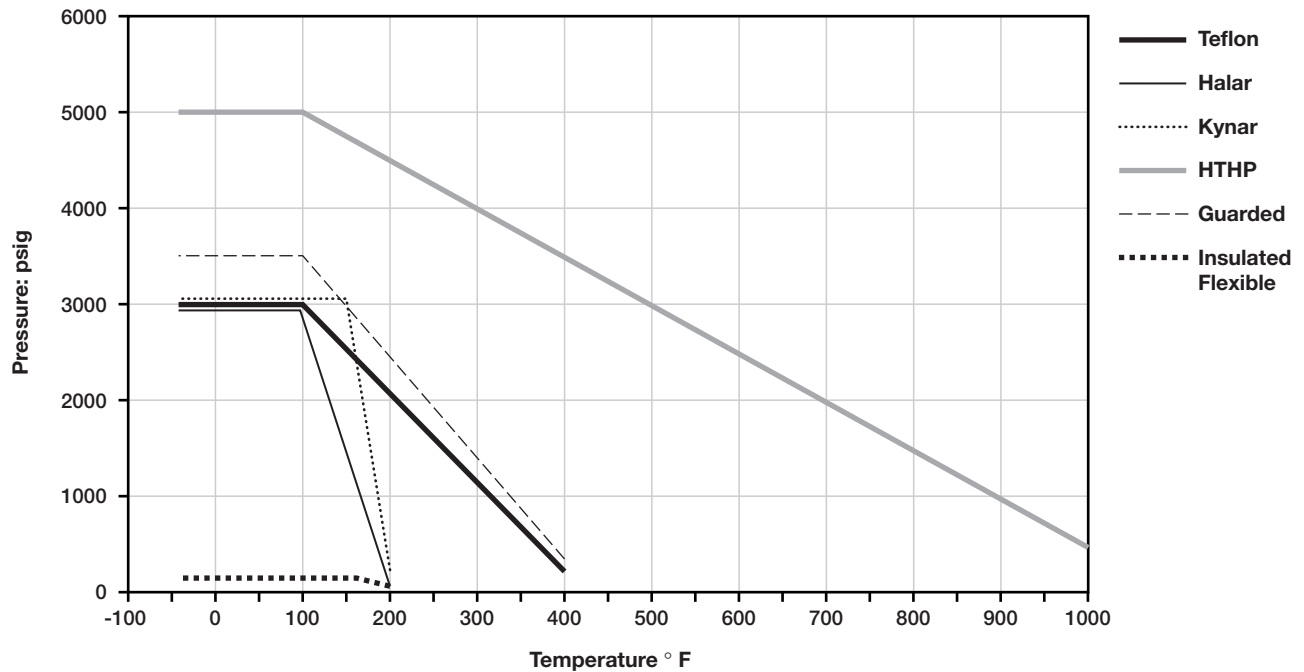

# PROBE QUICK SELECTION GUIDE

The most popular Kotron probes, handling the majority of applications, are outlined below. Rigid probe lengths are available in inches (second digit A) or centimeters (second digit C). Flexible probe lengths are available in feet (second digit A) or meters (second digit C).

Selection charts for all Kotron probes are located on pages 10 through 18.

Insulated rigid	¾" NPT, carbon steel rod, Teflon® insulation and seal	8AA-1A1A-XXX 8CA-1A1A-XXX
Bare rigid	¾" NPT, 316 stainless steel rod, Teflon® seal	8AB-AA1A-XXX 8CB-AA1A-XXX
Bare high temperature rigid	¾" NPT, 316 stainless steel rod, ceramic seal	8AC-AA1A-XXX 8CC-AA1A-XXX
Stillwell	1" NPT, carbon steel rod, 316 stainless steel stillwell, Teflon® insulation and seal	8AA-1A2B-XXX 8CA-1A2B-XXX
Reference wire rigid	¾" NPT, carbon steel rod, Teflon® insulation and seal	8AA-1A1E-XXX 8CA-1A1E-XXX
Bare flexible	¾" NPT, 316 stainless steel cable, ceramic seal	8A2-AA1A-XXX 8C2-AA1A-XXX
Insulated flexible	¾" NPT, 316 stainless steel cable, Halar® insulation and seal	8A1-5A1A-XXX 8C1-5A1A-XXX

# INSULATED RIGID PROBES

## MODEL NUMBER

Models available for quick shipment, usually within one week after factory receipt of a purchase order, through the Expedite Ship Plan (ESP).

### INSULATED RIGID PROBES

(for conductive or non conductive media)

A complete measuring system consists of a:

1. Kotron electronics (switch or transmitter)
2. Kotron probe
3. Optional heat extension for process temperatures >200° F (95° C): P/N 089-6593-001 (see page 5)

### BASIC MODEL NUMBER - INSULATED RIGID PROBE

8 A A	FM/CSA/ATEX, probe length in inches
8 C A	FM/CSA/ATEX, probe length in centimeters

### ROD, SEAL, AND INSULATION MATERIAL ① ② ③

1 A	Carbon steel rod with Teflon® (TFE) insulation max +400° F @ 200 psig/max 3000 psig @ +100° F (max +200° C @ 13.8 bar/max. 205 bar @ +40° C)
2 A	Carbon steel rod with Halar® (ECTFE) insulation max +200° F @ 50 psig/max 3000 psig @ +100° F (max +95° C @ 3.5 bar/max. 205 bar @ +40° C)
3 A	Carbon steel rod with Kynar® (PVDF) insulation max +200° F @ 200 psig/max 3000 psig @ +150° F (max +95° C @ 13.8 bar/max. 205 bar @ +65° C)
4 A	316/316L SS rod with Teflon® (TFE) insulation max +400° F @ 200 psig/max 3000 psig @ +100° F (max +200° C @ 13.8 bar/max. 205 bar @ +40° C)
5 A	316/316L SS rod with Halar® (ECTFE) insulation max +200° F @ 50 psig/max 3000 psig @ +100° F (max +95° C @ 3.5 bar/max. 205 bar @ +40° C)
6 A	316/316L SS rod with Kynar® (PVDF) insulation max +200° F @ 200 psig/max 3000 psig @ +150° F (max +95° C @ 13.8 bar/max. 205 bar @ +65° C)

① Temperature at electronics should not exceed 160° F (70° C).

② See pages 17 and 18 for other materials of construction.

③ Minimum temperature -40° F (-40° C)

### PROCESS CONNECTION - 316L SS (flange socket welded to probe)

1	¾" NPT (not available with Configuration Style code B)
2	1" NPT
E	G1 (1" BSP) thread
4	1" 150 lbs ANSI RF flange (not available with Configuration Style code B)
5	1½" 150 lbs ANSI RF flange
6	2" 150 lbs ANSI RF flange
7	3" 150 lbs ANSI RF flange
8	4" 150 lbs ANSI RF flange
9	1" 300 lbs ANSI RF flange (not available with Configuration Style code B)

Process connections continue on page 11.



# INSULATED RIGID PROBES

## MODEL NUMBER

### PROCESS CONNECTION - 316L SS (flange socket welded to probe)

A	1½" 300 lbs ANSI RF flange
B	2" 300 lbs ANSI RF flange
C	3" 300 lbs ANSI RF flange
D	4" 300 lbs ANSI RF flange
H	DN 25 PN 16 DIN 2527 Form B flange (not available with Configuration Style code B)
J	DN 40 PN 16 DIN 2527 Form B flange
K	DN 50 PN 16 DIN 2527 Form B flange
L	DN 25 PN 25/40 DIN 2527 Form B flange (not available with Configuration Style code B)
M	DN 40 PN 25/40 DIN 2527 Form B flange
N	DN 50 PN 25/40 DIN 2527 Form B flange
S	1/1½" Sanitary flange, 16 AMP-3A (available with Configuration Style code A and D only)
T	2" Sanitary flange, 16 AMP-3A (available with Configuration Style code A and D only)
U	3" Sanitary flange, 16 AMP-3A (available with Configuration Style code A and D only)
V	4" Sanitary flange, 16 AMP-3A (available with Configuration Style code A and D only)
Y	DN 25 Sanitary flange DIN 11851 (available with Configuration Style code A and D only)
Z	DN 50 Sanitary flange DIN 11851 (available with Configuration Style code A and D only)

### CONFIGURATION STYLE

A	Insulated rigid probe
B	Insulated rigid probe with 1" (25 mm) 316 SS diameter stillwell
C	Insulated rigid probe with 6" (15 cm) 316/316L SS inactive sheath
D	Insulated rigid bent probe 90° (specify L <sub>1</sub> and L <sub>2</sub> ) (Minimum L <sub>1</sub> length is 6.5 inches (16.5 cm); probe insertion length is L <sub>1</sub> + L <sub>2</sub> - 1")
E	Insulated rigid probe with 316/316L SS reference wire

### INSERTION LENGTH specify length in 1 inch (1 cm) increments (specify in digit 2)

6 to 234 inches (15 to 595 centimeters)

Example: 6 inches = 006 / 60 centimeters = 060

ESP available 6 to 234 inches in 1 inch increments ( 15 to 595 centimeters in 1 cm increment)





# HIGH TEMPERATURE / HIGH PRESSURE BARE RIGID PROBES

## MODEL NUMBER

A complete measuring system consists of a:

1. Kotron electronics (switch or transmitter)
2. Kotron probe
3. Optional heat extension for process temperatures >200° F (95° C): P/N 089-6593-001 (see page 5)

### BASIC MODEL NUMBER - HIGH TEMPERATURE/HIGH PRESSURE BARE PROBE

8 A C	FM/CSA/ATEX, probe length in inches ①
8 C C	FM/CSA/ATEX, probe length in centimeters ①

① Bare probes cannot be installed in a hazardous area unless used with an intrinsically safe electronic circuit.

### ROD AND SEAL MATERIAL ② ③ ④

A A	316 SS rod with ceramic seal max +1000° F @ 500 psig/max 5000 psig @ +100° F (max +535° C @ 35 bar/max. 345 bar @ +40° C)
-----	--

② Temperature at electronics should not exceed +160° F (+70° C).

③ See pages 17 and 18 for other materials of construction.

④ Minimum temperature -40° F (-40° C)

### PROCESS CONNECTION - 316L SS (flange socket welded to probe)

1	¾" NPT (not available with Configuration Style code B)
2	1" NPT
E	G1 (1" BSP) thread
4	1" 150 lbs ANSI RF flange (not available with Configuration Style code B)
5	1½" 150 lbs ANSI RF flange
6	2" 150 lbs ANSI RF flange
7	3" 150 lbs ANSI RF flange
8	4" 150 lbs ANSI RF flange
9	1" 300 lbs ANSI RF flange (not available with Configuration Style code B)
A	1½" 300 lbs ANSI RF flange
B	2" 300 lbs ANSI RF flange
C	3" 300 lbs ANSI RF flange
D	4" 300 lbs ANSI RF flange
H	DN 25 PN 16 DIN 2527 Form B flange (not available with Configuration Style code B)
J	DN 40 PN 16 DIN 2527 Form B flange
K	DN 50 PN 16 DIN 2527 Form B flange
L	DN 25 PN 25/40 DIN 2527 Form B flange (not available with Configuration Style code B)
M	DN 40 PN 25/40 DIN 2527 Form B flange
N	DN 50 PN 25/40 DIN 2527 Form B flange

### CONFIGURATION STYLE

A	High temperature/high pressure probe
B	High temperature/high pressure probe with 1" (25 mm) 316 SS diameter stillwell (1" process connection minimum)
D	High temperature/high pressure bent probe 90° (specify L <sub>1</sub> and L <sub>2</sub> ) (Minimum L <sub>1</sub> length is 10.5 inches (27 cm); probe insertion length is L <sub>1</sub> + L <sub>2</sub> - 1")

INSERTION LENGTH specify length in 1 inch (1 cm) increments (specify in digit 2)

6 to 234 inches (15 to 595 centimeters) Example: 6 inches = 006 / 60 centimeters = 060

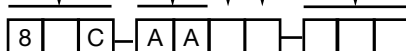

# GUARDED RIGID PROBES

## MODEL NUMBER

GUARDED RIGID PROBES (for use with 811 and 822 only)

A complete measuring system consists of a:

1. Kotron electronics
2. Kotron probe

### BASIC MODEL NUMBER

8 A D	FM/CSA, probe length in inches
8 C D	FM/CSA, probe length in centimeters

### ROD, SEAL, AND INSULATION MATERIAL ① ②

A A	316/316L SS rod with Ryton® guard insulation max +400° F @ 250 psig/max 3500 psig @ +100° F (max +200° C @ 17 bar/max 240 bar @ +40° C)
-----	--

① Temperature at electronics should not exceed +160° F (+70° C).

② Minimum temperature -40° F (-40° C)

### PROCESS CONNECTION, 316/316L SS

1	¾" NPT
E	G1 (1" BSP) thread

### CONFIGURATION STYLE

A	316 SS guarded probe
---	----------------------

### INSERTION LENGTH (specify in digit 2)

0 1 8	18" for ¾" NPT - 19" for G1 (1" BSP) thread
0 3 6	36" for ¾" NPT - 37" for G1 (1" BSP) thread
0 4 5	45 cm for ¾" NPT - 48 cm for G1 (1" BSP) thread
0 9 2	92 cm for ¾" NPT - 95 cm for G1 (1" BSP) thread



# INSULATED FLEXIBLE PROBES

## MODEL NUMBER

Models available for quick shipment, usually within one week after factory receipt of a purchase order, through the Expedite Ship Plan (ESP).

INSULATED FLEXIBLE PROBES  
(for conductive and non conductive media)

A complete measuring system consists of a:

1. Kotron electronics (switch or transmitter)
2. Kotron probe
3. Optional 316 SS Anchor assembly: P/N 032-8814-001  
 316 SS Weight: P/N 004-4355-001  
 Kynar® Insulated Weight: P/N 032-8902-001

### BASIC MODEL NUMBER - INSULATED FLEXIBLE PROBE ① ②

8 A 1	FM/CSA/ATEX, insulated flexible probe, probe length in feet
8 C 1	FM/CSA/ATEX, insulated flexible probe, probe length in meters

① Flexible probes cannot be installed in a hazardous area unless used with an intrinsically safe electronic circuit.

② Minimum temperature -40° F (-40° C)

### CABLE AND SEAL MATERIAL ③

5 A	316 SS cable with Halar® (ECTFE) insulation max +200° F @ 50 psig/max 100 psig @ +160° F (max +95° C @ 3.8 bar/max 7 bar @ +70° C)
-----	---

③ Temperature at electronics should not exceed +160° F (+70° C).

### PROCESS CONNECTION, 316 SS

1	3/4" NPT
---	----------

Threaded flanges may be ordered separately.

### CONFIGURATION STYLE

A	Insulated flexible probe
---	--------------------------

INSERTION LENGTH specify length in 1 foot (1 meter) increments (specify in digit 2)

10 to 150 feet (3 to 45 meters) Example: 10 feet = 010 / 3 meters = 003

ESP available 10 to 150 feet in 1 foot increments (3 to 45 meters in 1 meter increments)



# BARE FLEXIBLE PROBES

## MODEL NUMBER

BARE FLEXIBLE PROBES (for conductive and non conductive media)

A complete measuring system consists of a:

1. Kotron electronics (switch or transmitter)
2. Kotron probe
3. Optional heat extension for process temperatures >200° F (95° C): P/N 089-6593-001 (see page 5)

### BASIC MODEL NUMBER - BARE FLEXIBLE PROBE ① ②

8 A 2	FM/CSA/ATEX, bare flexible probe, probe length in feet
8 C 2	FM/CSA/ATEX, bare flexible probe, probe length in meters

- ① Bare probes cannot be installed in a hazardous area unless used with an intrinsically safe electronic circuit.  
 ② Minimum temperature -40° F (-40° C)

#### CABLE AND SEAL MATERIAL ③

A A	316 SS cable, ceramic seal max +1000° F @ 500 psig/max 5000 psig @ +100° F (max +535° C @ 35 bar/max 345 bar @ +40° C)
-----	---

- ③ Temperature at electronics should not exceed +160° F (+70° C).

#### PROCESS CONNECTION, 316 SS ④

1	¾" NPT
---	--------

- ④ Threaded flanges may be ordered separately.

#### CONFIGURATION STYLE

A	Bare flexible probe
---	---------------------

#### INSERTION LENGTH specify length in 1 foot (1 meter) increments (specify in digit 2)

10 to 150 feet (3 to 45 meters) Example: 10 feet = 010 / 3 meters = 003

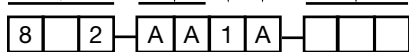

# SPECIALTY PROBES

## MODEL NUMBER

### BASIC MODEL NUMBER - HASTELLOY® C PROBE ① ② ③ ④

8 A B - B B 1	FM/CSA/ATEX, bare rigid Hastelloy C probe with ¾" NPT process connection and Teflon seal, probe length in inches
8 C B - B B 1	FM/CSA/ATEX, bare rigid Hastelloy C probe with ¾" NPT process connection and Teflon seal, probe length in centimeters

- ① Bare probes cannot be installed in a hazardous area unless used with an intrinsically safe electronic circuit.  
 ② Temperature at electronics should not exceed +160° F (+70° C).  
 ③ Max +400° F @ 200 psig/max 3000 psig @ +100° F (max +200° C @ 13.8 bar/max 205 bar @ +40° C)  
 ④ Minimum temperature -40° F (-40° C)

#### CONFIGURATION STYLE

A	Standard probe
D	Bent probe 90° (specify L <sub>1</sub> and L <sub>2</sub> ) (Minimum L <sub>1</sub> length is 6.5 inches (16.5 cm); probe insertion length is L <sub>1</sub> + L <sub>2</sub> - 1")

#### INSERTION LENGTH specify length in 1 inch (1 cm) increments (specify in digit 2)

6 to 234 inches (15 to 595 centimeters) Example: 6 inches = 006 / 60 centimeters = 060

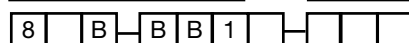



# SPECIALTY PROBES CONTINUED

## MODEL NUMBER

SPECIALTY PROBES (for conductive and non conductive media)

A complete measuring system consists of a:

1. Kotron electronics (switch or transmitter)
2. Kotron probe
3. Optional heat extension for process temperatures >200° F (95° C): P/N 089-6593-001 (see page 5)

### BASIC MODEL NUMBER - REFERENCE ROD PROBES ①

0 4 1 - 5 0	FM/CSA, length in inches
0 4 1 - 6 0	ATEX, length in centimeters

① Temperature at electronics should not exceed +160° F (+70° C).

### ROD MATERIAL, SEAL, AND PROCESS CONNECTION ②

7 8	Carbon steel rod with Halar® (ECTFE) insulation, 3" 150 lb carbon steel faced flange max +285° F @ 230 psig/max 285 psig @ +70° F (max +140° C @ 15.8 bar/max 20 bar @ +21° C)
-----	---

② Minimum temperature -40° F (-40° C)

### INSERTION LENGTH specify length in 1 inch (1 cm) increments (specify in digit 4)

6 to 234 inches (15 to 595 centimeters) Example: 6 inches = 006 / 60 centimeters = 060

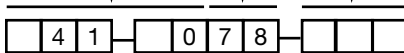

### BASIC MODEL NUMBER - PROBES WITH FACED FLANGE PROCESS CONNECTION ①

0 4 1 - 5 0	CSA, insulated rigid plastic probe, length in inches
0 4 1 - 6 0	ATEX, insulated rigid plastic probe, length in centimeters

① Temperature at electronics should not exceed +160° F (+70° C).

### ROD MATERIAL, SEAL, AND FLANGED PROCESS CONNECTION ②

6 0	Carbon steel rod with Halar® (ECTFE) insulation, 1½" 150 lb carbon steel flange with Halar® face ③
6 1	Carbon steel rod with Halar (ECTFE) insulation, 1½" 300 lb carbon steel flange with Halar face ④
6 2	Carbon steel rod with Halar (ECTFE) insulation, 2" 150 lb carbon steel flange with Halar face ③
6 3	Carbon steel rod with Halar (ECTFE) insulation, 2" 300 lb carbon steel flange with Halar face ④
6 4	Carbon steel rod with Halar (ECTFE) insulation, 3" 150 lb carbon steel flange with Halar face ③
6 5	Carbon steel rod with Halar (ECTFE) insulation, 3" 300 lb carbon steel flange with Halar face ④

### INSERTION LENGTH specify length in 1 inch (1 cm) increments (specify in digit 4)

6 to 234 inches (15 to 595 centimeters) Example: 6 inches = 006 / 60 centimeters = 060

② Minimum temperature -40° F (-40° C)

③ Max +285° F @ 250 psig/max 285 psig @ +100° F (max +140° C @ 17.2 bar/max 19.6 bar @ +38° C).

④ Max +285° F @ 300 psig/max 740 psig @ +100° F (max +140° C @ 20.7 bar/max 51 bar @ +38° C).

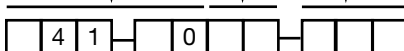

# SPECIALTY PROBES CONTINUED

## MODEL NUMBER

SPECIALTY PROBES (for conductive and non conductive media)

A complete measuring system consists of a:

1. Kotron electronics (switch or transmitter)
2. Kotron probe
3. Optional heat extension for process temperatures >200° F (95° C): P/N 089-6593-001 (see page 5)

### Basic Model Number - STILLWELL PROBE (316 SS PROCESS CONNECTION AND STILLWELL) ① ② ③

0 4 1 - 5 0 2 7	FM/CSA/ATEX, 3/8" NPT, carbon steel rod with TFE insulation, probe length in inches
0 4 1 - 6 0 2 7	FM/CSA/ATEX, 3/8" NPT, carbon steel rod with TFE insulation, probe length in centimeters

- ① Temperature at electronics should not exceed +160° F (+70° C).
- ② Max +300° F @ 500 psig/max 1000 psig @ +70° F (max +150° C @ 34.5 bar/max 70 bar @ +21.1° C)
- ③ Minimum temperature -40° F (-40° C)

INSERTION LENGTH specify length in 1 inch (1 cm) increments (specify in digit 4)

6 to 234 inches (15 to 595 centimeters) Example: 6 inches = 006 / 60 centimeters = 060

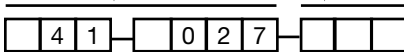

# DIMENSIONS

INCHES (MM)

## PROBES

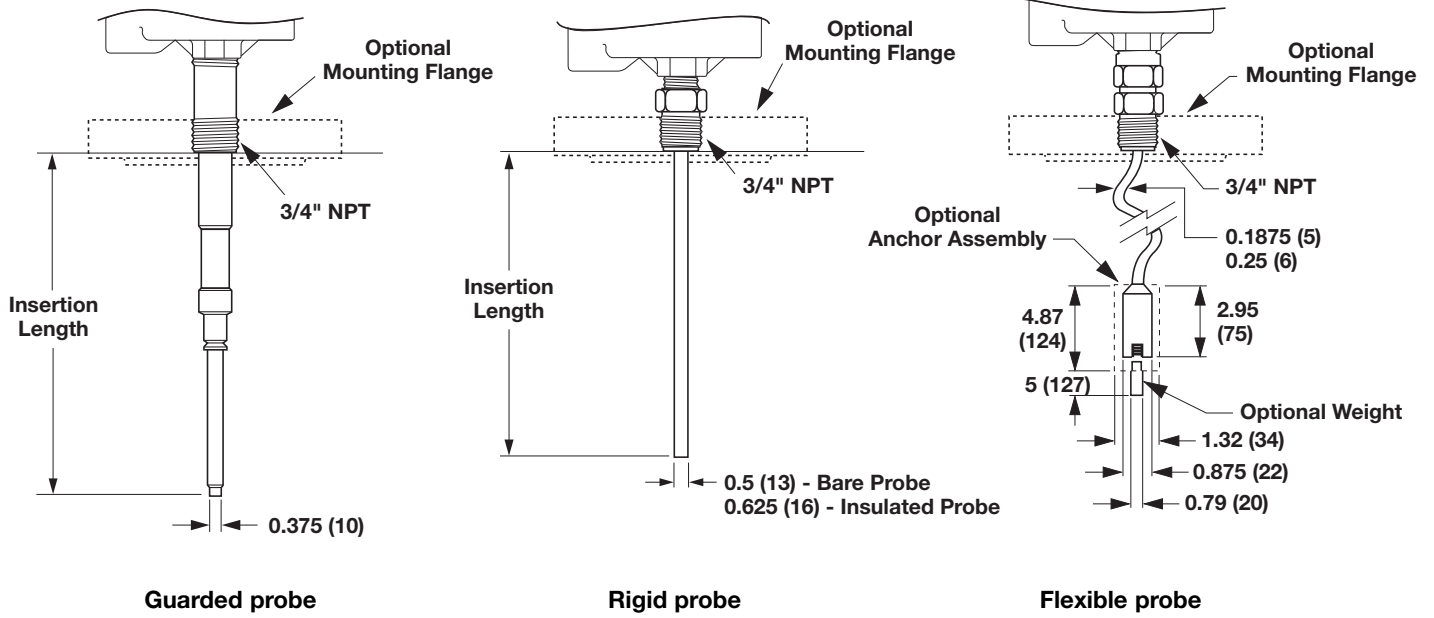

## CONNECTIONS

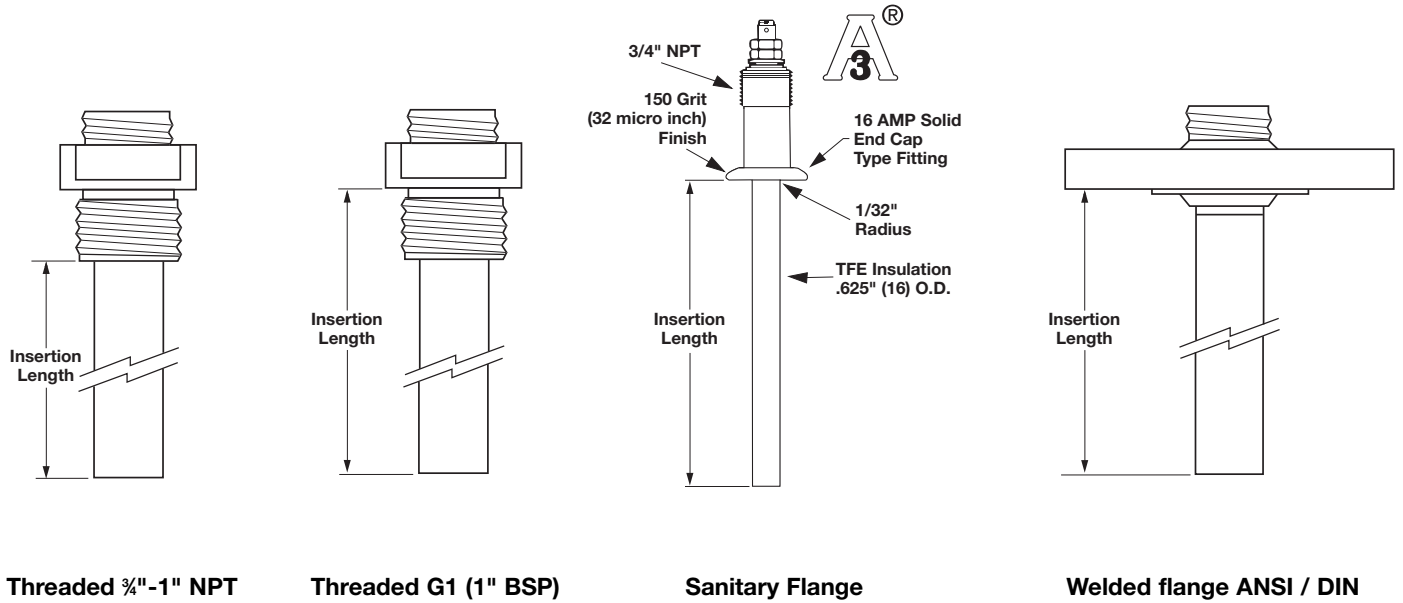

## QUALITY

---



The quality assurance system in place at Magnetrol guarantees the highest level of quality throughout the company. Magnetrol is committed to providing full customer satisfaction both in quality products and quality service.

Magnetrol's quality assurance system is registered to ISO 9001 affirming its commitment to known international quality standards providing the strongest assurance of product/service quality available.

## ESP

---

### Expedite Ship Plan

Several Kotron Sensing Probes are available for quick shipment, usually within one week after factory receipt of a purchase order, through the Expedite Ship Plan (ESP).

Models covered by ESP service are color coded in the selection data charts.

To take advantage of ESP, simply match the color coded model number codes (standard dimensions apply).

ESP service may not apply to orders of ten units or more. Contact your local representative for lead times on larger volume orders, as well as other products and options.

## WARRANTY

---



All Magnetrol electronic level and flow controls are warranted free of defects in materials or workmanship for one full year from the date of original factory shipment.

If returned within the warranty period; and, upon factory inspection of the control, the cause of the claim is determined to be covered under the warranty; then, Magnetrol will repair or replace the control at no cost

to the purchaser (or owner) other than transportation.

Magnetrol shall not be liable for misapplication, labor claims, direct or consequential damage or expense arising from the installation or use of equipment. There are no other warranties expressed or implied, except special written warranties covering some Magnetrol products.



5300 Belmont Road • Downers Grove, Illinois 60515-4499 • 630-969-4000 • Fax 630-969-9489 • www.magnetrol.com  
145 Jardin Drive, Units 1 & 2 • Concord, Ontario Canada L4K 1X7 • 905-738-9600 • Fax 905-738-1306  
Heikensstraat 6 • B 9240 Zele, Belgium • 052 45.11.11 • Fax 052 45.09.93  
Regent Business Ctr., Jubilee Rd. • Burgess Hill, Sussex RH15 9TL U.K. • 01444-871313 • Fax 01444-871317

Copyright © 2008 Magnetrol International, Incorporated. All rights reserved. Printed in the USA.  
Performance specifications are effective with date of issue and are subject to change without notice.

Magnetrol & Magnetrol logotype, Magnesal® and Kotron® are registered trademarks of Magnetrol International  
Hastelloy® is a registered trademark of Haynes International, Inc.  
Teflon® is a registered trademark of DuPont.  
Halar® is a registered trademark of Allied Chemical Corp.  
Kynar® is a registered trademark of Arkema, Inc.  
Ryton® is a registered trademark of Chevron Phillips Chemical Company

**BULLETIN: 50-125.13**  
**EFFECTIVE: November 2008**  
**SUPERSEDES: March 2004**