

LXA16T600C

Qspeed™ Family



600 V, 16 A X-Series Common-Cathode Diode

Product Summary

| | | |
|------------------------------------|------|----|
| $I_{F(AVG)}$ per diode | 8 | A |
| V_{RRM} | 600 | V |
| Q_{RR} (Typ at 125 °C) | 82 | nC |
| I_{RRM} (Typ at 125 °C) | 3.5 | A |
| Softness t_b/t_a (Typ at 125 °C) | 0.55 | |

Pin Assignment

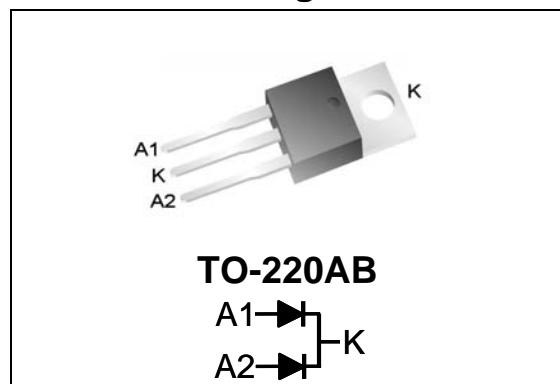

RoHS Compliant

Package uses Lead-free plating and Green mold compound.
Halogen free per IEC 61249-2-21.

General Description

This device has the lowest Q_{RR} of any 600V Silicon diode. Its recovery characteristics increase efficiency, reduce EMI and eliminate snubbers.

Applications

- Power Factor Correction (PFC) Boost Diode
- Motor drive circuits
- DC-AC inverters

Features

- Low Q_{RR} , Low I_{RRM} , Low t_{RR}
- High di_F/dt capable (1000A/ μ s)
- Soft recovery

Benefits

- Increases efficiency
 - Eliminates need for snubber circuits
 - Reduces EMI filter component size & count
- Enables extremely fast switching

Absolute Maximum Ratings

Absolute maximum ratings are the values beyond which the device may be damaged or have its useful life impaired. Functional operation under these conditions is not implied.

| Symbol | Parameter | Conditions | Rating | Units |
|--------------|-----------------------------------|---|------------|-------|
| V_{RRM} | Peak repetitive reverse voltage | | 600 | V |
| $I_{F(AVG)}$ | Average forward current | Per Diode, $T_J = 150\text{ °C}$, $T_C = 122\text{ °C}$ | 8 | A |
| | | Per Device, $T_J = 150\text{ °C}$, $T_C = 122\text{ °C}$ | 16 | A |
| I_{FSM} | Non-repetitive peak surge current | 60 Hz, ½ cycle | 60 | A |
| I_{FSM} | Non-repetitive peak surge current | ½ cycle of $t = 28\ \mu$ s Sinusoid, $T_C = 25\text{ °C}$ | 350 | A |
| T_J | Maximum junction temperature | | 150 | °C |
| T_{STG} | Storage temperature | | -55 to 150 | °C |
| | Lead soldering temperature | Leads at 1.6mm from case, 10 sec | 300 | °C |
| P_D | Power dissipation | $T_C = 25\text{ °C}$ | 83 | W |

Thermal Resistance

| Symbol | Resistance from: | Conditions | Rating | Units |
|-----------------|---------------------|------------|--------|-------|
| $R_{\theta JA}$ | Junction to ambient | TO-220AB | 62 | °C/W |
| $R_{\theta JC}$ | Junction to case | Per Diode | 1.5 | °C/W |
| | | Per Device | 0.8 | °C/W |

Electrical Specifications at $T_J = 25\text{ }^\circ\text{C}$ (unless otherwise specified)

| Symbol | Parameter | Conditions | Min | Typ | Max | Units | |
|--|---|---|-----------------------------------|------|------|---------------|----|
| DC Characteristics per diode | | | | | | | |
| I_R | Reverse current per diode | $V_R = 600\text{ V}, T_J = 25\text{ }^\circ\text{C}$ | - | - | 250 | μA | |
| | | $V_R = 600\text{ V}, T_J = 125\text{ }^\circ\text{C}$ | - | 0.85 | - | mA | |
| V_F | Forward voltage per diode | $I_F = 8\text{ A}, T_J = 25\text{ }^\circ\text{C}$ | - | 2.35 | 2.94 | V | |
| | | $I_F = 8\text{ A}, T_J = 150\text{ }^\circ\text{C}$ | - | 2.1 | - | V | |
| C_J | Junction capacitance per diode | $V_R = 10\text{ V}, 1\text{ MHz}$ | - | 40 | - | pF | |
| Dynamic Characteristics per diode | | | | | | | |
| t_{RR} | Reverse recovery time, per diode | $di_F/dt = 200\text{ A}/\mu\text{s}$ $V_R = 400, I_F = 8\text{ A}$ | $T_J = 25\text{ }^\circ\text{C}$ | - | 21.5 | - | ns |
| | | | $T_J = 125\text{ }^\circ\text{C}$ | - | 33 | - | ns |
| Q_{RR} | Reverse recovery charge, per diode | $di_F/dt = 200\text{ A}/\mu\text{s}$ $V_R = 400, I_F = 8\text{ A}$ | $T_J = 25\text{ }^\circ\text{C}$ | - | 31 | 48 | nC |
| | | | $T_J = 125\text{ }^\circ\text{C}$ | - | 82 | - | nC |
| I_{RRM} | Maximum reverse recovery current, per diode | $di_F/dt = 200\text{ A}/\mu\text{s}$ $V_R = 400, I_F = 8\text{ A}$ | $T_J = 25\text{ }^\circ\text{C}$ | - | 2.2 | 2.8 | A |
| | | | $T_J = 125\text{ }^\circ\text{C}$ | - | 3.5 | - | A |
| S | Softness per diode = $\frac{t_b}{t_a}$ | $di_F/dt = 200\text{ A}/\mu\text{s}$ $V_R = 400, I_F = 8\text{ A}$ | $T_J = 25\text{ }^\circ\text{C}$ | - | 0.74 | - | |
| | | | $T_J = 125\text{ }^\circ\text{C}$ | - | 0.55 | - | |

Note to component engineers: X-Series diodes employ Schottky technologies in their design and construction. Therefore, component engineers should plan their test setups to be similar to traditional Schottky test setups. (For further details, see application note AN-300.)

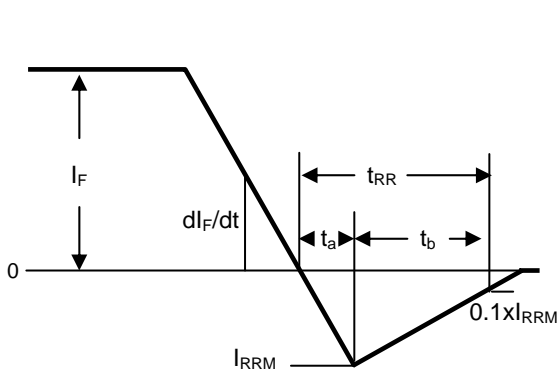

Figure 1. Reverse Recovery Definitions

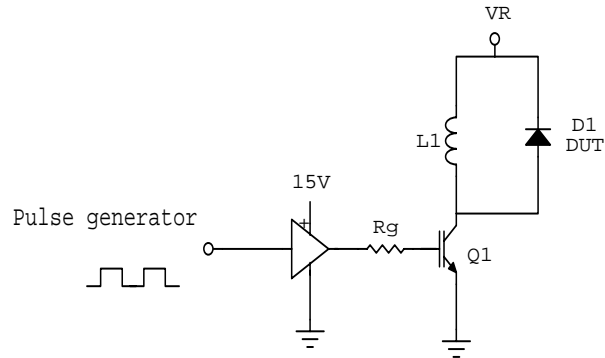

Figure 2. Reverse Recovery Test Circuit

Electrical Specifications at $T_J = 25\text{ }^\circ\text{C}$ (unless otherwise specified)

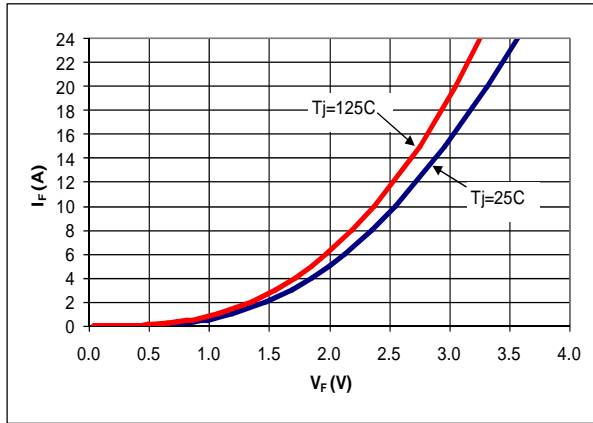

Figure 3. Typical I_F vs V_F

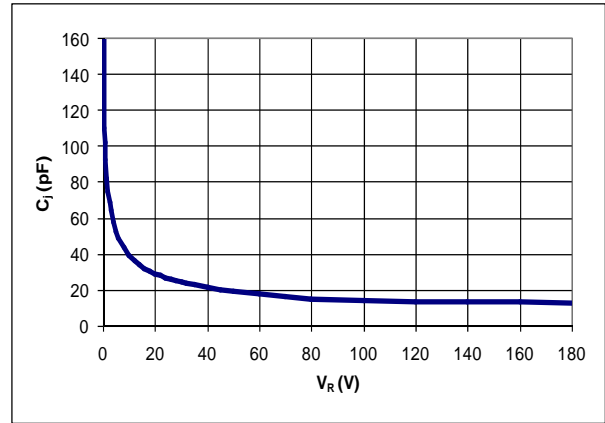

Figure 4. Typical C_i vs V_R

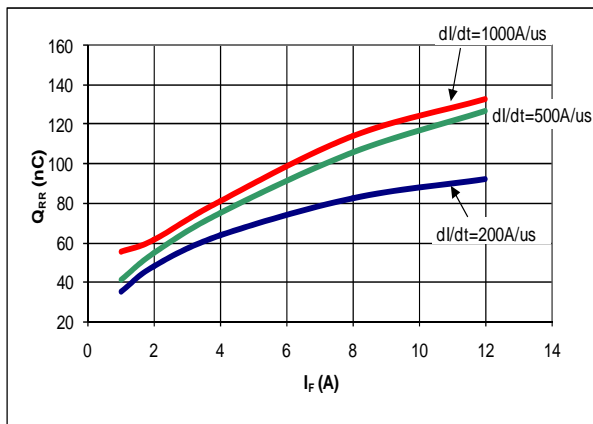

Figure 5. Typical Q_{RR} vs I_F at $T_J = 125\text{ }^\circ\text{C}$

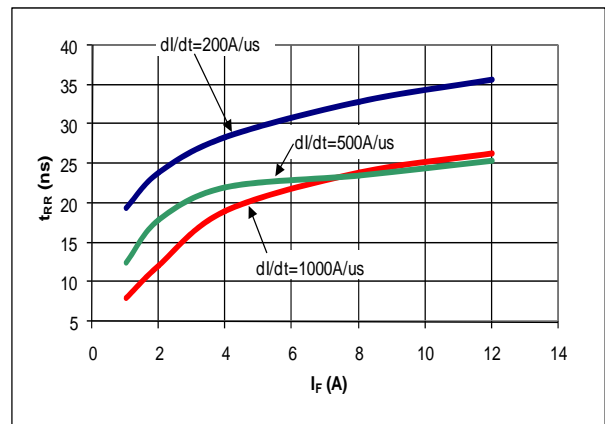

Figure 6. Typical t_{RR} vs I_F at $T_J = 125\text{ }^\circ\text{C}$

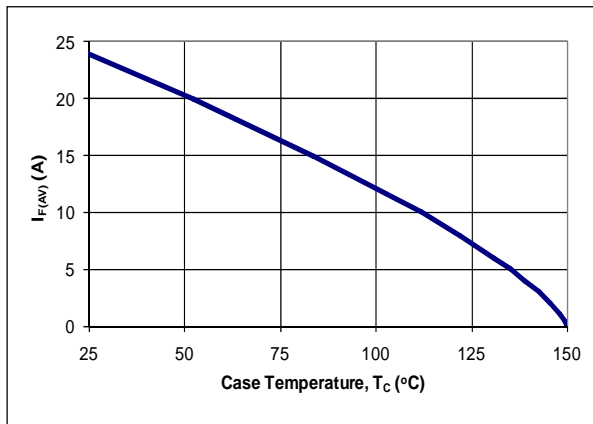

Figure 7. DC Current Derating Curve

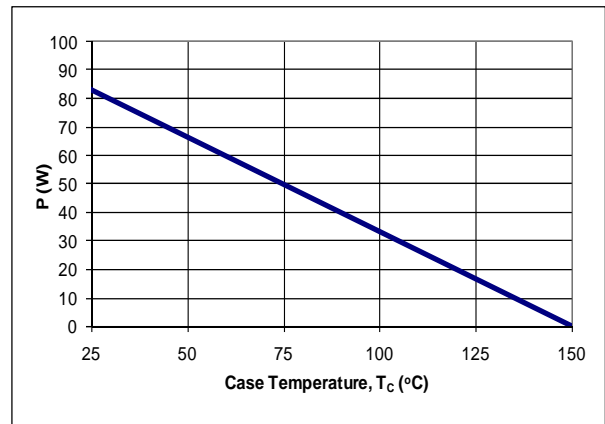

Figure 8. Power Derating Curve

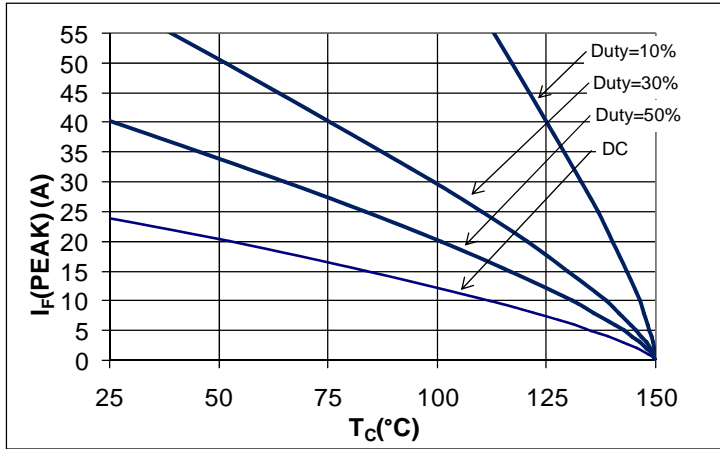

Figure 9. $I_f(\text{Peak})$ vs T_c , $f=70$ kHz

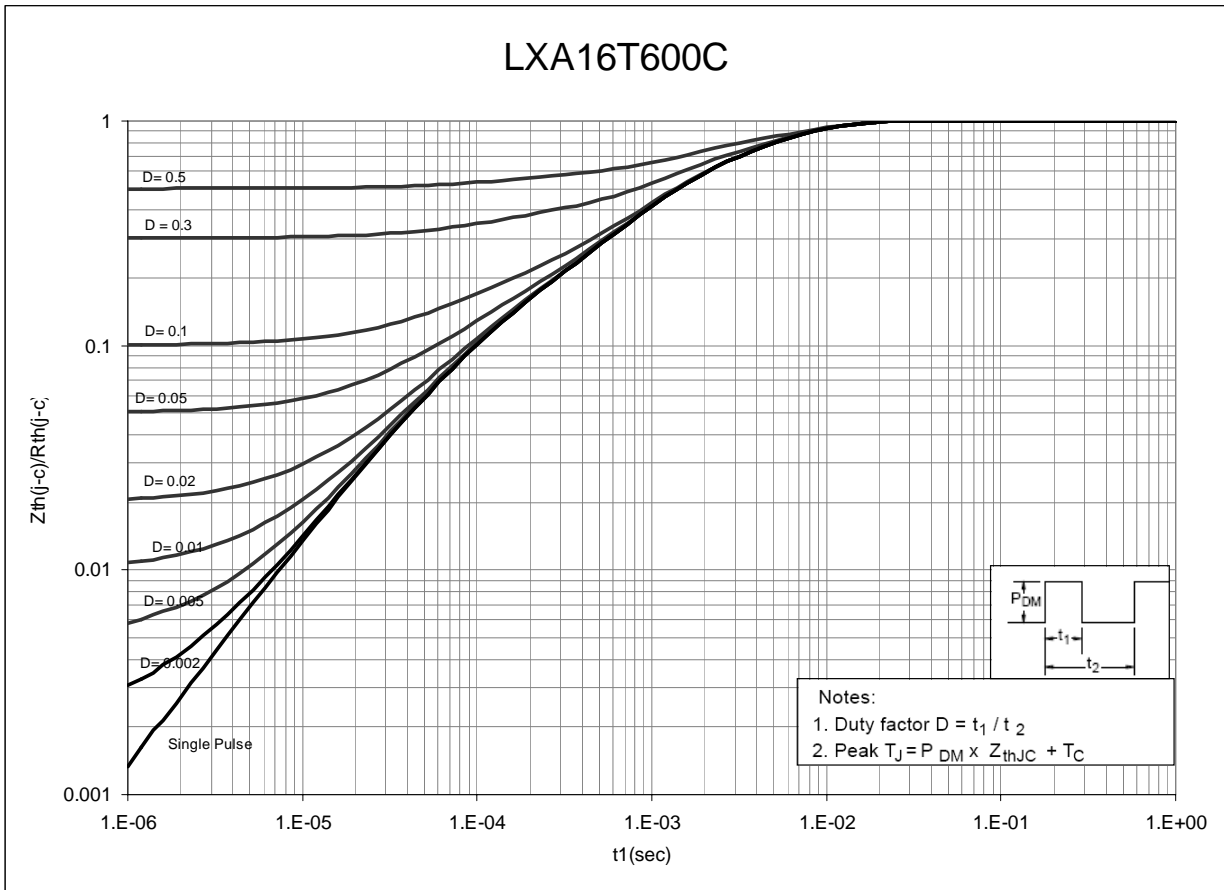
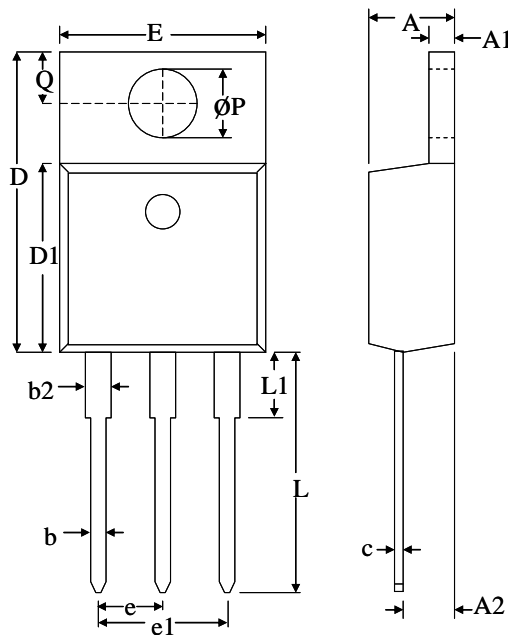

Figure 10. Normalized Maximum Transient Thermal Impedance

Dimensional Outline Drawings

TO-220AB



| Dim | Millimeters | |
|-----|-------------|-------|
| | MIN | MAX |
| A | 4.32 | 4.70 |
| A1 | 1.11 | 1.38 |
| A2 | 2.59 | 2.79 |
| b | 0.77 | 1.00 |
| b2 | 1.23 | 1.36 |
| C | 0.34 | 0.47 |
| D | 14.71 | 15.75 |
| D1 | 9.05 | 9.25 |
| E | 9.96 | 10.36 |
| e | 2.44 | 2.64 |
| e1 | 4.98 | 5.18 |
| L | 12.70 | 14.22 |
| L1 | – | 3.90 |
| ØP | 3.71 | 3.96 |
| Q | 2.54 | 2.90 |

| Mechanical Mounting Method | Maximum Torque / Pressure specification |
|-----------------------------------|---|
| Screw through hole in package tab | 1 Newton Meter (nm) or 8.8 inch-pounds (lb-in) |
| Clamp against package body | 12.3 kilogram-force per square centimeter (kgf/cm ²) or 175 lbf/in ² |

Soldering time and temperature: This product has been designed for use with high-temperature, lead-free solder. The component leads can be subjected to a maximum temperature of 300 °C, for up to 10 seconds. See Application Note AN-303, for more details.

Ordering Information

| Part Number | Package | Packing |
|-------------|----------|---------------|
| LXA16T600C | TO-220AB | 50 units/tube |

The information contained in this document is subject to change without notice.

LXA16T600C

| Revision | Notes | Date |
|----------|--|-------|
| 1.0 | Released by Qspeed | 06/10 |
| 1.1 | Converted to Power Integrations Document | 01/11 |

For the latest updates, visit our website: www.powerint.com

Power Integrations reserves the right to make changes to its products at any time to improve reliability or manufacturability. Power Integrations does not assume any liability arising from the use of any device or circuit described herein. POWER INTEGRATIONS MAKES NO WARRANTY HEREIN AND SPECIFICALLY DISCLAIMS ALL WARRANTIES INCLUDING, WITHOUT LIMITATION, THE IMPLIED WARRANTIES OF MERCHANTABILITY, FITNESS FOR A PARTICULAR PURPOSE, AND NON-INFRINGEMENT OF THIRD PARTY RIGHTS.

PATENT INFORMATION

The products and applications illustrated herein (including transformer construction and circuits external to the products) may be covered by one or more U.S. and foreign patents, or potentially by pending U.S. and foreign patent applications assigned to Power Integrations. A complete list of Power Integrations' patents may be found at www.powerint.com. Power Integrations grants its customers a license under certain patent rights as set forth at <http://www.powerint.com/ip.htm>.

The PI Logo, TOPSwitch, TinySwitch, LinkSwitch, DPA-Switch, PeakSwitch, CAPZero, SENZero, LinkZero, HiperPFS, HiperTFS, Qspeed, EcoSmart, Clampless, E-Shield, Filterfuse, StackFET, PI Expert and PI FACTS are trademarks of Power Integrations, Inc. Other trademarks are property of their respective companies. ©Copyright 2011 Power Integrations, Inc.

Power Integrations Worldwide Sales Support Locations**WORLD HEADQUARTERS**

5245 Hellyer Avenue
San Jose, CA 95138, USA.
Main: +1-408-414-9200
Customer Service:
Phone: +1-408-414-9665
Fax: +1-408-414-9765
e-mail:
usasales@powerint.com

GERMANY

Rueckertstrasse 3
D-80336, Munich
Germany
Phone: +49-89-5527-3911
Fax: +49-89-5527-3920
e-mail:
eurosales@powerint.com

JAPAN

Kosei Dai-3 Building
2-12-11, Shin-Yokohama,
Kohoku-ku, Yokohama-shi,
Kanagawa 222-0033
Japan
Phone: +81-45-471-1021
Fax: +81-45-471-3717
e-mail: japansales@powerint.com

TAIWAN

5F, No. 318, Nei Hu Rd., Sec. 1
Nei Hu District
Taipei 114, Taiwan R.O.C.
Phone: +886-2-2659-4570
Fax: +886-2-2659-4550
e-mail:
taiwansales@powerint.com

CHINA (SHANGHAI)

Rm 1601/1610, Tower 1
Kerry Everbright City
No. 218 Tianmu Road West
Shanghai, P.R.C. 200070
Phone: +86-021-6354-6323
Fax: +86-021-6354-6325
e-mail:
chinasales@powerint.com

INDIA

#1, 14th Main Road
Vasanthanagar
Bangalore-560052
India
Phone: +91-80-4113-8020
Fax: +91-80-4113-8023
e-mail:
indiasales@powerint.com

KOREA

RM 602, 6FL
Korea City Air Terminal B/D, 159-6
Samsung-Dong, Kangnam-Gu,
Seoul, 135-728
Korea
Phone: +82-2-2016-6610
Fax: +82-2-2016-6630
e-mail: koreasales@powerint.com

EUROPE HQ

1st Floor, St. James's House
East Street, Farnham
Surrey GU9 7TJ
United Kingdom
Phone: +44 (0) 1252-730-141
Fax: +44 (0) 1252-727-689
e-mail:
eurosales@powerint.com

CHINA (SHENZHEN)

Rm A, B & C 4th Floor, Block C,
Electronics Science and
Technology Building
2070 Shennan Zhong Road
Shenzhen, Guangdong,
P.R.C. 518031
Phone: +86-755-8379-3243
Fax: +86-755-8379-5828
e-mail:
chinasales@powerint.com

ITALY

Via De Amicis 2
20091 Bresso MI
Italy
Phone: +39-028-928-6000
Fax: +39-028-928-6009
e-mail:
eurosales@powerint.com

SINGAPORE

51 Newton Road,
#19-01/05 Goldhill Plaza
Singapore, 308900
Phone: +65-6358-2160
Fax: +65-6358-2015
e-mail:
singaporesales@powerint.com

APPLICATIONS HOTLINE

World Wide +1-408-414-9660

APPLICATIONS FAX

World Wide +1-408-414-9760