

# Complementary MOSFET

## ELM36601EA-S

### ■ General Description

ELM36601EA-S uses advanced trench technology to provide excellent  $R_{ds(on)}$  and low gate charge.

### ■ Features

- |  |  |
|--|--|
| N-channel                                | P-channel                                |
| • $V_{ds}=30V$                           | $V_{ds}=-30V$                            |
| • $I_d=3.5A$                             | $I_d=-2A$                                |
| • $R_{ds(on)} < 58m\Omega (V_{gs}=10V)$  | $R_{ds(on)} < 115m\Omega (V_{gs}=-10V)$  |
| • $R_{ds(on)} < 88m\Omega (V_{gs}=4.5V)$ | $R_{ds(on)} < 185m\Omega (V_{gs}=-4.5V)$ |

### ■ Maximum Absolute Ratings

Parameter	Symbol	N-ch (Max.)	P-ch (Max.)	Unit	Note
Drain-source voltage	$V_{ds}$	30	-30	V	
Gate-source voltage	$V_{gs}$	$\pm 20$	$\pm 20$	V	
Continuous drain current	$I_d$	$T_a=25^\circ C$	-2.3	A	
		$T_a=70^\circ C$	-1.8		
Pulsed drain current	$I_{dm}$	10	-10	A	3
Power dissipation	$P_d$	$T_a=25^\circ C$	1.15	W	
		$T_a=70^\circ C$	0.73		
Junction and storage temperature range	$T_j, T_{stg}$	-55 to 150	-55 to 150	$^\circ C$	

### ■ Thermal Characteristics

Parameter	Symbol	Device	Typ.	Max.	Unit	Note
Maximum junction-to-ambient	$R_{\theta ja}$	N-ch		110	$^\circ C/W$	
Maximum junction-to-ambient				Steady-state		
Maximum junction-to-lead	Steady-state		$R_{\theta jl}$	80		
Maximum junction-to-ambient	$R_{\theta ja}$	P-ch		110	$^\circ C/W$	
Maximum junction-to-ambient				Steady-state		
Maximum junction-to-lead	Steady-state		$R_{\theta jl}$	80		

### ■ Pin Configuration

SOT-26(TOP VIEW)

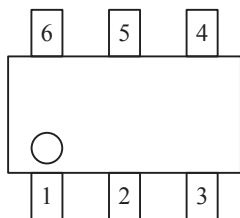

Pin No.	Pin name
1	GATE1
2	SOURCE2
3	GATE2
4	DRAIN2
5	SOURCE1
6	DRAIN1

### ■ Circuit

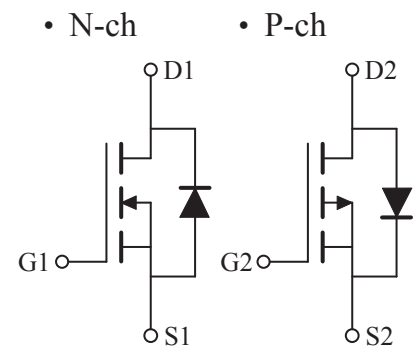

# Complementary MOSFET

## ELM36601EA-S

### ■Electrical Characteristics (N-ch)

Ta=25°C

Parameter	Symbol	Conditions	Min.	Typ.	Max.	Unit	Note	
<b>STATIC PARAMETERS</b>								
Drain-source breakdown voltage	BV <sub>dss</sub>	I <sub>d</sub> =250μA, V <sub>gs</sub> =0V	30			V		
Zero gate voltage drain current	I <sub>dss</sub>	V <sub>ds</sub> =24V, V <sub>gs</sub> =0V			1	μA		
		V <sub>ds</sub> =20V, V <sub>gs</sub> =0V, T <sub>j</sub> =55°C			10			
Gate-body leakage current	I <sub>gss</sub>	V <sub>ds</sub> =0V, V <sub>gs</sub> =±20V			±100	nA		
Gate threshold voltage	V <sub>gs(th)</sub>	V <sub>ds</sub> =V <sub>gs</sub> , I <sub>d</sub> =250μA	1.0	1.5	2.5	V		
On state drain current	I <sub>d(on)</sub>	V <sub>gs</sub> =10V, V <sub>ds</sub> =5V	8			A	1	
Static drain-source on-resistance	R <sub>ds(on)</sub>	V <sub>gs</sub> =10V, I <sub>d</sub> =3.5A		50	58	mΩ	1	
		V <sub>gs</sub> =4.5V, I <sub>d</sub> =2A		69	88			
Forward transconductance	G <sub>fs</sub>	V <sub>ds</sub> =5V, I <sub>d</sub> =2.5A		4.5		S	1	
Diode forward voltage	V <sub>sd</sub>	I <sub>f</sub> =0.8A, V <sub>gs</sub> =0V			1.2	V	1	
<b>DYNAMIC PARAMETERS</b>								
Input capacitance	C <sub>iss</sub>	V <sub>gs</sub> =0V, V <sub>ds</sub> =15V, f=1MHz		202		pF		
Output capacitance	C <sub>oss</sub>				40		pF	
Reverse transfer capacitance	C <sub>rss</sub>				20		pF	
<b>SWITCHING PARAMETERS</b>								
Total gate charge	Q <sub>g</sub>	V <sub>gs</sub> =10V, V <sub>ds</sub> =15V, I <sub>d</sub> =3.5A		2.6	3.9	nC	2	
Gate-source charge	Q <sub>gs</sub>				0.9		nC	2
Gate-drain charge	Q <sub>gd</sub>				0.6		nC	2
Turn-on delay time	t <sub>d(on)</sub>	V <sub>gs</sub> =10V, V <sub>ds</sub> =15V, I <sub>d</sub> ≈1A R <sub>L</sub> =15Ω, R <sub>gen</sub> =6Ω		7	11	ns	2	
Turn-on rise time	t <sub>r</sub>				12	18	ns	2
Turn-off delay time	t <sub>d(off)</sub>				12	18	ns	2
Turn-off fall time	t <sub>f</sub>				7	11	ns	2
Body-diode reverse recovery time	t <sub>rr</sub>	I <sub>f</sub> =0.8A, dI/dt=100A/μs		40	80	ns		

#### NOTE :

1. Pulse test : Pulse width ≤ 300μsec, duty cycle ≤ 2%.
2. Independent of operating temperature.
3. Pulse width limited by maximum junction temperature.
4. Duty cycle ≤ 1%.

# Complementary MOSFET

## ELM36601EA-S

### ■ Typical Electrical and Thermal Characteristics

#### N-CHANNEL

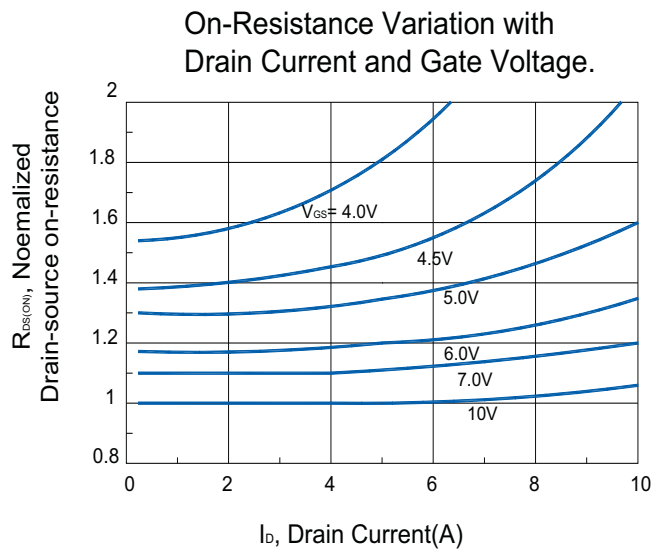
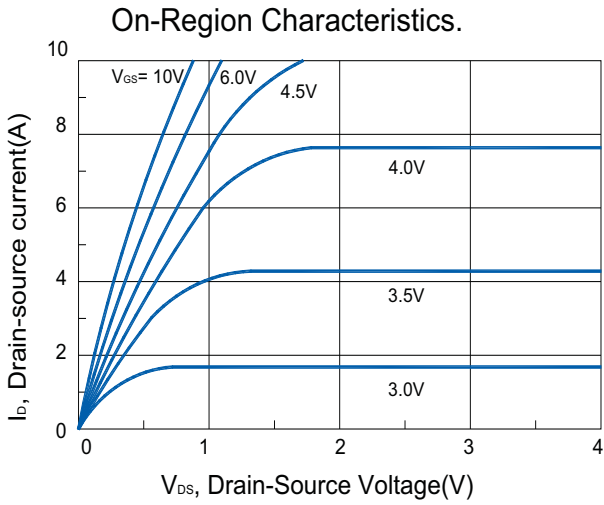

**On-Resistance Variation with Temperature.**

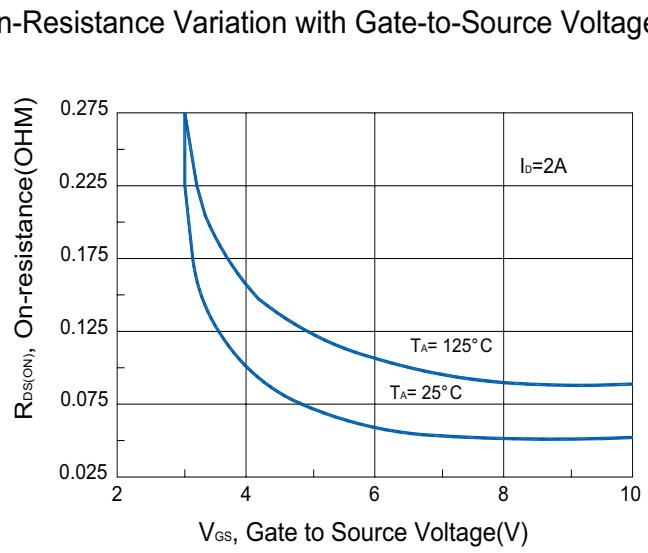
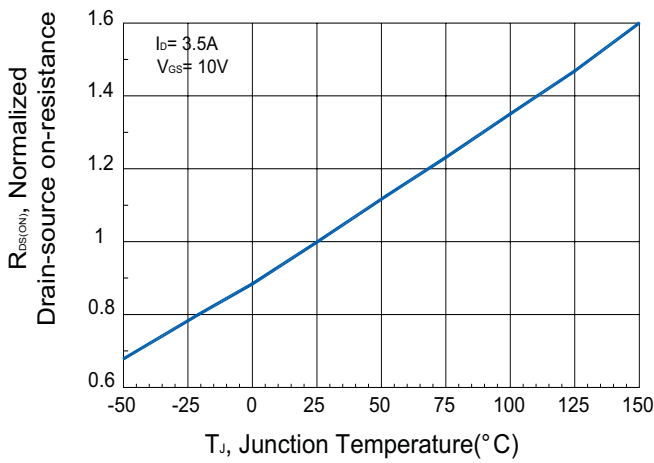

#### Transfer Characteristics.

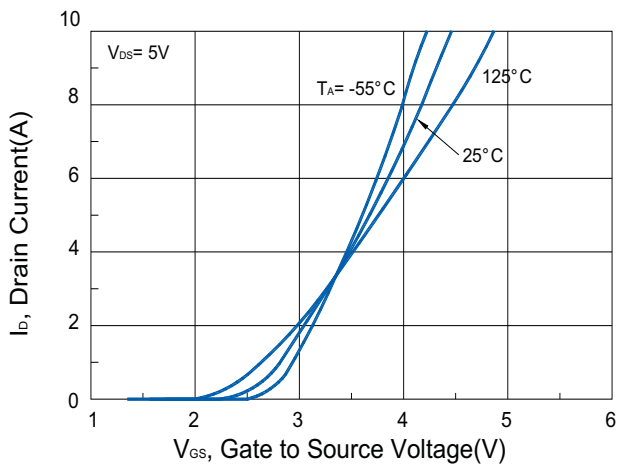

#### Body Diode Forward Voltage Variation with Source Current and Temperature.

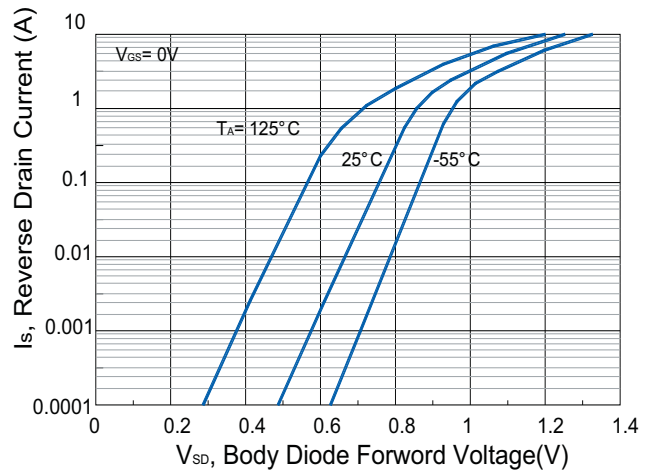

# Complementary MOSFET

## ELM36601EA-S

Gate-Charge Characteristics

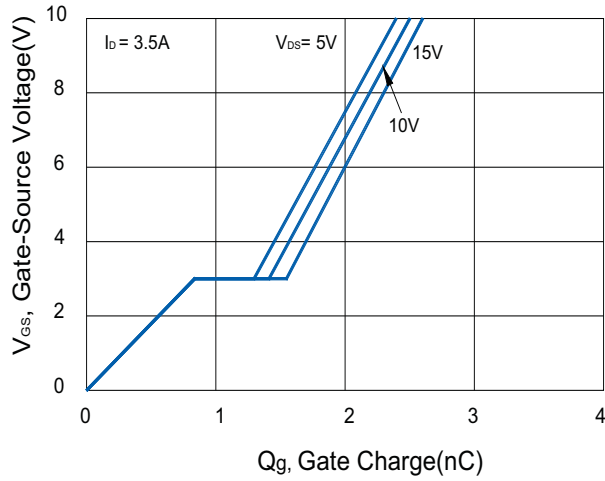

Capacitance Characteristics

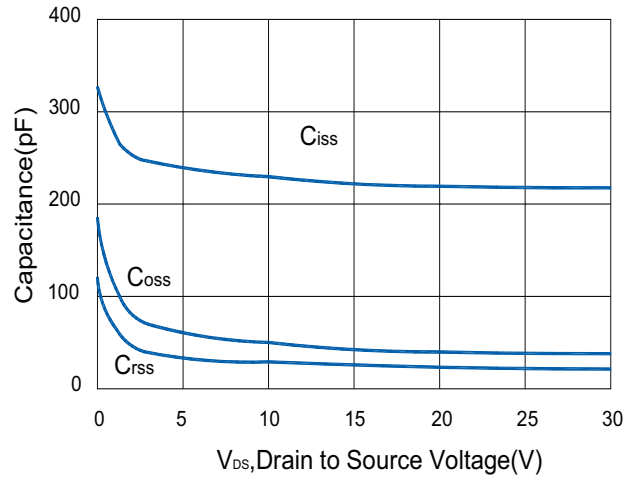

Maximum Safe Operating Area.

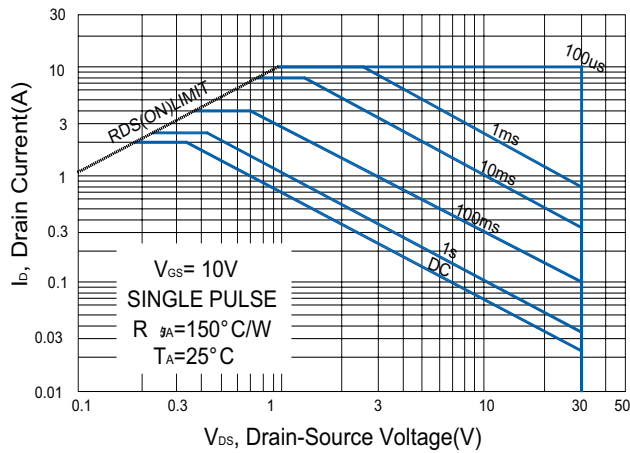

Single Pulse Maximum Power Dissipation.

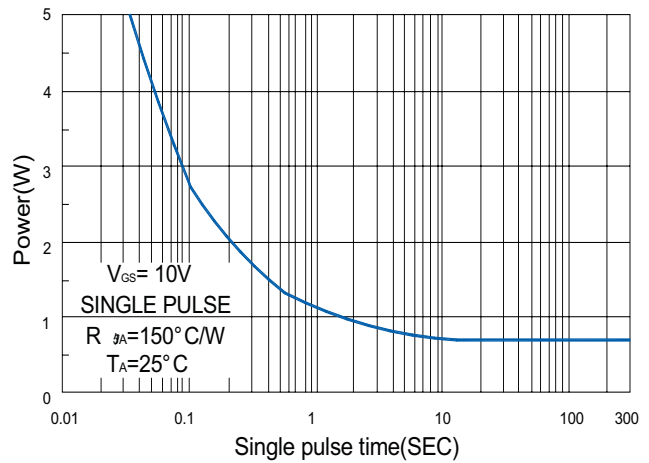

# Complementary MOSFET

## ELM36601EA-S

### ■Electrical Characteristics (P-ch)

Ta=25°C

Parameter	Symbol	Conditions	Min.	Typ.	Max.	Unit	Note
<b>STATIC PARAMETERS</b>							
Drain-source breakdown voltage	BVdss	Id=-250μA, Vgs=0V	-30			V	
Zero gate voltage drain current	Idss	Vds=-24V, Vgs=0V			-1	μA	
		Vds=-20V, Vgs=0V, Tj=55°C			-10		
Gate-body leakage current	Igss	Vds=0V, Vgs=±20V			±100	nA	
Gate threshold voltage	Vgs(th)	Vds=Vgs, Id=-250μA	-1.0	-1.5	-2.5	V	
On state drain current	Id(on)	Vgs=-10V, Vds=-5V	-8			A	1
Static drain-source on-resistance	Rds(on)	Vgs=-10V, Id=-2.3A		95	115	mΩ	1
		Vgs=-4.5V, Id=-1.5A		145	185		
Forward transconductance	Gfs	Vds=-5V, Id=-2A		3		S	1
Diode forward voltage	Vsd	If=-0.8A, Vgs=0V			-1.2	V	1
<b>DYNAMIC PARAMETERS</b>							
Input capacitance	Ciss	Vgs=0V, Vds=-15V, f=1MHz		225		pF	
Output capacitance	Coss			60		pF	
Reverse transfer capacitance	Crss			30		pF	
<b>SWITCHING PARAMETERS</b>							
Total gate charge	Qg	Vgs=-10V, Vds=-15V Id=-2A		2.8	4.2	nC	2
Gate-source charge	Qgs			1.0		nC	2
Gate-drain charge	Qgd			0.7		nC	2
Turn-on delay time	td(on)	Vgs=-10V, Vds=-15V, Id≈-1A RL=15Ω, Rgen=6Ω		8	12	ns	2
Turn-on rise time	tr			11	18	ns	2
Turn-off delay time	td(off)			14	21	ns	2
Turn-off fall time	tf			8	12	ns	2
Body-diode reverse recovery time	trr	If=-0.8A, dl/dt=100A/μs		40	80	ns	

NOTE :

1. Pulse test : Pulse width ≤ 300μsec, duty cycle ≤ 2%.
2. Independent of operating temperature.
3. Pulse width limited by maximum junction temperature.

# Complementary MOSFET

## ELM36601EA-S

### Typical Electrical and Thermal Characteristics

#### P-CHANNEL

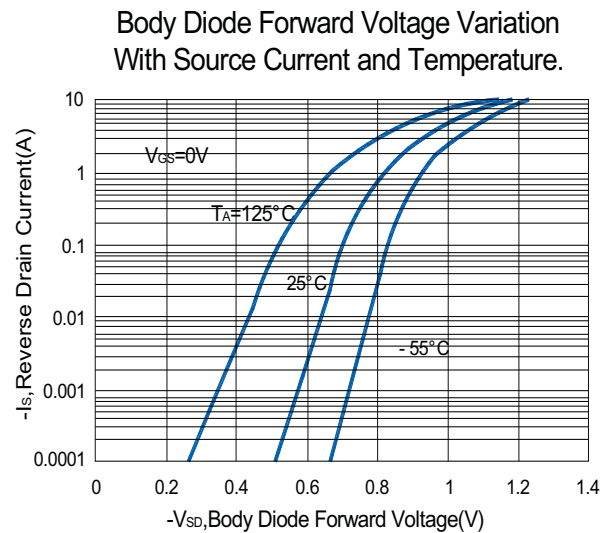
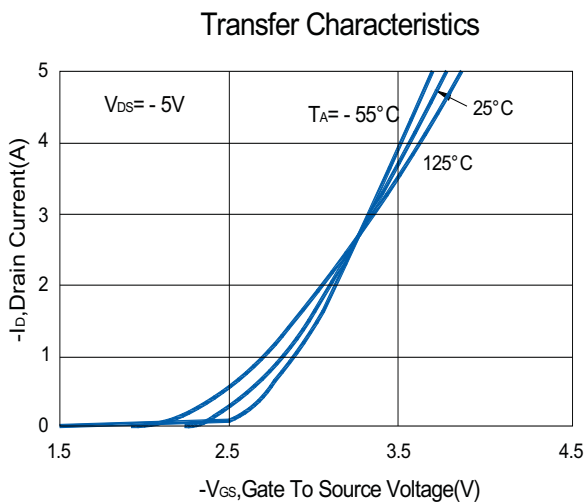
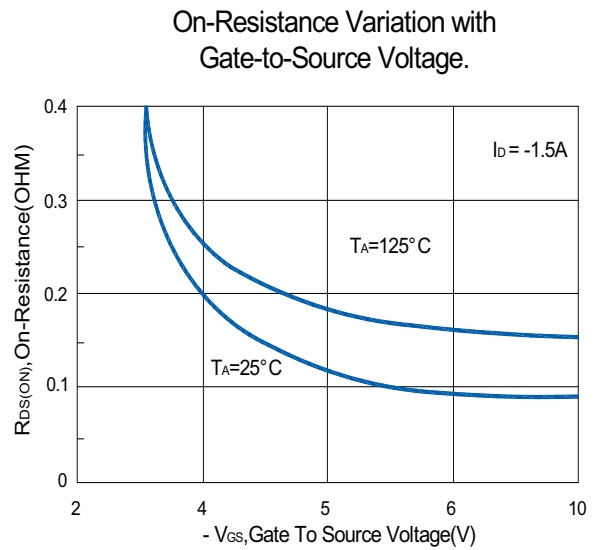
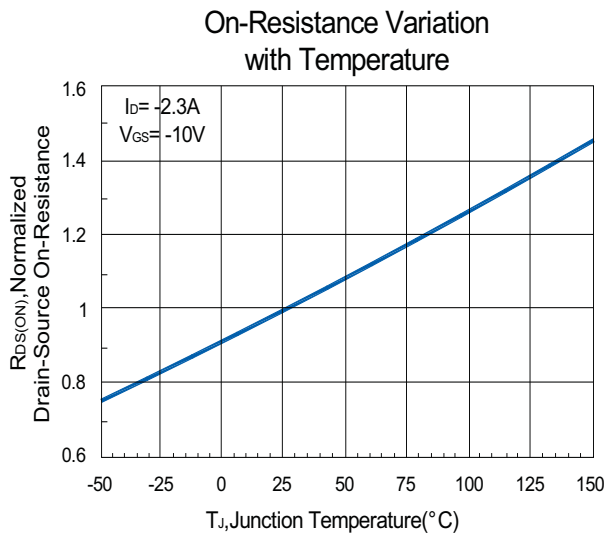
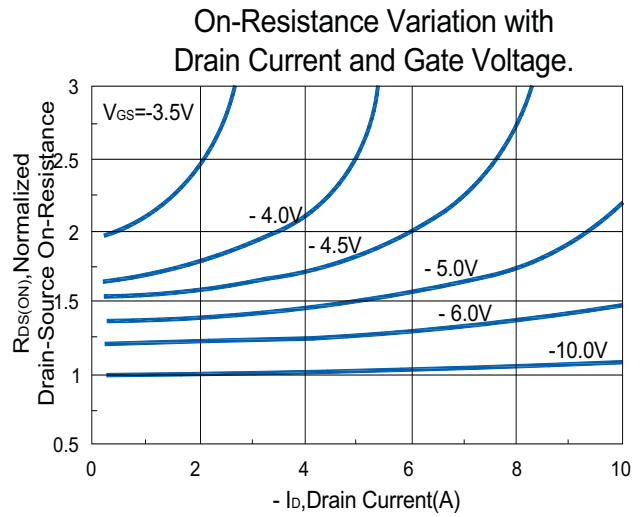
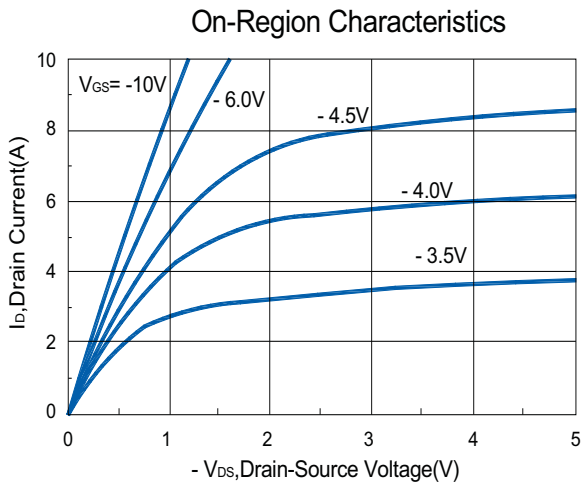

# Complementary MOSFET

## ELM36601EA-S

Gate-Charge Characteristics

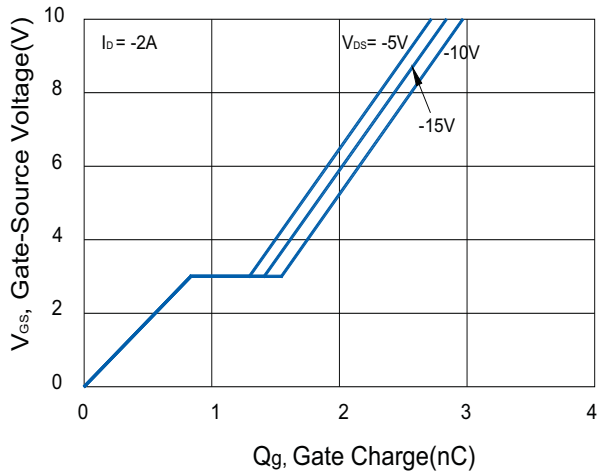

Capacitance Characteristics

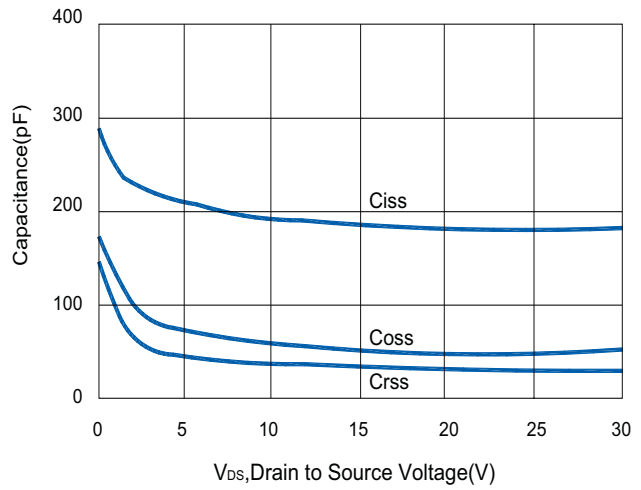

Maximum Safe Operating Area.

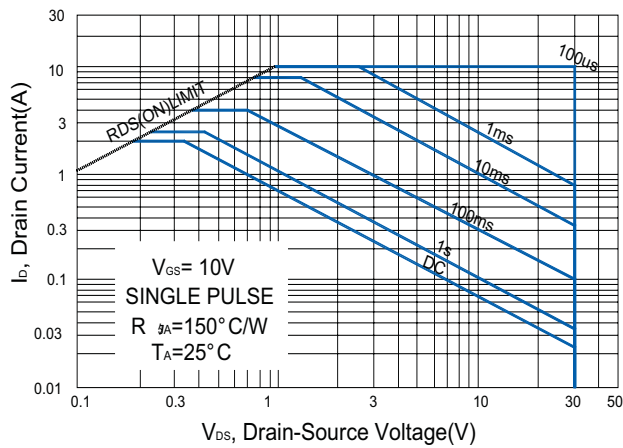

Single Pulse Maximum Power Dissipation.

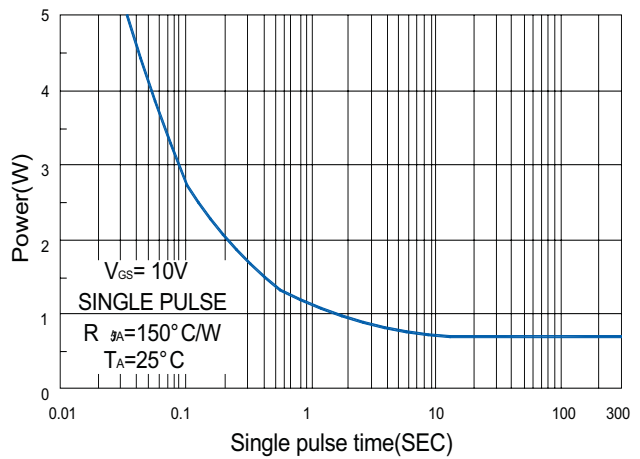

Transient Thermal Response Curve.

