

International IR Rectifier

RADIATION HARDENED LOGIC LEVEL POWER MOSFET SURFACE MOUNT (SMD-2)

2N7622U2
IRHLNA797064
60V, P-CHANNEL
TECHNOLOGY



Product Summary

Part Number	Radiation Level	R _{DS(on)}	I _D
IRHLNA797064	100K Rads (Si)	0.015Ω	-56A*
IRHLNA793064	300K Rads (Si)	0.015Ω	-56A*



International Rectifier's R7TM Logic Level Power MOSFETs provide simple solution to interfacing CMOS and TTL control circuits to power devices in space and other radiation environments. The threshold voltage remains within acceptable operating limits over the full operating temperature and post radiation. This is achieved while maintaining single event gate rupture and single event burnout immunity.

These devices are used in applications such as current boost low signal source in PWM, voltage comparator and operational amplifiers.

Features:

- 5V CMOS and TTL Compatible
- Fast Switching
- Single Event Effect (SEE) Hardened
- Low Total Gate Charge
- Simple Drive Requirements
- Ease of Paralleling
- Hermetically Sealed
- Ceramic Package
- Surface Mount
- Light Weight

Absolute Maximum Ratings

Pre-Irradiation

	Parameter		Units
I _D @ V _{GS} = -4.5V, T _C = 25°C	Continuous Drain Current	-56*	A
I _D @ V _{GS} = -4.5V, T _C = 100°C	Continuous Drain Current	-56*	
I _{DM}	Pulsed Drain Current ①	-224	
P _D @ T _C = 25°C	Max. Power Dissipation	250	W
	Linear Derating Factor	2.0	W/°C
V _{GS}	Gate-to-Source Voltage	±10	V
EAS	Single Pulse Avalanche Energy ②	1060	mJ
I _{AR}	Avalanche Current ①	-56	A
E _{AR}	Repetitive Avalanche Energy ①	25	mJ
dv/dt	Peak Diode Recovery dv/dt ③	-3.7	V/ns
T _J	Operating Junction	-55 to 150	°C
T _{STG}	Storage Temperature Range		
	Pckg. Mounting Surface Temp.	300 (for 5s)	
	Weight	3.3 (Typical)	g

* Current is limited by package

For footnotes refer to the last page

www.irf.com

Electrical Characteristics @ T_j = 25°C (Unless Otherwise Specified)

	Parameter	Min	Typ	Max	Units	Test Conditions
BVDSS	Drain-to-Source Breakdown Voltage	-60	—	—	V	V _{GS} = 0V, I _D = -250μA
ΔBVDSS/ΔT _J	Temperature Coefficient of Breakdown Voltage	—	-0.06	—	V/°C	Reference to 25°C, I _D = -1.0mA
RDS(on)	Static Drain-to-Source On-State Resistance	—	—	0.015	Ω	V _{GS} = -4.5V, I _D = -56A ④
VGS(th)	Gate Threshold Voltage	-1.0	—	-2.0	V	V _{DS} = V _{GS} , I _D = -250μA
ΔVGS(th)/ΔT _J	Gate Threshold Voltage Coefficient	—	4.1	—	mV/°C	
g _{fs}	Forward Transconductance	82	—	—	S	V _{DS} = -15V, I _{DS} = -56A ④
I _{DSS}	Zero Gate Voltage Drain Current	—	—	-1.0	μA	V _{DS} = -48V, V _{GS} = 0V
		—	—	-10		V _{DS} = -48V, V _{GS} = 0V, T _J = 125°C
I _{GSS}	Gate-to-Source Leakage Forward	—	—	-100	nA	V _{GS} = -10V
I _{GSS}	Gate-to-Source Leakage Reverse	—	—	100		V _{GS} = 10V
Q _g	Total Gate Charge	—	—	190	nC	V _{GS} = -4.5V, I _D = -56A
Q _{gs}	Gate-to-Source Charge	—	—	53		V _{DS} = -30V
Q _{gd}	Gate-to-Drain ('Miller') Charge	—	—	56		
t _{d(on)}	Turn-On Delay Time	—	—	38	ns	V _{DD} = -30V, I _D = -56A, V _{GS} = -6.0V, R _G = 2.35Ω
t _r	Rise Time	—	—	265		
t _{d(off)}	Turn-Off Delay Time	—	—	210		
t _f	Fall Time	—	—	70		
L _S + L _D	Total Inductance	—	4.0	—	nH	Measured from the center of drain pad to center of source pad
C _{iss}	Input Capacitance	—	10520	—	pF	V _{GS} = 0V, V _{DS} = -25V f = 1.0MHz
C _{oss}	Output Capacitance	—	2780	—		
C _{rss}	Reverse Transfer Capacitance	—	310	—		
R _g	Gate Resistance	—	2.3	—		

Source-Drain Diode Ratings and Characteristics

	Parameter	Min	Typ	Max	Units	Test Conditions
I _S	Continuous Source Current (Body Diode)	—	—	-56*	A	T _j = 25°C, I _S = -56A, V _{GS} = 0V ④
I _{SM}	Pulse Source Current (Body Diode) ①	—	—	-224		
V _{SD}	Diode Forward Voltage	—	—	-5.0	V	T _j = 25°C, I _F = -56A, di/dt ≤ -100A/μs
t _{rr}	Reverse Recovery Time	—	—	159	ns	V _{DD} ≤ -25V ④
Q _{RR}	Reverse Recovery Charge	—	—	430	nC	
t _{on}	Forward Turn-On Time	Intrinsic turn-on time is negligible. Turn-on speed is substantially controlled by L _S + L _D .				

* Current is limited by package

Thermal Resistance

	Parameter	Min	Typ	Max	Units	Test Conditions
R _{thJC}	Junction-to-Case	—	—	0.5	°C/W	soldered to a 2" square copper-cladboard
R _{thJ-PCB}	Junction-to-PC board	—	1.6	—		

Note: Corresponding Spice and Saber models are available on International Rectifier Web site.

For footnotes refer to the last page

Radiation Characteristics

IRHLNA797064, 2N7622U2

International Rectifier Radiation Hardened MOSFETs are tested to verify their radiation hardness capability. The hardness assurance program at International Rectifier is comprised of two radiation environments. Every manufacturing lot is tested for total ionizing dose (per notes 5 and 6) using the TO-3 package. Both pre- and post-irradiation performance are tested and specified using the same drive circuitry and test conditions in order to provide a direct comparison.

Table 1. Electrical Characteristics @ Tj = 25°C, Post Total Dose Irradiation ⑤⑥

	Parameter	Upto 300K Rads (Si) ¹		Units	Test Conditions
		Min	Max		
BV _{DSS}	Drain-to-Source Breakdown Voltage	-60	—	V	V _{GS} = 0V, I _D = -250μA
V _{GS(th)}	Gate Threshold Voltage	-1.0	-2.0		V _{GS} = V _{DS} , I _D = -250μA
I _{GSS}	Gate-to-Source Leakage Forward	—	-100	nA	V _{GS} = -10V
I _{GSS}	Gate-to-Source Leakage Reverse	—	100	nA	V _{GS} = 10V
I _{DSS}	Zero Gate Voltage Drain Current	—	-10	μA	V _{DS} = -48V, V _{GS} = 0V
R _{DS(on)}	Static Drain-to-Source On-State Resistance (TO-3) ④	—	0.015	Ω	V _{GS} = -4.5V, I _D = -56A
R _{DS(on)}	Static Drain-to-Source On-state Resistance (SMD-2) ④	—	0.015	Ω	V _{GS} = -4.5V, I _D = -56A
V _{SD}	Diode Forward Voltage④	—	-5.0	V	V _{GS} = 0V, I _D = -56A

1. Part numbers IRHLNA797064, IRHLNA793064

International Rectifier radiation hardened MOSFETs have been characterized in heavy ion environment for Single Event Effects (SEE). Single Event Effects characterization is illustrated in Fig. a and Table 2.

Table 2. Single Event Effect Safe Operating Area

Ion	LET (MeV/(mg/cm ²))	Energy (MeV)	Range (μm)	VDS (V)							
				@VGS= 0V	@VGS= 2V	@VGS= 4V	@VGS= 5V	@VGS= 6V	@VGS= 7V	@VGS= 8V	@VGS= 10V
Br	37	305	39	-60	-60	-60	-60	-40	-30	-25	-20
I	60	370	34	-60	-60	-60	-40	-20	-	-	-
Au	82	390	30	-60	-60	-60	-	-	-	-	-

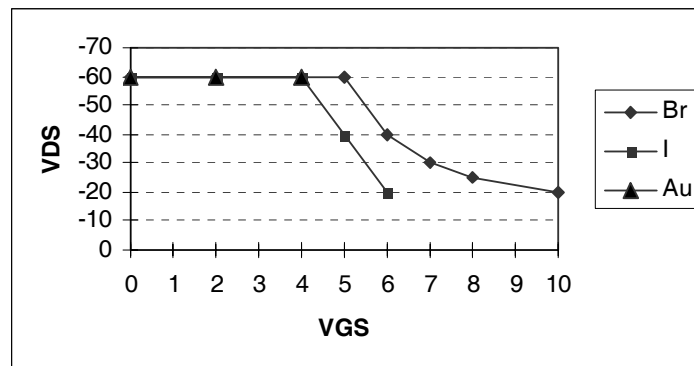

Fig a. Single Event Effect, Safe Operating Area

For footnotes refer to the last page

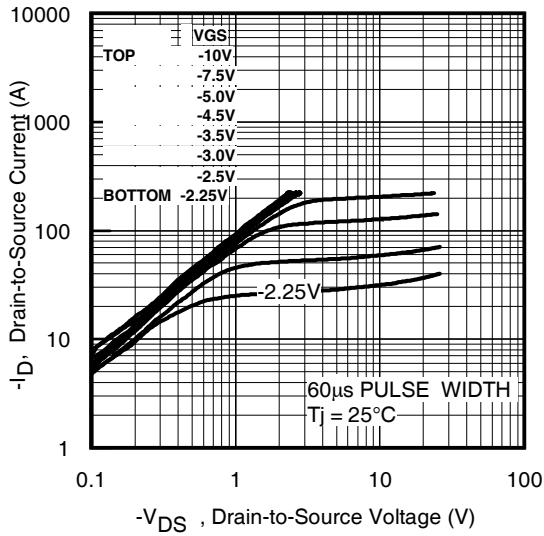

Fig 1. Typical Output Characteristics

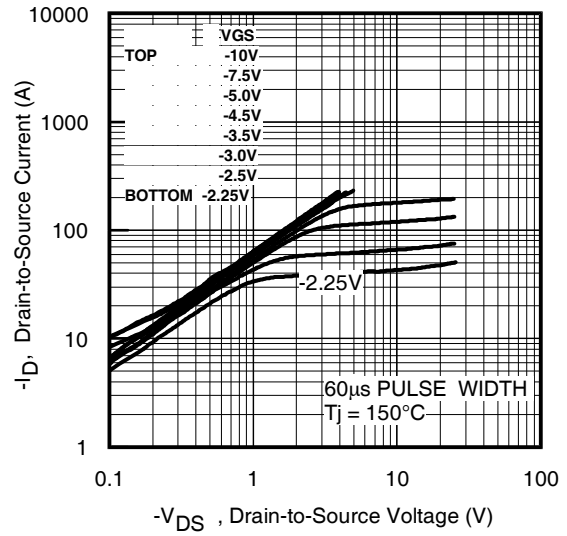

Fig 2. Typical Output Characteristics

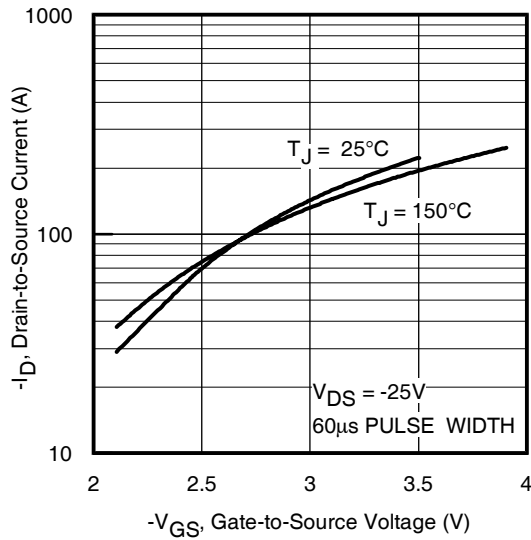

Fig 3. Typical Transfer Characteristics

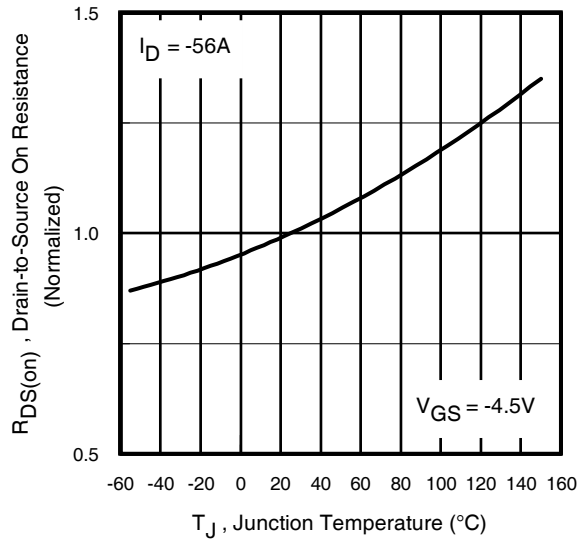

Fig 4. Normalized On-Resistance Vs. Temperature

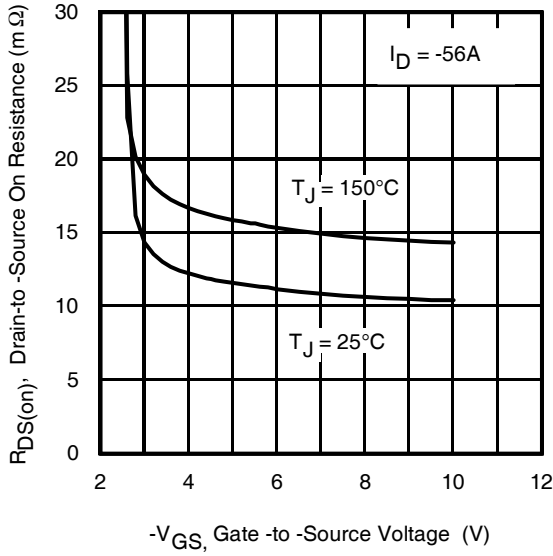

Fig 5. Typical On-Resistance Vs Gate Voltage

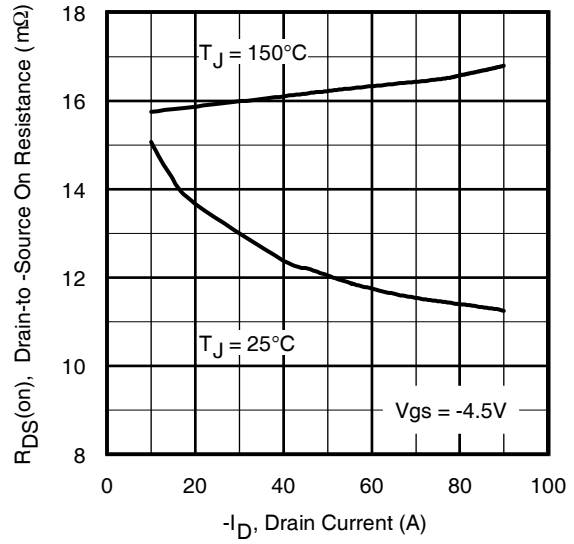

Fig 6. Typical On-Resistance Vs Drain Current

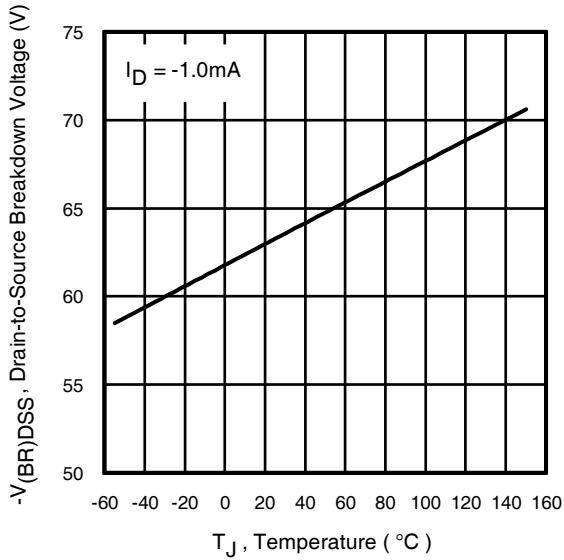

Fig 7. Typical Drain-to-Source Breakdown Voltage Vs Temperature

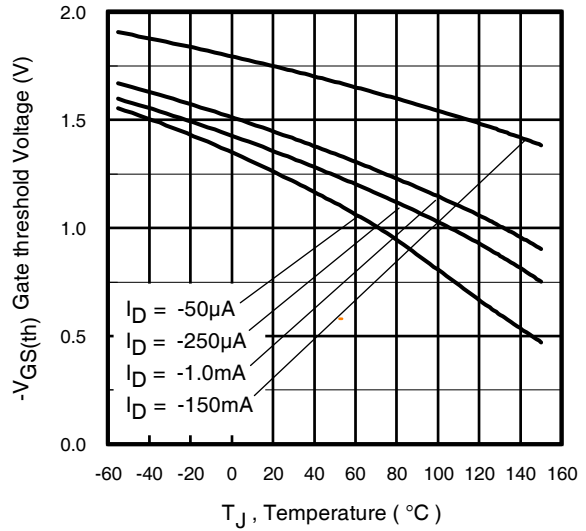

Fig 8. Typical Threshold Voltage Vs Temperature

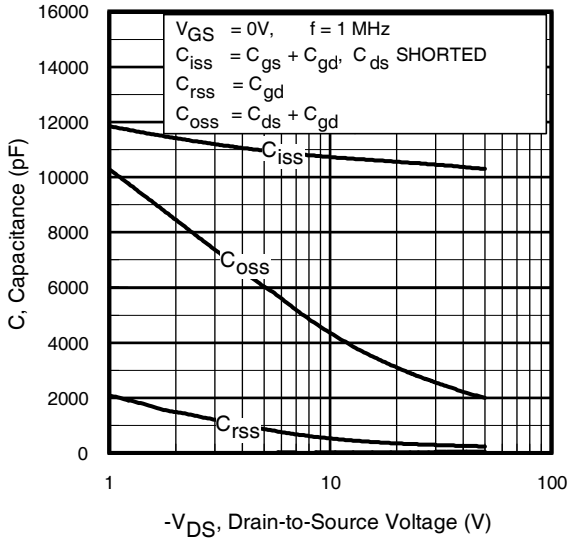

Fig 9. Typical Capacitance Vs. Drain-to-Source Voltage

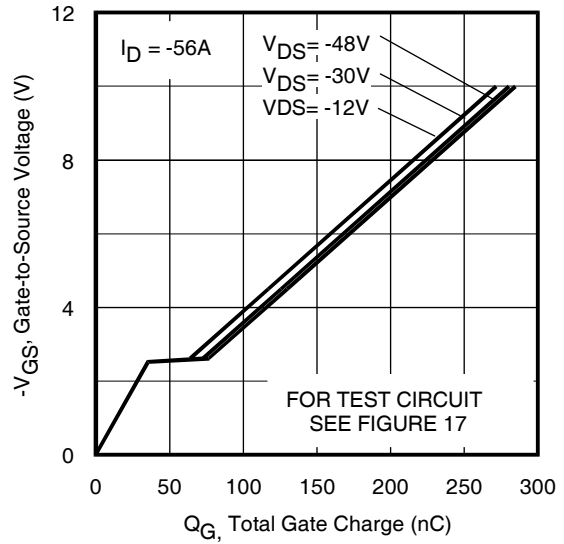

Fig 10. Typical Gate Charge Vs. Gate-to-Source Voltage

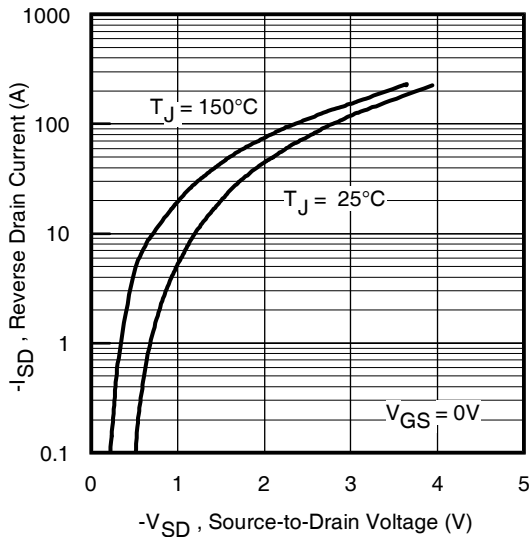

Fig 11. Typical Source-to-Drain Diode Forward Voltage

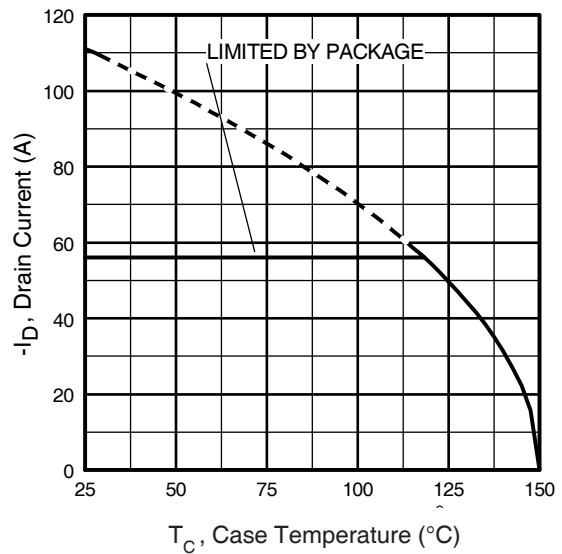

Fig12. Maximum Drain Current Vs. Case Temperature

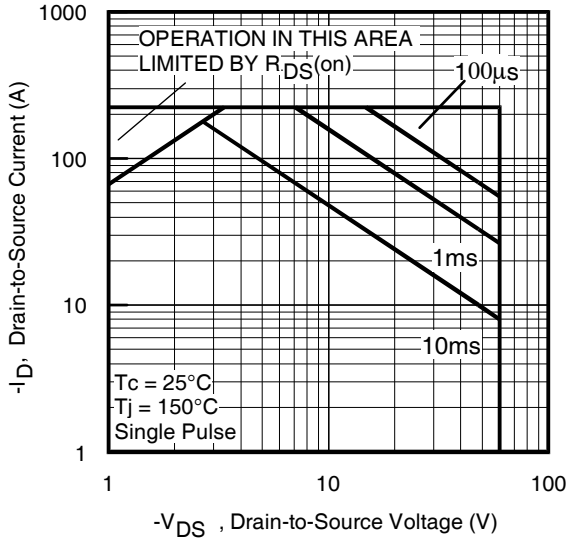

Fig 13. Maximum Safe Operating Area

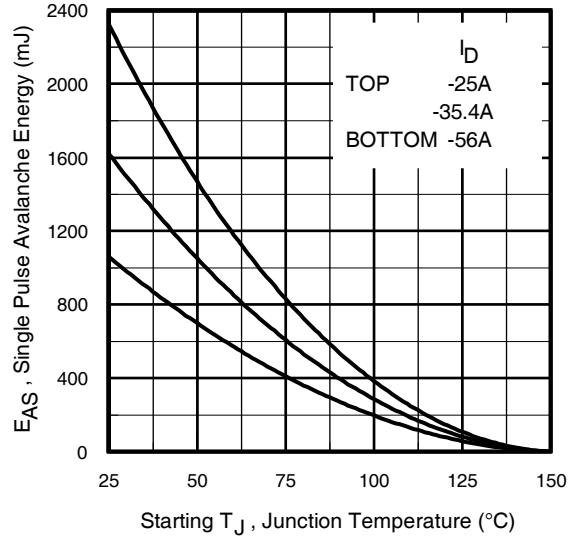

Fig 14. Maximum Avalanche Energy Vs. Drain Current

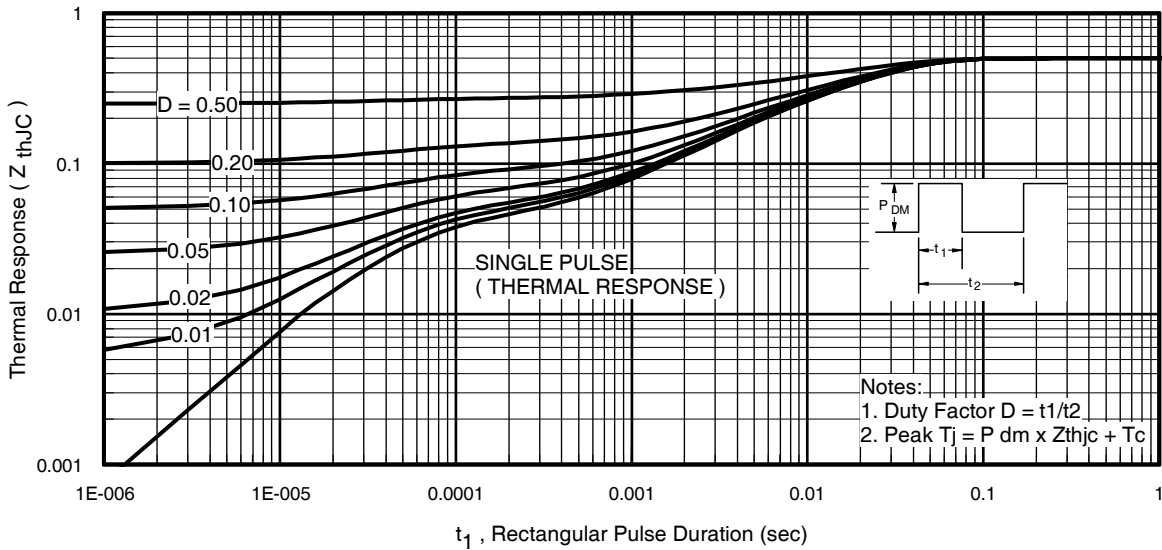

Fig 15. Maximum Effective Transient Thermal Impedance, Junction-to-Case

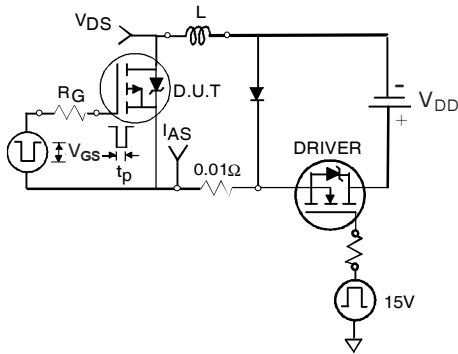

Fig 16a. Unclamped Inductive Test Circuit

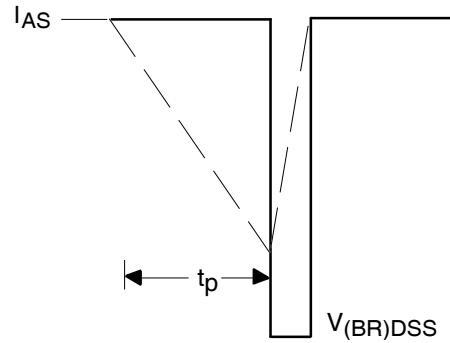

Fig 16b. Unclamped Inductive Waveforms

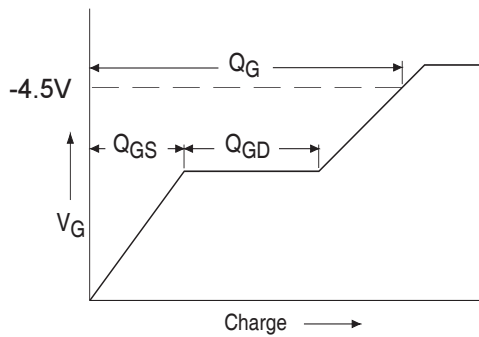

Fig 17a. Basic Gate Charge Waveform

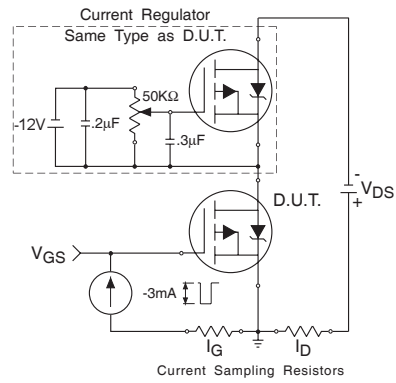

Fig 17b. Gate Charge Test Circuit

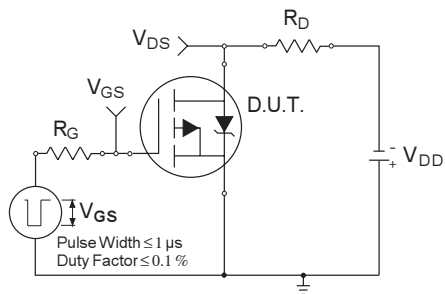

Fig 18a. Switching Time Test Circuit

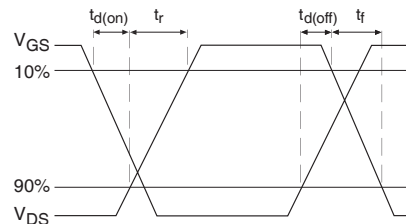

Fig 18b. Switching Time Waveforms

Pre-Irradiation

IRHLNA797064, 2N7622U2

Footnotes:

- ① Repetitive Rating; Pulse width limited by maximum junction temperature.
- ② $V_{DD} = -25V$, starting $T_J = 25^\circ C$, $L = 0.67mH$
Peak $I_L = -56A$, $V_{GS} = -10V$
- ③ $I_{SD} \leq -56A$, $di/dt \leq -380A/\mu s$,
 $V_{DD} \leq -60V$, $T_J \leq 150^\circ C$
- ④ Pulse width $\leq 300 \mu s$; Duty Cycle $\leq 2\%$
- ⑤ **Total Dose Irradiation with V_{GS} Bias.**
-10 volt V_{GS} applied and $V_{DS} = 0$ during irradiation per MIL-STD-750, method 1019, condition A.
- ⑥ **Total Dose Irradiation with V_{DS} Bias.**
-48 volt V_{DS} applied and $V_{GS} = 0$ during irradiation per MIL-STD-750, method 1019, condition A.

Case Outline and Dimensions — SMD-2

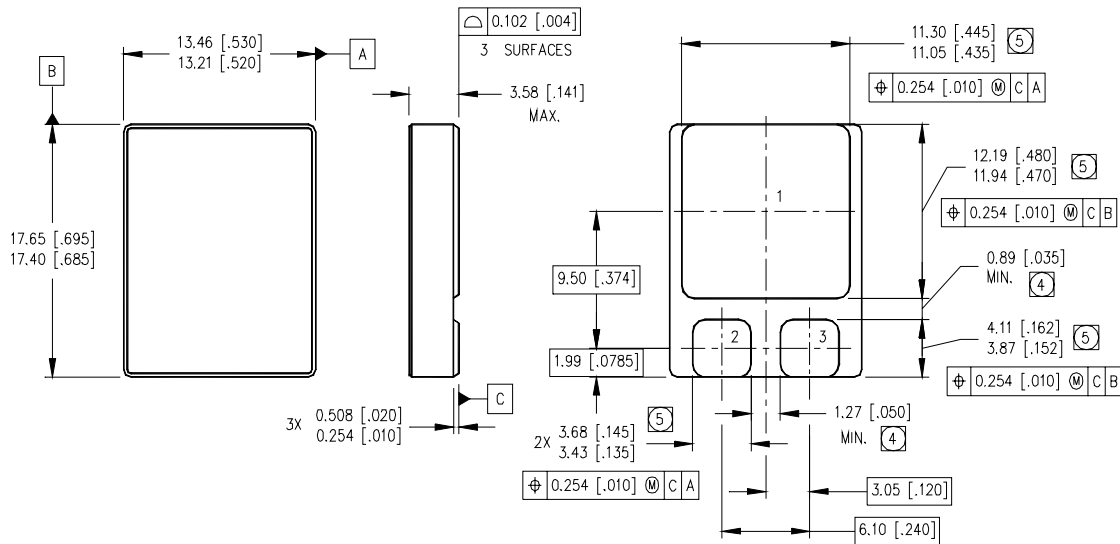

NOTES:

1. DIMENSIONING & TOLERANCING PER ASME Y14.5M-1994.
2. CONTROLLING DIMENSION: INCH.
3. DIMENSIONS ARE SHOWN IN MILLIMETERS [INCHES].

- ④ DIMENSION INCLUDES METALLIZATION FLASH.
- ⑤ DIMENSION DOES NOT INCLUDE METALLIZATION FLASH.

PAD ASSIGNMENTS

- 1 = DRAIN
- 2 = GATE
- 3 = SOURCE

International
IR Rectifier

IR WORLD HEADQUARTERS: 233 Kansas St., El Segundo, California 90245, USA Tel: (310) 252-7105

IR LEOMINSTER : 205 Crawford St., Leominster, Massachusetts 01453, USA Tel: (978) 534-5776

TAC Fax: (310) 252-7903

Visit us at www.irf.com for sales contact information.

Data and specifications subject to change without notice. 06/2007