

# SKiiP 39AHB16V1

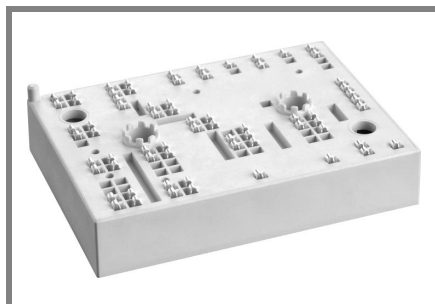

## MiniSKiiP® 3

### 3-phase bridge rectifier + brake chopper

#### SKiiP 39AHB16V1

#### Features

- Fast Trench IGBTs
- Robust and soft freewheeling diodes in CAL technology
- Highly reliable spring contacts for electrical connections
- UL recognised file no. E63532

#### Typical Applications

- Input bridge for inverter up to 45 kVA

#### Remarks

- $V_{CEsat}$ ,  $V_F$  = chip level value

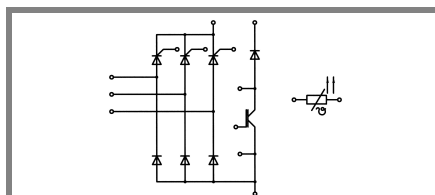

#### AHB

Absolute Maximum Ratings		$T_s = 25\text{ °C}$ , unless otherwise specified	
Symbol	Conditions	Values	Units
<b>IGBT - Chopper</b>			
$V_{CES}$		1200	V
$I_C$	$T_s = 25\text{ (70) °C}$	157 (118)	A
$I_{CRM}$	$t_p \leq 1\text{ ms}$	280	A
$V_{GES}$		$\pm 20$	V
$T_j$		- 40 ... + 150	°C
<b>Diode - Chopper</b>			
$I_F$	$T_s = 25\text{ (70) °C}$	167 (124)	A
$I_{FRM}$	$t_p \leq 1\text{ ms}$	280	A
$T_j$		- 40 ... + 150	°C
<b>Diode / Thyristor - Rectifier</b>			
$V_{RRM}$		1600	V
$I_F / I_T$	$T_s = 70$	121	A
$I_{FSM} / I_{TSM}$	$t_p = 10\text{ ms}$ , sin 180°, $T_j = 25\text{ °C}$	1250	A
$i^2t$	$t_p = 10\text{ ms}$ , sin 180°, $T_j = 25\text{ °C}$	7800	A <sup>2</sup> s
$T_j$	Diode	- 40 ... + 150	°C
$T_j$	Thyristor	- 40 ... + 125	°C
$I_{RMS}$	per power terminal (20 A / spring)	160	A
$T_{stg}$	$T_{op} \leq T_{stg}$	- 40 ... + 125	°C
$V_{isol}$	AC, 1 min.	2500	V

Characteristics		$T_s = 25\text{ °C}$ , unless otherwise specified			
Symbol	Conditions	min.	typ.	max.	Units
<b>IGBT - Chopper</b>					
$V_{CEsat}$	$I_{Cnom} = 140\text{ A}$ , $T_j = 25\text{ (125) °C}$		1,7 (2)	2,1 (2,4)	V
$V_{GE(th)}$	$V_{GE} = V_{CE}$ , $I_C = 6\text{ mA}$	5	5,8	6,5	V
$V_{CE(TO)}$	$T_j = 25\text{ (125) °C}$		1 (0,9)	1,2 (1,1)	V
$r_T$	$T_j = 25\text{ (125) °C}$		5 (7,9)	6,4 (9,3)	mΩ
$C_{ies}$	$V_{CE} = 25\text{ V}$ , $V_{GE} = 0\text{ V}$ , $f = 1\text{ MHz}$		11,2		nF
$C_{oes}$	$V_{CE} = 25\text{ V}$ , $V_{GE} = 0\text{ V}$ , $f = 1\text{ MHz}$		1,9		nF
$C_{res}$	$V_{CE} = 25\text{ V}$ , $V_{GE} = 0\text{ V}$ , $f = 1\text{ MHz}$		1,5		nF
$R_{th(j-s)}$	per IGBT		0,3		K/W
$t_{d(on)}$	under following conditions		80		ns
$t_r$	$V_{CC} = 600\text{ V}$ , $V_{GE} = \pm 15\text{ V}$		40		ns
$t_{d(off)}$	$I_{Cnom} = 140\text{ A}$ , $T_j = 125\text{ °C}$		500		ns
$t_f$	$R_{Gon} = R_{Goff} = 5\text{ Ω}$		100		ns
$E_{on}$	inductive load		19,9		mJ
$E_{off}$			17,3		mJ
<b>Diode - Chopper</b>					
$V_F = V_{EC}$	$I_{Fnom} = 140\text{ A}$ , $T_j = 25\text{ (125) °C}$		1,5 (1,5)	1,7 (1,7)	V
$V_{(TO)}$	$T_j = 25\text{ (125) °C}$		1 (0,8)	1,1 (0,9)	V
$r_T$	$T_j = 25\text{ (125) °C}$		3,6 (5)	4,3 (5,7)	mΩ
$R_{th(j-s)}$	per diode		0,4		K/W
$I_{RRM}$	under following conditions		210		A
$Q_{rr}$	$I_{Fnom} = 140\text{ A}$ , $V_R = 600\text{ V}$		38		μC
$E_{rr}$	$V_{GE} = 0\text{ V}$ , $T_j = 125\text{ °C}$		16,2		mJ
	$di_F/dt = 4300\text{ A/μs}$				

Characteristics		$T_s = 25\text{ °C}$ , unless otherwise specified			
Symbol	Conditions	min.	typ.	max.	Units
<b>Diode - Rectifier</b>					
$V_F$	$I_{Fnom} = 90\text{ A}$ , $T_j = 25\text{ °C}$		1,2		V
$V_{(TO)}$	$T_j = 150\text{ °C}$		0,8		V
$r_T$	$T_j = 150\text{ °C}$		4		mΩ
$R_{th(j-s)}$	per diode		0,5		K/W
<b>Thyristor - Rectifier</b>					
$V_T$	$I_{Fnom} = 200\text{ A}$ , $T_j = 25\text{ (125) °C}$			1,65 (1,6)	V
$V_{T(TO)}$	$T_j = 125\text{ °C}$			0,9	V
$r_T$	$T_j = 125\text{ °C}$			3,5	mΩ
$V_{GT}$	$T_j = 25\text{ °C}$			3	V
$I_{GT}$	$T_j = 25\text{ °C}$	150			mA
$I_H$	$T_j = 25\text{ °C}$		150		mA
$I_L$	$T_j = 25\text{ °C}$		300		mA
$dv/dt_{(cr)}$	$T_j = 125\text{ °C}$			1000	V/μs
$di/dt_{(cr)}$	$T_j = 125\text{ °C}$			100	A/μs
$R_{th(j-s)}$	per thyristor		0,5		K/W
<b>Temperature Sensor</b>					
$R_{ts}$	3 %, $T_r = 25\text{ (100) °C}$		1000(1670)		Ω
<b>Mechanical Data</b>					
w			95		g
$M_s$	Mounting torque	2		2,5	Nm

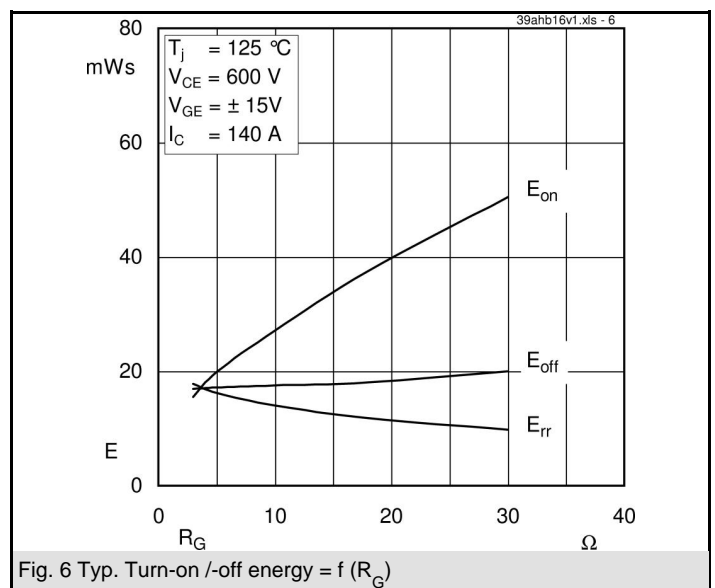
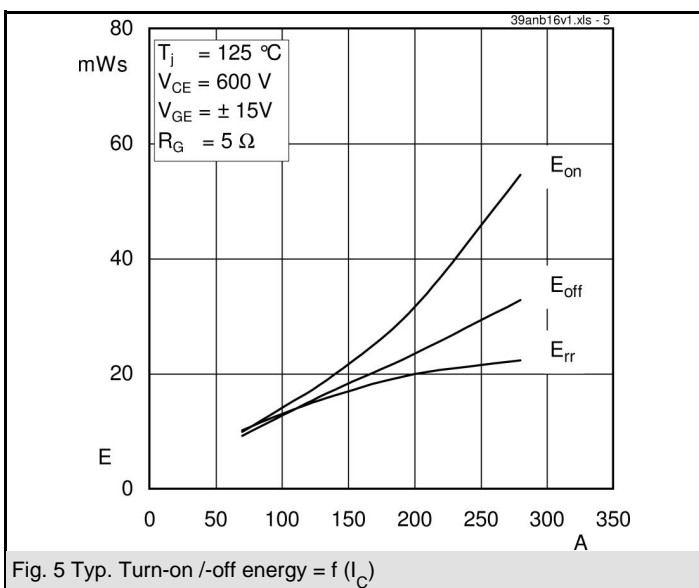
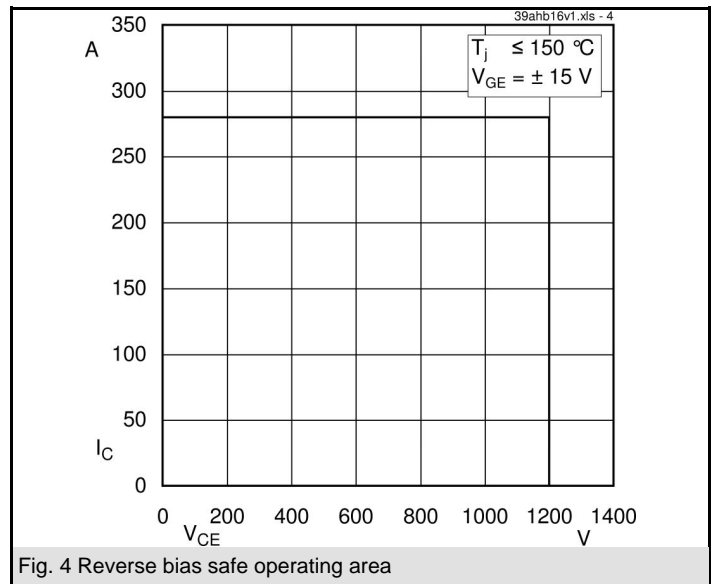
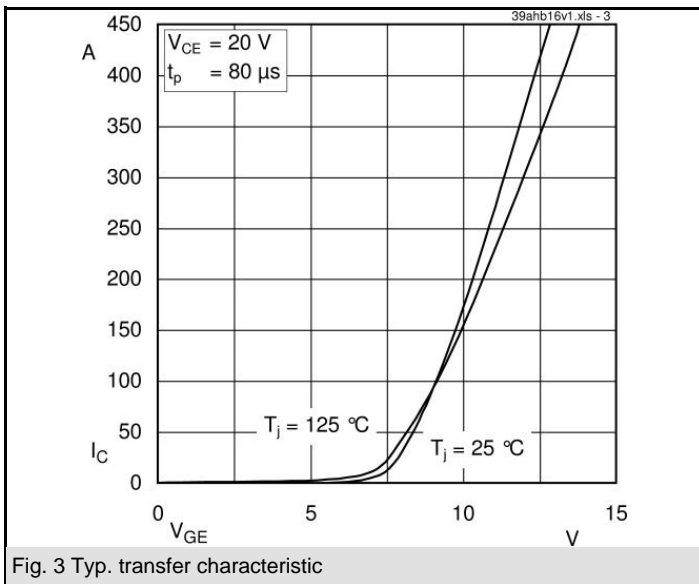
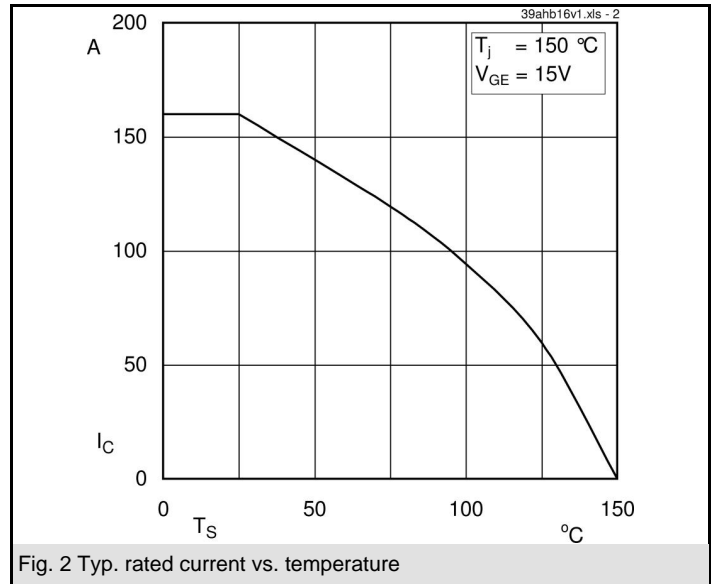
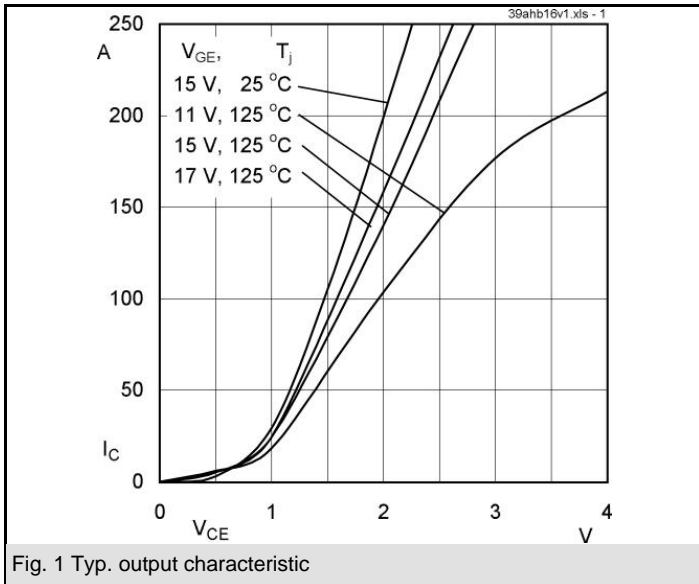

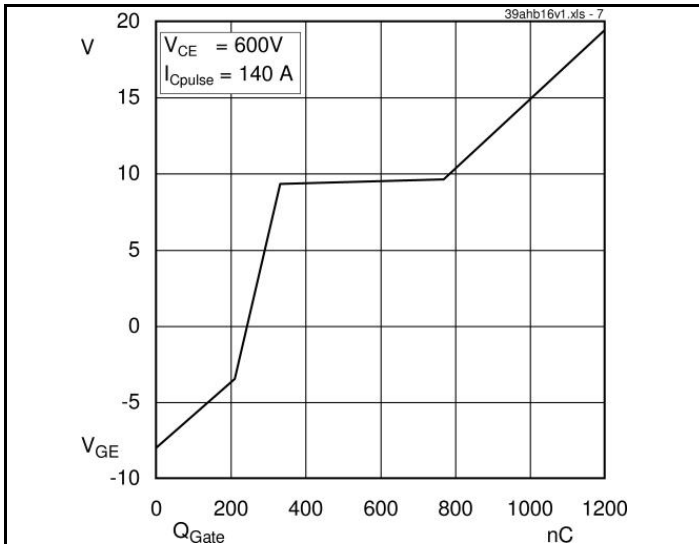

Fig. 7 Typ. gate charge characteristic

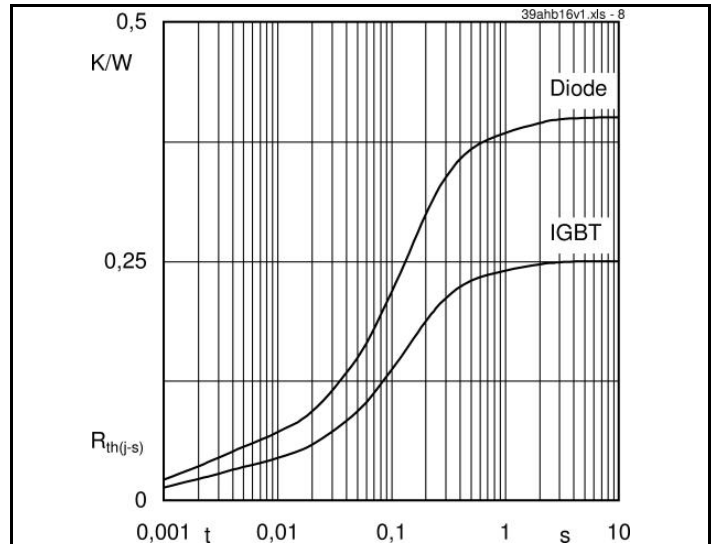

Fig. 8 Typ. thermal impedance

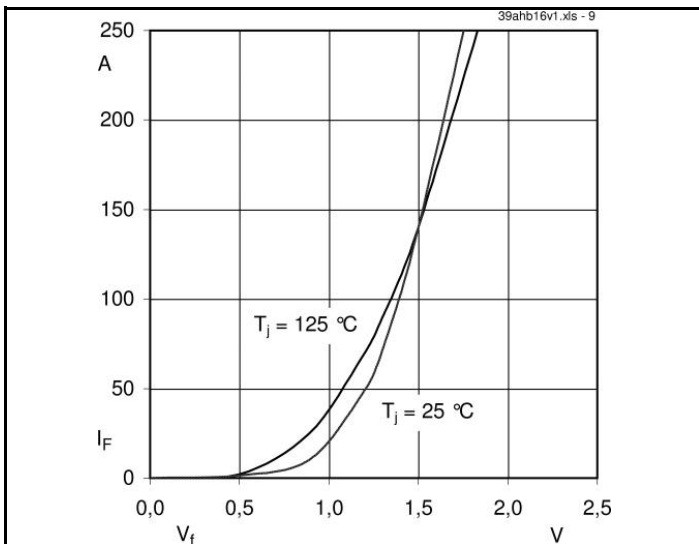

Fig. 9 Typ. freewheeling diode forward characteristic

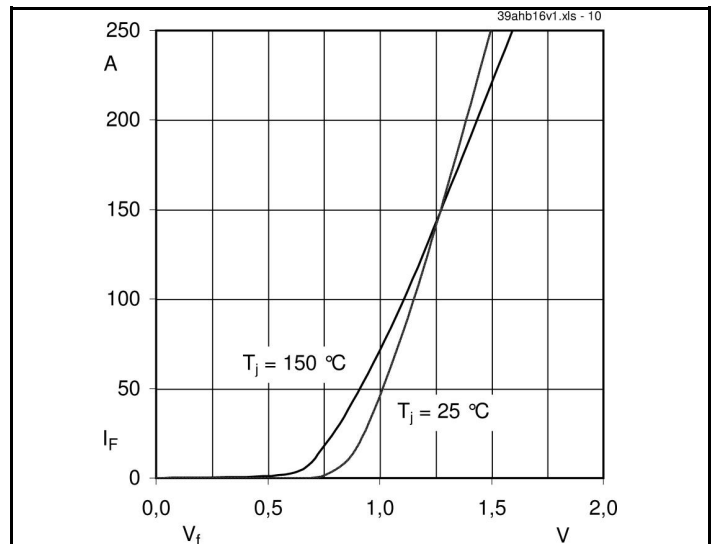

Fig. 10 Typ. input bridge forward characteristic

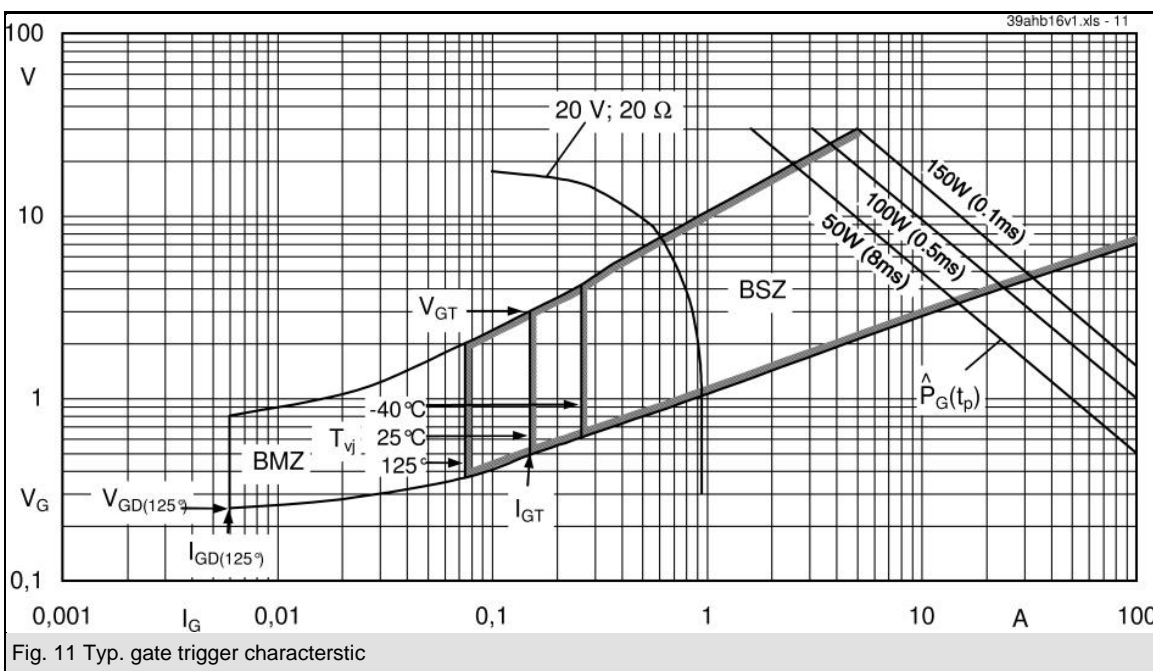
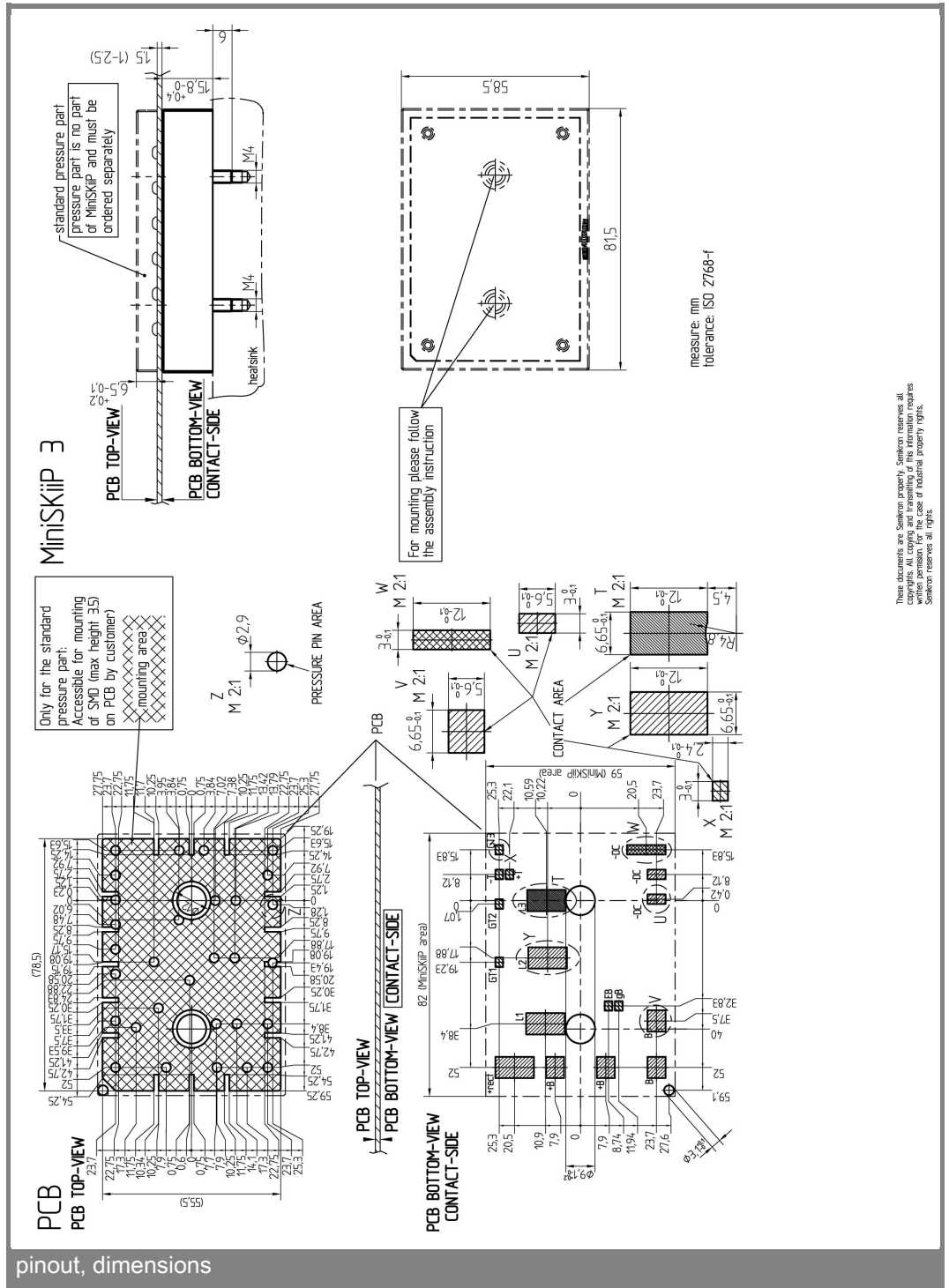
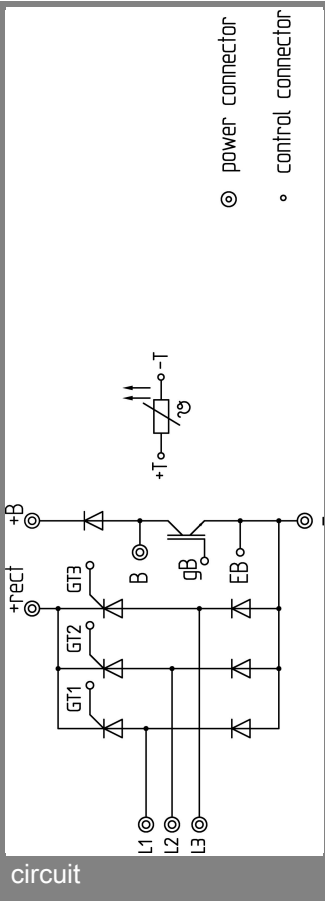

Fig. 11 Typ. gate trigger characteristic



These documents are Semikron property. Semikron reserves all copyrights. All copying and transferring of the information requires written permission. In the case of industrial property rights, Semikron reserves all rights.

This is an electrostatic discharge sensitive device (ESDS), international standard IEC 60747-1, Chapter IX.

This technical information specifies semiconductor devices but promises no characteristics. No warranty or guarantee expressed or implied is made regarding delivery, performance or suitability.