



LIGHTING FOREVER

Infrared Receiver Module

IRM-36xxM2 series

Features

- High protection ability against EMI
- Circular lens for improved reception characteristics
- Available for various carrier frequencies
- Min burst length: 10 cycles
- Min gap length: 14 cycles
- Low operating voltage and low power consumption
- High immunity against ambient light
- Long reception range
- High sensitivity
- Pb free and RoHS compliant

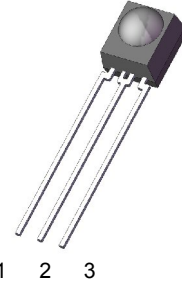

Description

The IRM-36xxM2 devices are DIP type infrared receivers which have been developed and designed by using the latest IC technology. The PIN diode and preamplifier are assembled onto a lead frame and molded into a black epoxy package which operates as an IR filter. The demodulated output signal can directly be decoded by a microprocessor.

Pin Configuration

1. OUT
2. GND
3. V_{CC}

Applications

- AV equipment such as TV, VCR, DVD, CD, MD, etc.
- CATV set top boxes
- Multi-media Equipment
- Other devices using IR remote control

Application Circuit

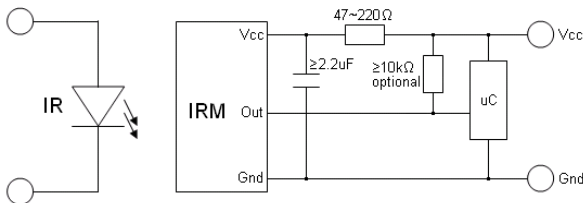

Block Diagram

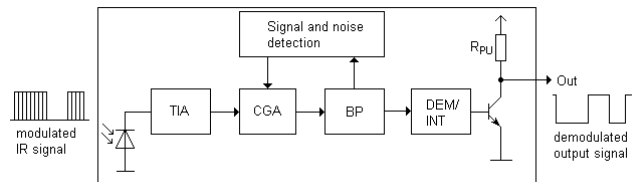

The RC Filter must be connected as close as possible to Vcc and GND pins.



LIGHTING FOREVER

Infrared Receiver Module

IRM-36xxM2 series

Parts Table

Model No.	Carrier Frequency
IRM-3636M2	36 kHz
IRM-3638M2	38 kHz
IRM-3640M2	40 kHz

Package Dimensions

(Dimensions in mm)

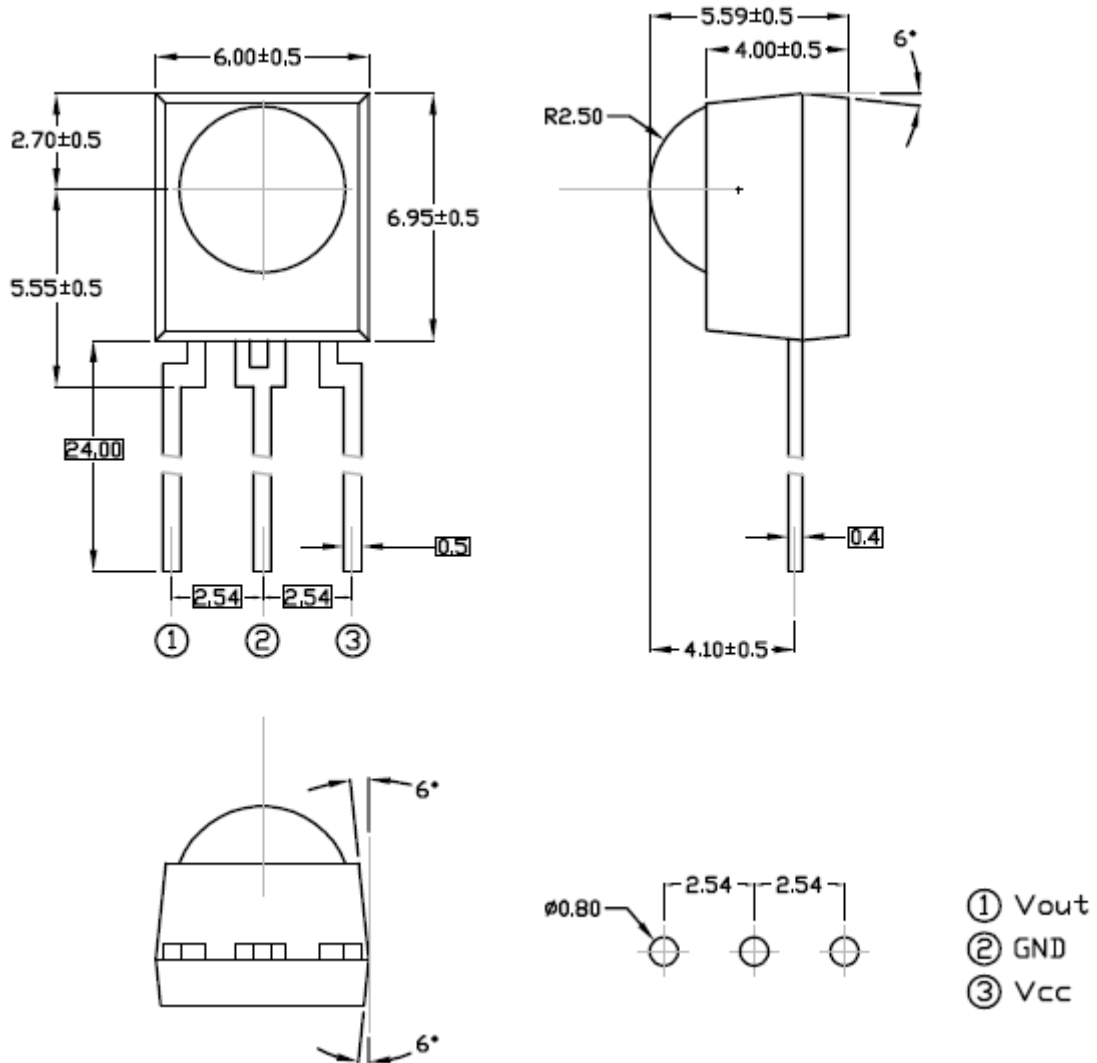



LIGHTING FOREVER

Infrared Receiver Module

IRM-36xxM2 series

Absolute Maximum Ratings (T_a=25°C)

Parameter	Symbol	Rating	Unit
Supply Voltage	V _{cc}	6	V
Operating Temperature	T _{opr}	-20 ~ +80	
Storage Temperature	T _{stg}	-40 ~ +85	
Soldering Temperature ^{*1}	T _{sol}	260	

^{*1} 4mm from mold body for less than 10 seconds

Electro-Optical Characteristics (T_a=25 , V_{cc}=3V)

Parameter	Symbol	MIN.	TYP.	MAX.	Unit	Condition
Current consumption	I _{cc}	---	0.4	0.6	mA	No input signal
Supply voltage	V _{CC}	2.7	-	5.5	V	
Peak wavelength	λ _p	---	940	---	nm	
Reception range	L ₀	14	---	---	m	See chapter ,Test method'
	L ₄₅	6	---	---		
Half angle(horizontal)	φ _h	---	±35	---	deg	
Half angle(vertical)	φ _v	---	±35	---	deg	
High level pulse width	T _H	450	---	700	μs	
Low level pulse width	T _L	500	---	750	μs	
High level output voltage	V _{OH}	V _{cc} -0.4	---	---	V	
Low level output voltage	V _{OL}	---	0.2	0.5	V	I _{SINK} 2mA
Internal pull up resistor	R _{PU}	85	100	115	kΩ	

Test method

The specified electro-optical characteristics are valid under the following conditions.

1. Measurement environment
 - A place without extreme light reflections.
2. External light
 - The environment contains an ordinary, white fluorescent lamp without high frequency modulation. The color temperature is 2856K and the illumination at the IR receiver is less than 10 Lux (Ev = 10Lux).
3. Standard transmitter
 - The test transmitter is calibrated by using the circuit shown in figure 2. The radiation intensity of the transmitter is adjusted until **Vo=400mVp-p**. Both, the test transmitter and the photo diode, have a peak wavelength of 940nm. The photo diode for calibration is PD438B ($\lambda_p=940\text{nm}$, $V_r=5\text{V}$).
4. The measurement system is shown in Fig.-3

Fig.-1 Transmitter Wave Form

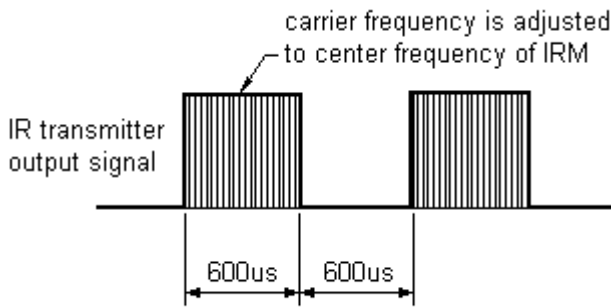

D.U.T output Pulse

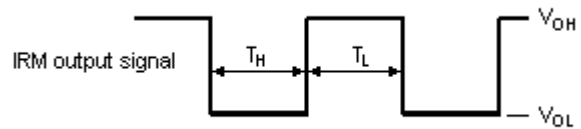

Fig.-2 standard transmitter calibration

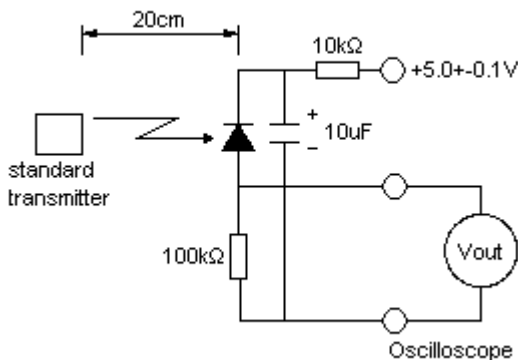
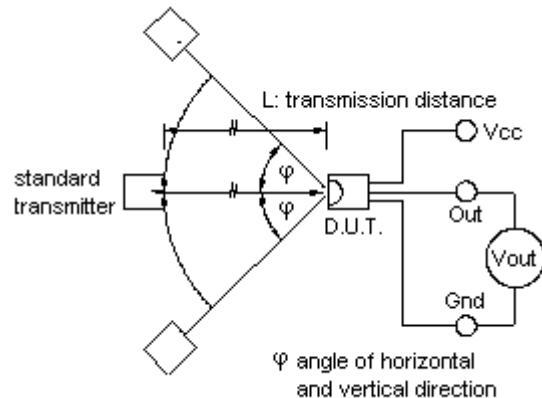

Fig.-3 Measuring System





LIGHTING FOREVER

Infrared Receiver Module

IRM-36xxM2 series

Typical Electro-Optical Characteristic Curves

Fig.4 Relative Responsibility vs. Wavelength

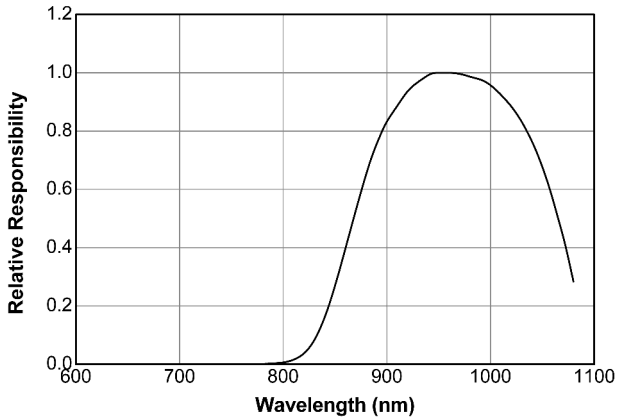

Fig.5 Relative Sensitivity vs. Angle

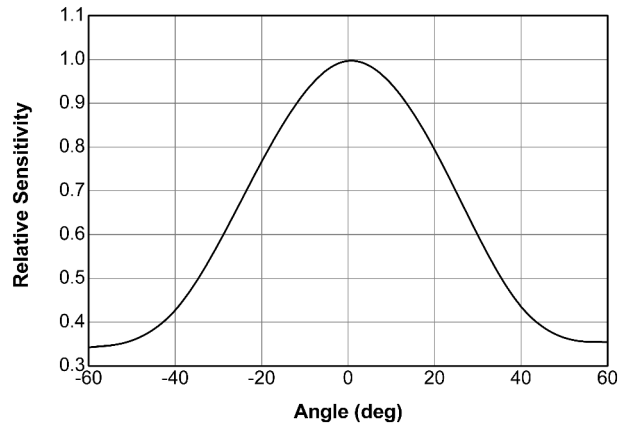

Fig.6 Variation Output Pulse Width vs. Distance

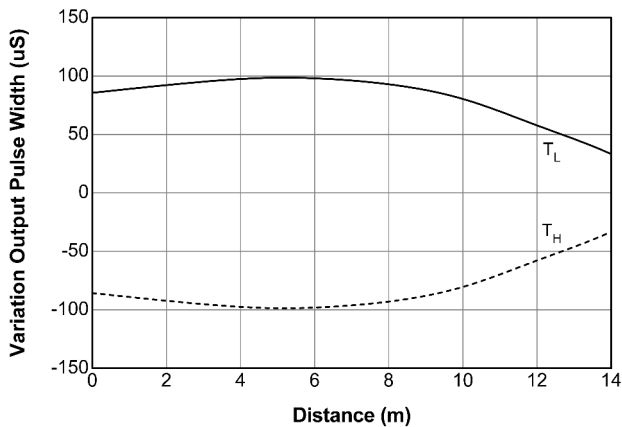

Fig.7 Supply Voltage vs. Distance

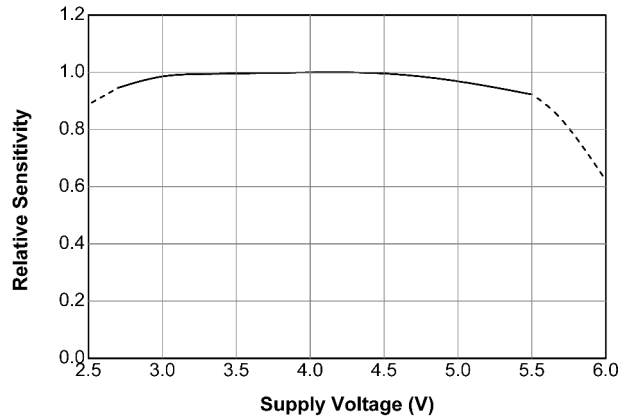
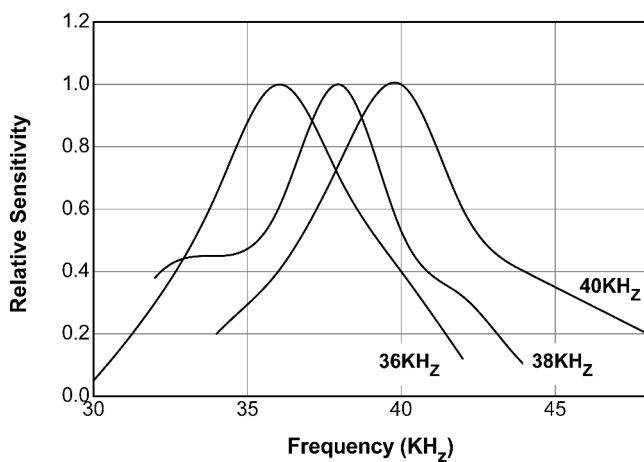

Fig.8 Relative Sensitivity vs. Frequency





LIGHTING FOREVER

Infrared Receiver Module

IRM-36xxM2 series

Code information

Protocol	Suitable	Protocol	Suitable
JVC	Yes	RCA	Yes
Matsushita	Yes	Sharp	Yes
Mitsubishi	Yes	Sony 12 Bit	Yes
NEC	Yes	Sony 15 Bit	Yes
RC5	Yes	Sony 20Bit	Yes
RC6	Yes	Toshiba	Yes
RCMM	No	Zenith	Yes
RCS-80	No	Continuous Code	No

Device Marking

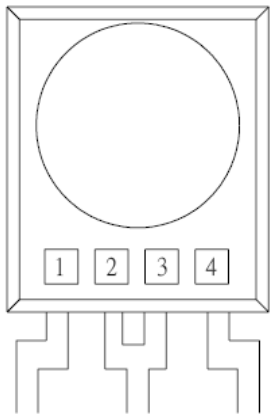

Notes

- 1 denotes Year code
- 2 denotes Month code
- 3 denotes Device number
- 4 denotes Carrier frequency



LIGHTING FOREVER

Infrared Receiver Module

IRM-36xxM2 series

Packing Quantity

1500 pcs / Box

10 Boxes / Carton

DISCLAIMER

1. Above specification may be changed without notice. EVERLIGHT will reserve authority on material change for above specification.
2. When using this product, please observe the absolute maximum ratings and the instructions for use outlined in these specification sheets. EVERLIGHT assumes no responsibility for any damage resulting from use of the product which does not comply with the absolute maximum ratings and the instructions included in these specification sheets.
3. These specification sheets include materials protected under copyright of EVERLIGHT. Reproduction in any form is prohibited without the specific consent of EVERLIGHT.