

## T-1<sup>3</sup>/<sub>4</sub> (5mm) Bi-Color Indicator Lamp

LTL- 298WJ Orange - Green

### Features

- Orange and Green chips are matched for uniform light output.
- T-1<sup>3</sup>/<sub>4</sub> type package.
- Long life solid state reliability.
- Low power consumption.
- I.C. compatible.

### Description

The Green/Orange LTL-298WJ bicolor lamp is a white diffused, wide viewing angle, dual chips, utilizing Gallium Phosphide on Gallium Phosphide Green Light Emitting Diode and Gallium Arsenide Phosphide on Gallium Phosphide Orange Light Emitting Diode. The dual chips operating dependently of each other.

### Package Dimensions

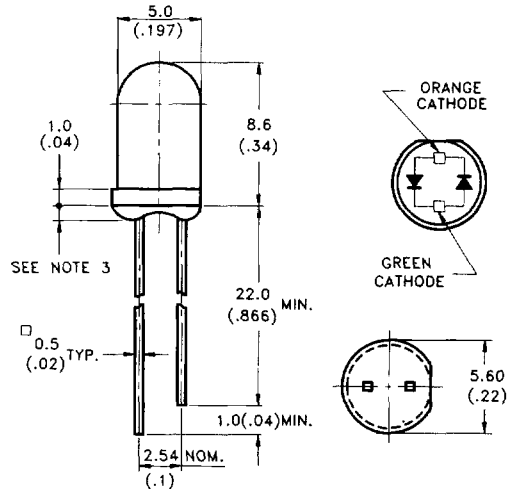

#### Notes:

1. All dimensions are in millimeters (inches).
2. Tolerance is  $\pm 0.25\text{mm}$  (.010") unless otherwise noted.
3. Protruded resin under flange is 1.0mm (.04") max.
4. Lead spacing is measured where the leads emerge from the package.
5. Specifications are subject to change without notice.

### Devices

Part No. LTL-	Lens		Source Color
	Color	Diffusion	
298WJ	White	Diffused	Green
			Orange

### Absolute Maximum Ratings at Ta=25 °C

Parameter	Green	Orange	Unit
Power Dissipation	100	100	mW
Peak Forward Current (1/10 Duty Cycle, 0.1ms Pulse Width)	120	120	mA
Continuous Forward Current	30	30	mA
Derating Linear From 50 °C	0.4	0.4	mA/ °C
Reverse Voltage	5	5	V
Operating Temperature Range	-55 °C to +100 °C		
Storage Temperature Range	-55 °C to +100 °C		
Lead Soldering Temperature [1.6mm (0.063in) From Body]	260 °C for 5 Seconds		

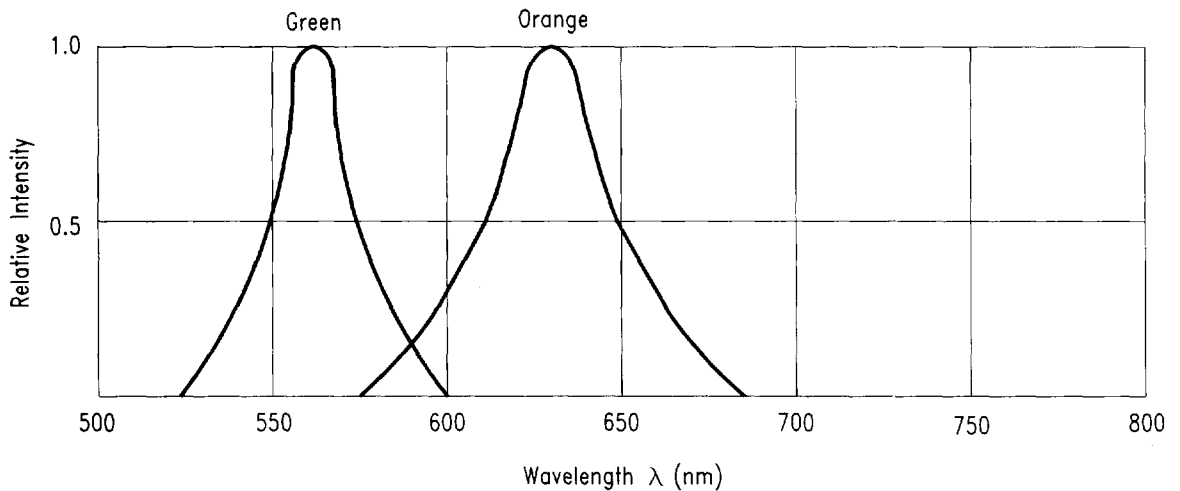

Fig.1 RELATIVE INTENSITY VS. WAVELENGTH

# Electrical / Optical Characteristics and Curves at Ta = 25 °C

Parameter	Symbol	Part No. LTL-298WJ	Min.	Typ.	Max.	Unit	Test Condition
Luminous Intensity	$I_v$	Orange Green	2.5 2.5	8.7 8.7		mcd	$I_F=20$ mA Note 1
Viewing Angle	$2\theta_{1/2}$	Orange Green		50		deg	Note 2 (Fig.6)
Peak Emission Wavelength	$\lambda_P$	Orange Green		630 565		nm	Measurement @Peak (Fig.1)
Dominant Wavelength	$\lambda_d$	Orange Green		621 569		nm	Note 3
Spectral Line Half Width	$\Delta\lambda$	Orange Green		40 30		nm	
Forward Voltage	$V_F$	Orange Green		2.0 2.1	2.8	V	$I_F=20$ mA
Reverse Current	$I_R$	Orange Green			100	$\mu$ A	$V_R=5$ V
Capacitance	C	Orange Green		20 35		PF	$V_F=0$ f=1MHZ

## Notes:

- Luminous intensity is measured with a light sensor and filter combination that approximates the CIE eye-response curve.
- $\theta_{1/2}$  is the off-axis angle at which the luminous intensity is half the axial luminous intensity.
- The dominant wavelength,  $\lambda_d$  is derived from the CIE chromaticity diagram and represents the single wavelength which defines the color of the device.

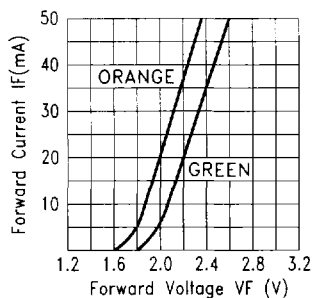

Fig.2 FORWARD CURRENT VS. FORWARD VOLTAGE

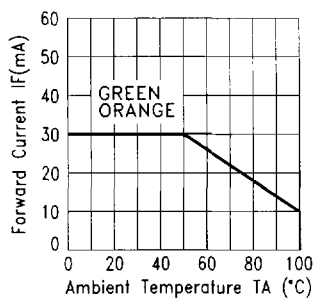

Fig.3 FORWARD CURRENT DERATING CURVE

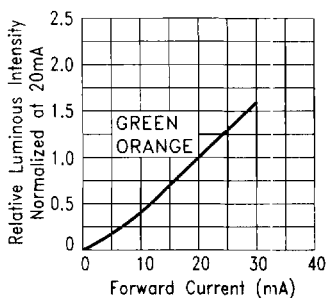

Fig.4 RELATIVE LUMINOUS INTENSITY VS. FORWARD CURRENT

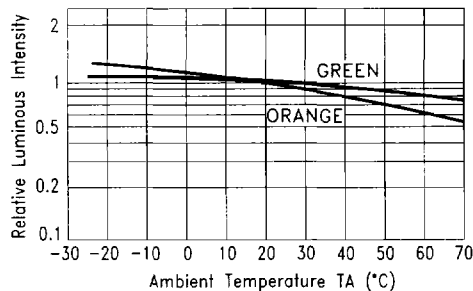

Fig.5 LUMINOUS INTENSITY VS. AMBIENT TEMPERATURE

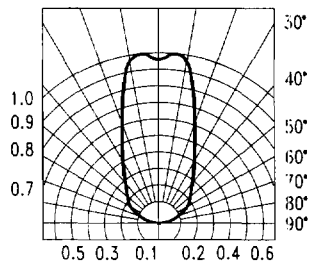

Fig.6 SPATIAL DISTRIBUTION