

# Rack & Panel

## XMRA & XMRE Series

**External Miniature Rectangular / #16 Contacts / .062" Dia.  
13 Amps ■ #20 Contacts / .040" Dia. / 7.5 Amps**

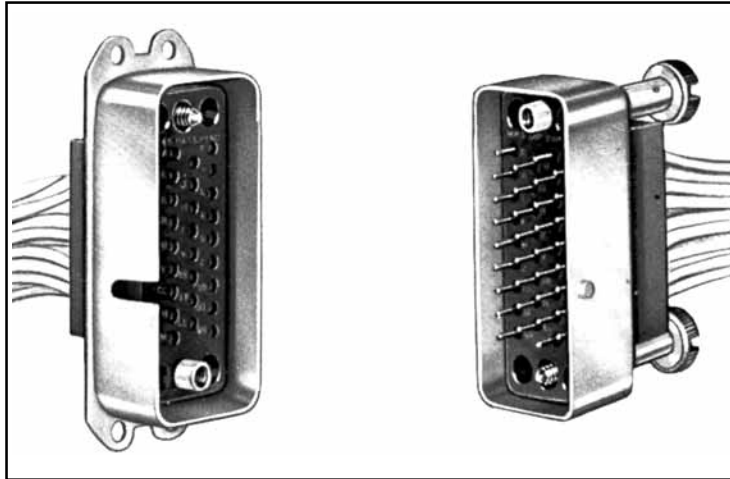

*A typical Series "XMRE" Receptacle and Plug fully wired and potted.*

The XMRE and XMRA Series connectors are designed to provide a sturdy, space-saving, lightweight electrical connection. Inserts are

housed in protective shells with screw lock coupling plus wall and cable mounting accessories available.

## SPECIFICATIONS

**Current Rating:** XMRA - 13 amps  
XMRE - 7.5 amps

**No. of Contacts:** XMRA - 9, 14, 20, 34, 42, 50, 50-8, 66, 75, 104  
XMRE - 9, 14, 18, 20, 26, 34, 42, 50, 75, 104

**Pin Contacts:** XMRA - .062 diameter, gold plated brass  
XMRE - .040 diameter, gold plated brass

**Socket Contacts:** Phosphor bronze plated gold.

**Termination Types:** XMRA - .070 dia. solder cup will accept up to #16 AWG stranded wire.  
XMRE - .048 dia. solder cup will accept up to #20 AWG stranded wire.

**Electrical Data:** Both XMRE and XMRA meet high potential performance requirements of MIL-C-28748. Military versions are QPL'd to M28748/1 and M28748/2 (XMRA) and to M28748/5 and M28748/6 (XMRE)  
The minimum dielectric withstanding voltage is one minute electrification at 1000 VAC (sea level) for XMRA and 1200 VAC for XMRE Series.

**Dielectric:** Brown mineral filled diallyl phthalate. Also available in gray glass filled diallyl phthalate, per MIL-M-14, SDG-F.

**Polarization:** A polarizing stud in the plug shell and a mating slot in the receptacle shell eliminates misalignment. Jackscrews and jacksockets or guide pins and sockets are alternative methods of polarization.

**Hoods:** Anodized Aluminum. May be applied to both plug and receptacles. Both top and side opening hoods are available.

# Rack & Panel

XMRA & XMRE Series

External Miniature Rectangular / #16 Contacts / .062" Dia.  
13 Amps ■ #20 Contacts / .040" Dia. / 7.5 Amps

## CONNECTOR ASSEMBLIES

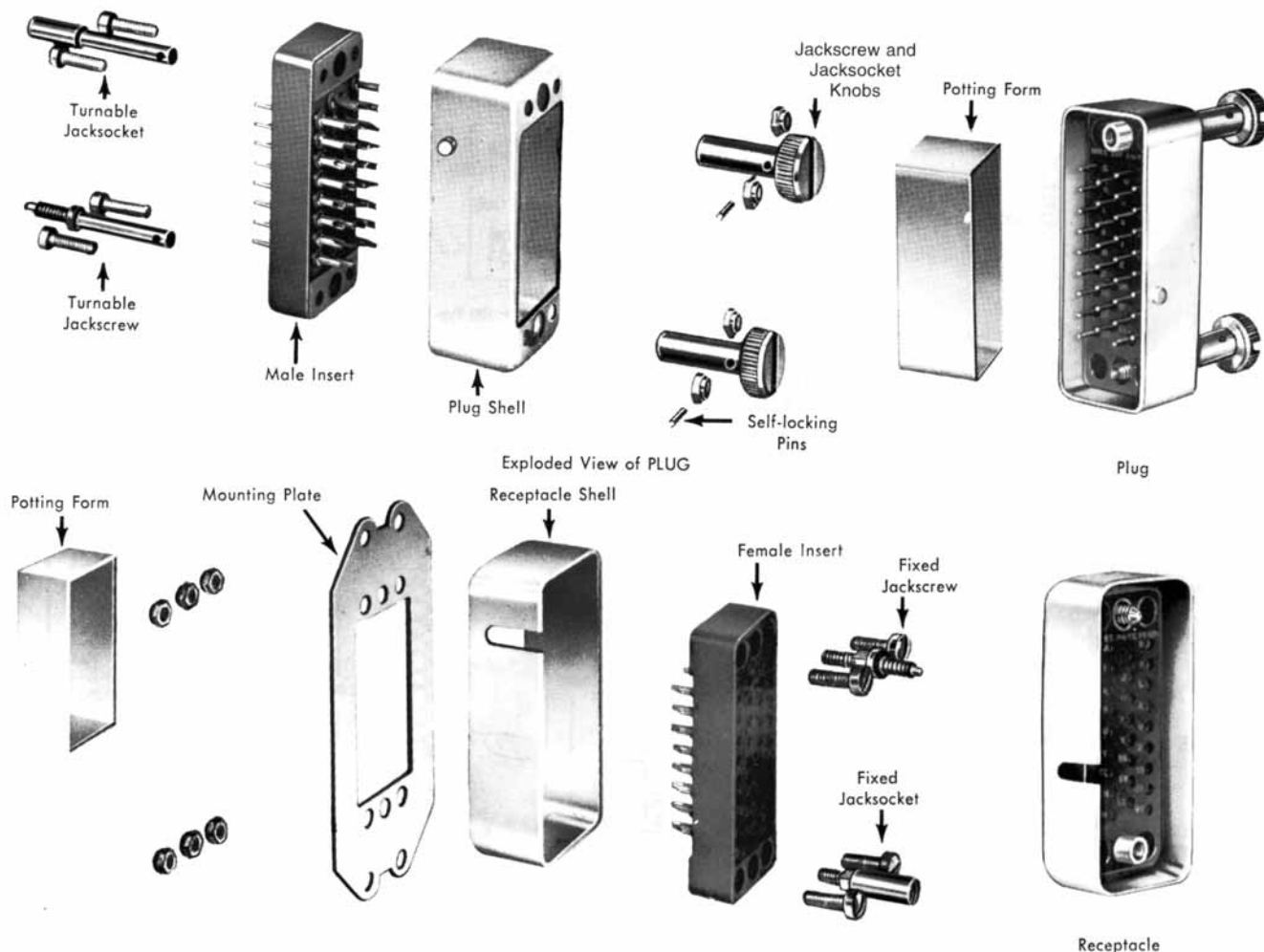

## CONNECTOR TERMS

**Plug:** The complete connector half which has the plug shell as part of its assembly.

**Receptacle:** The complete connector half which has the receptacle shell as part of its assembly.

**Shell:** The metal housing in which a male or female insert is assembled. A shell is either a plug shell or a receptacle shell.

**Plug Shell:** One which is designed to be inserted into a receptacle shell.

**Receptacle Shell:** One which is designed to receive and enclose the plug shell upon engagement.

**Male Insert:** The molded insulator body containing pin contacts.

**Female Insert:** The molded insulator body containing socket contacts.

**Pin Contacts:** Male metal conductors that fit into the socket contacts.

**Socket Contacts:** Female metal conductors, tubular in shape, which receive the pin contacts and retain them by spring tension.

**Polarization:** A means of controlling the engagement of a plug and receptacle so that correct mating of the contacts is achieved.

**Potting Form:** A plastic mold used to retain and shape the sealing compound during the moisture-proofing, or potting operation.

**Potting:** A method of moisture-proofing the back of a plug or receptacle and the soldered wire connections by injecting a free flowing sealing compound into a pre-shaped form and allowing it to set. The result is a homogeneous mass, chemically bonded to the back of the insert and around the soldered connections.

**Accessories:** Those components such as hoods, mounting plates and finger grips which are attachable to a plug or receptacle to facilitate mounting and/or handling of the connector.

Winchester/Retconn

62 Barnes Industrial Road North, Wallingford, Connecticut 06492 Phone:(203)741-5400 Fax:(203)741-5500 www.winchesterelectronics.com

# Rack & Panel

## XMRA & XMRE Series

External Miniature Rectangular / #16 Contacts / .062" Dia.  
 13 Amps ■ #20 Contacts / .040" Dia. / 7.5 Amps

### OUTLINE

Dimensions are for reference only and are subject to change. Outline drawings on request.

#### Contact Arrangements

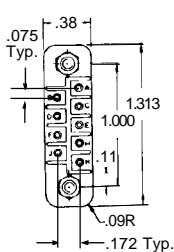

9 Contacts  
 XMRE 9 or XMRA 9

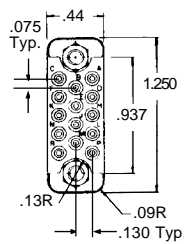

14 Contacts  
 XMRE 14 or XMRA 14

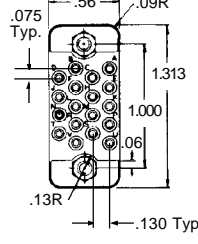

18 Contacts  
 XMRE 18

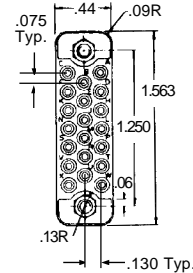

20 Contacts  
 XMRE 20 or XMRA 20

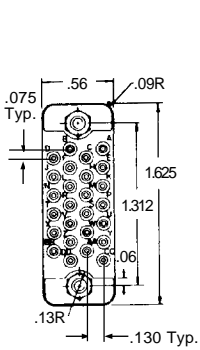

26 Contacts  
 XMRE 26

Mounting holes for No. 4 machine screws

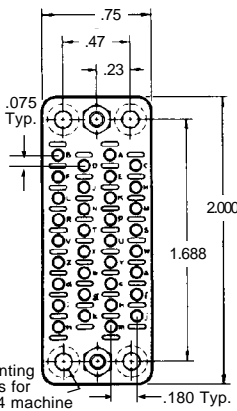

34 Contacts XMRA 34

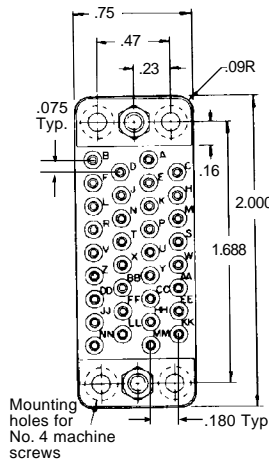

34 Contacts XMRE 34

Mounting holes for No. 4 machine screws

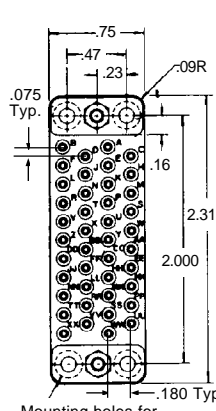

42 Contacts  
 XMRE 42 or XMRA 42

Mounting holes for No. 4 machine screws

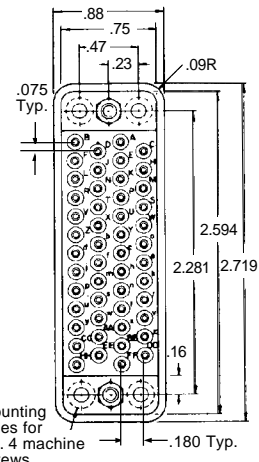

50 Contacts  
 XMRE 50 or XMRA 50

Mounting holes for No. 4 machine screws

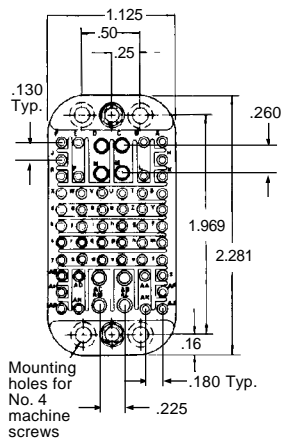

58 Contacts  
 XMRA 50-8

Mounting holes for No. 4 machine screws

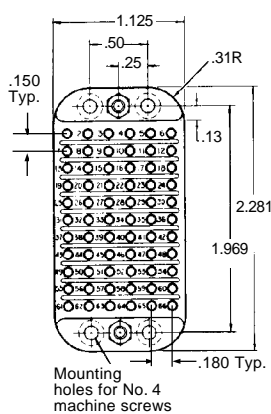

66 Contacts  
 XMRA 66

Mounting holes for No. 4 machine screws

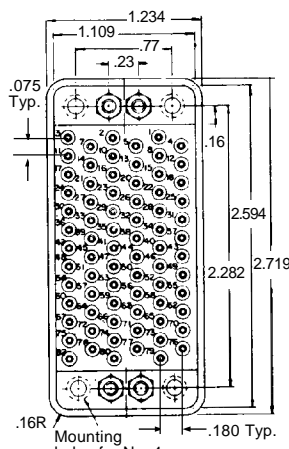

75 Contacts XMRE 75 or XMRA 75

Mounting holes for No. 4 machine screws

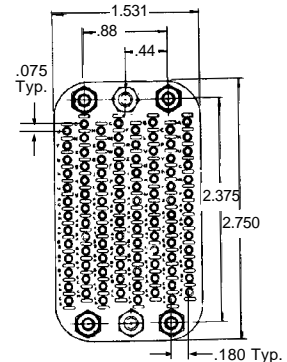

104 Contacts  
 XMRA 104  
 XMRE 104

Views are rear (wiring end) of female inserts (male inserts are mirror image). The spacing, arrangement, and identification of contacts of the XMRE inserts are the same as found on the Series MRE Connectors for the same number of contacts.

Winchester/Retconn

62 Barnes Industrial Road North, Wallingford, Connecticut 06492 Phone:(203)741-5400 Fax:(203)741-5500 www.winchesterelectronics.com

# Rack & Panel

## XMRA & XMRE Series

**External Miniature Rectangular / #16 Contacts / .062" Dia.  
13 Amps ■ #20 Contacts / .040" Dia. / 7.5 Amps**

## JACKSCREWS & JACKSOCKETS

### Jackscrew Locking Devices

Polarized jackscrews offer the ease and assurance of threaded positive coupling. They are particularly desirable for the larger connectors (XMRE 34 and larger) whenever they are to be used in locations that make it difficult to apply enough direct pull to separate the two halves of the connector.

Type C (long-turning jackscrews and jacksockets) or Type D (mono-jacks) must be specified if both jackscrews and hood are required on the same connector half. Monojacks eliminate the need for roll pins, spacers and washers.

## OUTLINE

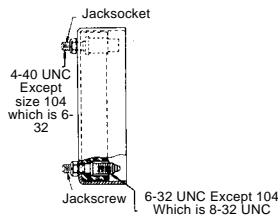

Connector with fixed Jackscrews  
Code designation: F

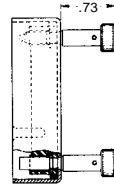

AND  
Mating connector half with turnable Jackscrews-with-Knobs  
Code designation: M

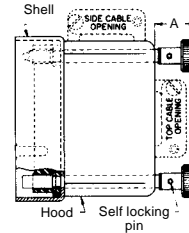

OR  
Mating connector half with Hood and turnable Long Jackscrews-with-Knobs

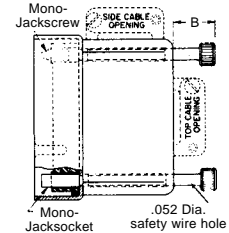

Code designation: C-0300, C-0400  
OR  
Mating connector half with Hood and turnable Monojacks  
Code designation: D-0300, D-0400

Drawings show extension of knobs beyond shell (left) and beyond hood. Refer to details of shells and hoods for the other dimensions which vary according to connector size.

## DIMENSIONS

### Dimension A

SERIES	CODE	9	14	18	20	26	34	42	50	50-8	66	75	104
XMRE	0300	-	-	-	-	.77	.58	.53	.53	-	-	.52	-
	0300X	.53	.53	.78	.53	.55	.58	.53	.53	-	-	.52	-
	0400	.55	.55	.55	.55	.55	.58	.53	.53	-	-	.52	-
	0400X	-	-	-	.55	.55	.58	.53	.53	-	-	.52	-
XMRA	0700	-	-	-	-	.58	-	-	.64	.64	-	.52	-
	0800	-	-	-	-	.58	-	-	.64	.64	-	.52	-

### Dimension B

CODE	34	42	50	66	75	104
0300	.59	.55	.55	-	.53	-
0400	.59	.55	.55	-	.53	-
0700	-	-	-	.38	-	.38
0800	-	-	-	.38	-	.38

Part	Code Letter	Wt. Oz. See Notes 1 & 2	Material and Finish
Jackscrews Jacksockets	Turntable M	0.30	stainless steel with passivating dip
Jackscrews Jacksockets	Long Turntable C	0.45	stainless steel with passivating dip
Jackscrews Jacksockets	Fixed F	0.15	nickel-plated brass
Knobs (except Monojacks)			al. anodized
Monojackscrews Monojacksockets	Turning Turning D		nickel-plated brass

Note 1: Weights are given for pairs, i.e., for a jackscrew and a jacksocket, etc., so that the weight figure may be added once to the weights of other accessories when computing the total weight of a plug or receptacle.

Note 2: Weights of turnable jackscrews and turnable jacksockets include knobs and roll pins; weights of fixed hardware include nuts.

Guide Socket Code Letter	Actual Size Photo	
G		G Type For General Use
K		K Type For High Electrical Conductivity Standard Guide Pin mates with all types
N		N Type For Extra Mechanical Strength

### MATERIALS

"G" Socket: Phosphor bronze.  
"K" Socket: Beryllium copper.  
"N" Socket: Brass.  
Guide Pin: Brass

### FINISH

Gold over Nickel

Winchester/Retconn

62 Barnes Industrial Road North, Wallingford, Connecticut 06492 Phone:(203)741-5400 Fax:(203)741-5500 www.winchesterelectronics.com

# Rack & Panel

## XMRA & XMRE Series External Miniature Rectangular / #16 Contacts / .062" Dia. 13 Amps ■ #20 Contacts / .040" Dia. / 7.5 Amps

### OUTLINE JACKSCREW & JACKSOCKETS

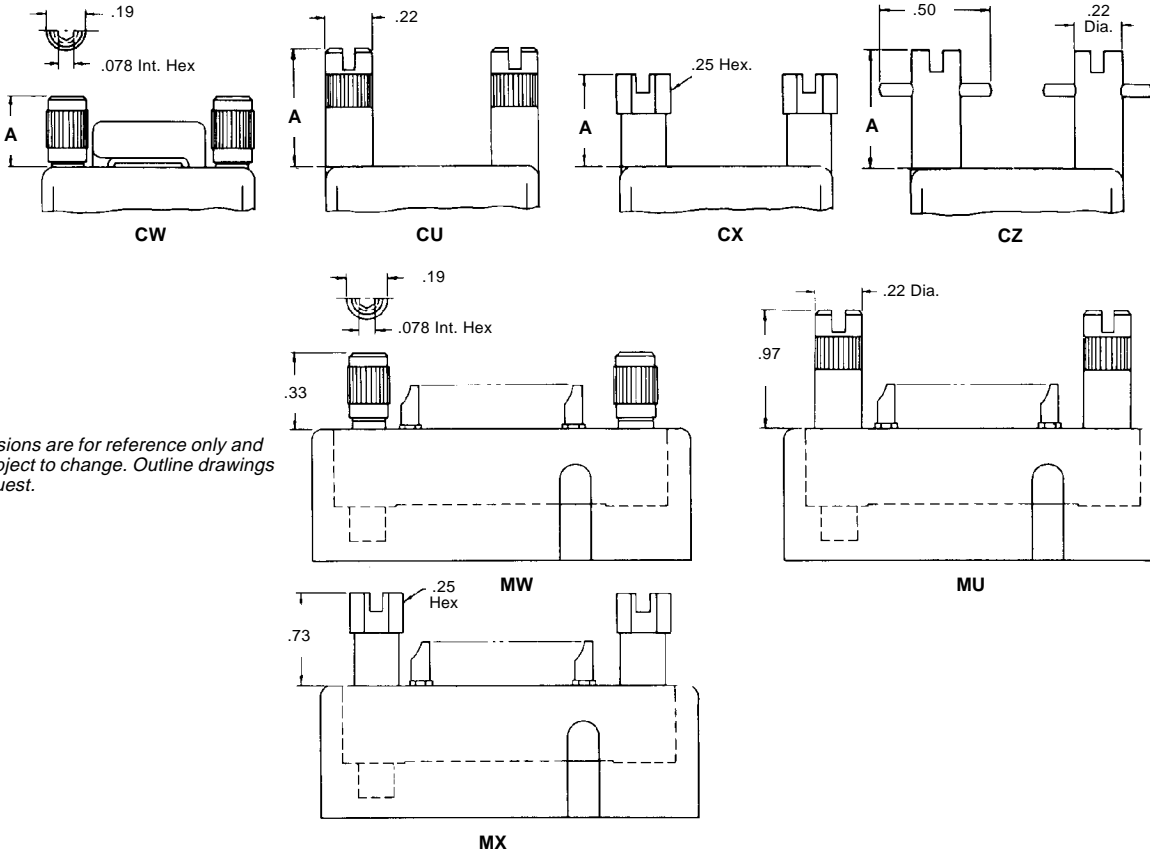

Dimensions are for reference only and are subject to change. Outline drawings on request.

### DIMENSIONS

All jackscREWS and sockets are stainless steel, passivated, except F & D which are nickel-plated brass.

All knobs are aluminum, anodized except MW and CW which are stainless steel, passivated.

### JackscREW Locking For Series XMRE, XMRA

Size	0300	0400	0300X	0400X	0700	0800	Size	0300	0400	0300X	0400X	0700	0800
Dimension A - Type CW						Dimension A - Type CU							
9	-	.36	.34	.36	-	-	9	-	.61	.59	.61	-	-
14	-	.36	.34	.36	-	-	14	-	.61	.59	.61	-	-
18	-	.36	.34	.36	-	-	18	-	.61	.59	.61	-	-
20	-	.36	.34	.36	-	-	20	-	.61	.59	.61	-	-
26	.36	.36	.36	.36	-	-	26	.61	.61	.61	.61	-	-
34	.39	.39	.39	.39	.47	.47	34	.64	.64	.64	.64	.72	.72
42	.34	.34	.34	.34	-	-	42	.59	.59	.59	.59	-	-
50	.34	.34	.34	.34	-	-	50	.59	.59	.59	.59	-	-
50-8	-	-	-	-	.47	.47	50-8	-	-	-	-	.72	.72
66	-	-	-	-	.47	.47	66	-	-	-	-	.72	.72
75	.33	.33	.33	.33	-	-	75	.58	.58	.58	.58	-	-
Size	0300	0400	0300X	0400X	0700	0800	Size	0300	0400	0300X	0400X	0700	0800
Dimension A - Type CX						Dimension A - Type CZ							
9	-	.48	.47	.48	-	-	9	-	.61	.59	.61	-	-
14	-	.48	.47	.48	-	-	14	-	.61	.59	.61	-	-
18	-	.48	.72	.48	-	-	18	-	.61	.84	.61	-	-
20	-	.48	.47	.48	-	-	20	-	.61	.59	.61	-	-
26	.77	.48	.48	.48	-	-	26	.92	.61	.61	.61	-	-
34	.52	.52	.52	.52	.61	.61	34	.64	.64	.64	.64	.72	.72
42	.47	.47	.47	.47	-	-	42	.59	.59	.59	.59	-	-
50	.47	.47	.47	.47	-	-	50	.59	.59	.59	.59	-	-
50-8	-	-	-	-	.61	.61	50-8	-	-	-	-	.72	.72
66	-	-	-	-	.61	.61	66	-	-	-	-	.72	.72
75	.45	.45	.45	.45	-	-	75	.58	.58	.58	.58	-	-

Winchester/Retconn

62 Barnes Industrial Road North, Wallingford, Connecticut 06492 Phone:(203)741-5400 Fax:(203)741-5500 www.winchesterelectronics.com



# Rack & Panel

## XMRA & XMRE Series

**External Miniature Rectangular / #16 Contacts / .062" Dia.**  
**13 Amps ■ #20 Contacts / .040" Dia. / 7.5 Amps**

### DIMENSIONS HOODS - DRAWN ALUMINUM

Dimensions are for reference only and are subject to change. Outline drawings on request.

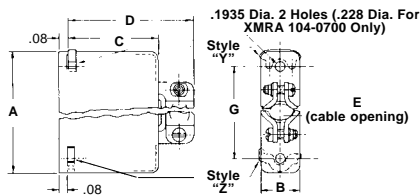

Top Cable Opening

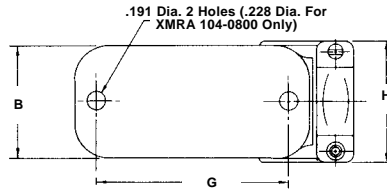

Side Cable Opening

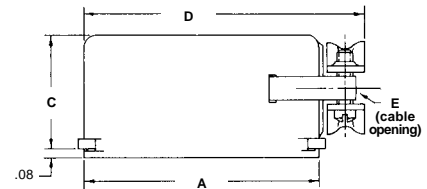

For use with	Hood Part Number	Dimensions					
		A	B	C	D	E	G
Type C Jacksockets & Jackscrews	XMRA 34-0700	2.09	.84	1.17	1.59	.66x.75	1.688
	XMRA 50-8-0700	2.38	1.22	1.17	1.69	1.03D	1.969
	XMRA 66-0700	2.38	1.22	1.17	1.69	1.03D	1.969
	XMRA 104-0700	2.84	1.63	2.23	2.75	1.19D	2.375
Type D Jacksockets & Jackscrews	XMRA 34-0700D	2.09	.84	1.17	1.59	.66x.75	1.688
	XMRA 50-8-0700D	2.38	1.22	1.17	1.69	1.03D	1.969
	XMRA 66-0700D	2.38	1.22	1.17	1.69	1.03D	1.969
	XMRA 104-0700D	2.84	1.63	2.23	2.75	1.19D	2.375
G, K, or N, Type Guides or Type F Jackscrews	XMRA 34-0900	2.09	.84	1.17	1.59	.66x.75	-
	XMRA 50-8-0900	2.38	1.22	1.17	1.69	1.03D	-
	XMRA 66-0900	2.38	1.22	1.17	1.69	1.03D	-
	XMRA 104-0900	2.84	1.63	2.23	2.75	1.19D	-

For use with	Hood Part Number	Dimensions						
		A	B	C	D	E	H	G
Type C Jacksockets & Jackscrews	XMRA 34-0800	2.09	.84	1.16	2.58	.64x.75	1.06	1.688
	XMRA 50-8-0800	2.38	1.22	1.16	2.91	.84 D	1.34	1.969
	XMRA 66-0800	2.38	1.22	1.16	2.91	.84D	1.34	1.969
	XMRA 104-0800	2.84	1.63	2.22	3.38	1.19D	1.63	2.375
Type D Jacksockets & Jackscrews	XMRA 34-0800D	2.09	.84	1.17	2.58	.64x.75	1.688	1.06
	XMRA 50-8-0800D	2.38	1.22	1.17	2.91	.84D	1.969	1.34
	XMRA 66-0800D	2.38	1.22	1.17	2.91	.84D	1.969	1.34
	XMRA 104-0800D	2.84	1.63	2.23	3.38	1.19D	2.375	1.63
G, K, or N, Type Guides or Type F Jackscrews	XMRA 34-0200	2.09	.84	1.16	2.58	.64x.75	1.06	-
	XMRA 50-8-0200	2.38	1.22	1.16	2.91	.84D	1.34	-
	XMRA 66-0200	2.38	1.22	1.16	2.91	.84D	1.34	-
	XMRA 104-0200	2.84	1.63	2.22	3.38	1.19D	1.63	-

### DIMENSIONS HOODS - FORMED ALUMINUM

For use with Monojacks	For use with Type C Jacksockets & Jackscrews	For use with G, K, or N, Type Guides *	Dimensions				Cable Opening		Wt. Oz.
			A	B	C	D	E Dia.	F Dia.	
	Hood Part No. (If ordered separately)								
		XMRE 9-0500	1	1.31	1.31	.44	.31	-	0.3
	XMRE 9-0300X	XMRE 9-0500X	1	1.30	1.31	.44	.59	.31	-
		XMRE 14-0500	.75	1.19	1.25	.5	.44D	-	0.3
	XMRE 14-0300X	XMRE 14-0500X	.75	1.05	1.25	.5	.59	.38	-
		XMRE 18-0500	.75	1.19	1.31	.63	.44D	-	0.4
	XMRE 18-0300X	XMRE 18-0500X	.75	1.25	1.31	.63	.63	.44	-
		XMRE 20-0500	.75	1.19	1.56	.5	.44D	-	0.3
	XMRE 20-0300X	XMRE 20-0500X	.75	1.05	1.56	.5	.66	.38	-
	XMRE 26-0300	XMRE 26-0500	1.28	1.72	1.63	.64	.59	.38	0.4
	XMRE 26-0300X	XMRE 26-0500X	1.28	1.78	1.63	.64	.78	.44	-
XMRE 34-0300D	XMRE 34-0300	XMRE 34-0500	1.25	1.67	2	.83	.66D	-	0.6
XMRE 34-0300XD	XMRE 34-0300X	XMRE 34-0500X	1.25	1.75	2.00	.83	1.06	.56	-
XMRE 42-0300D	XMRE 42-0300	XMRE 42-0500	1.30	1.73	2.31	.83	.63D	-	0.7
XMRE 42-0300XD	XMRE 42-0300X	XMRE 42-0500X	1.30	1.80	2.31	.83	1.06	.56	-
XMRE 50-0300D	XMRE 50-0300	XMRE 50-0500	1.30	1.80	2.59	.83	.63D	-	0.8
XMRE 50-0300XD	XMRE 50-0300X	XMRE 50-0500X	1.30	1.80	2.59	.83	1.06	.28	-
XMRE 75-0300D	XMRE 75-0300	XMRE 75-0500	1.31	1.75	2.59	1.19	.63	.88	1.0
XMRE 75-0300XD	XMRE 75-0300X	XMRE 75-0500X	1.31	1.86	2.59	1.19	1	.88	-

Top Cable Opening

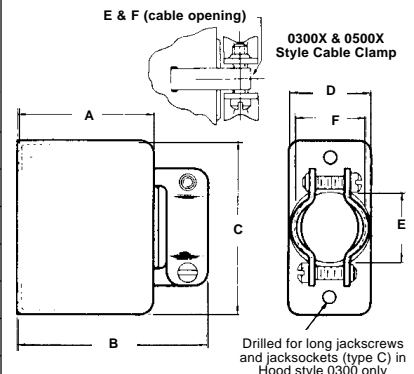

For use with Monojacks	For use with Type C Jacksockets & Jackscrews	For use with G, K, or N, Type Guides *	Dimensions				Cable Opening		Wt. Oz.
			A	B	C	D	E Dia.	F Dia.	
	Hood Part No. (If ordered separately)								
		XMRE 9-0600	1.28	1.31	1.63	.44	.31D	-	0.3
	XMRE 9-0400X	XMRE 9-0600X	1.28	1.31	1.61	.44	.59	.31	-
		XMRE 14-0600	1.28	1.25	1.69	.5	.38D	-	0.3
	XMRE 14-0400X	XMRE 14-0600X	1.28	1.25	1.55	.5	.59	.38	-
		XMRE 18-0600	1.28	1.31	1.75	.63	.44D	-	0.3
	XMRE 18-0400X	XMRE 18-0600X	1.28	1.31	1.81	.63	.69	.44	-
	XMRE 20-0400	XMRE 20-0600	1.28	1.56	2	.5	.38D	-	0.3
	XMRE 20-0400X	XMRE 20-0600X	1.28	1.56	1.86	.5	.66	.38	-
	XMRE 26-0400	XMRE 26-0600	1.28	1.63	2.06	.64	.59	.38	0.4
	XMRE 26-0400X	XMRE 26-0600X	1.28	1.63	2.13	.64	.78	.44	-
XMRE 34-0400D	XMRE 34-0400	XMRE 34-0600	1.25	2	2.42	.83	.66	-	0.6
XMRE 34-0400XD	XMRE 34-0400X	XMRE 34-0600X	1.25	2	2.5	.83	.81	.56	-
XMRE 42-0400D	XMRE 42-0400	XMRE 42-0600	1.30	2.31	2.73	.83	.63	.5	0.7
XMRE 42-0400XD	XMRE 42-0400X	XMRE 42-0600X	1.30	2.31	2.81	.83	.84	.56	-
XMRE 50-0400D	XMRE 50-0400	XMRE 50-0600	1.30	2.59	3.02	.83	.63	.5	0.8
XMRE 50-0400XD	XMRE 50-0400X	XMRE 50-0600X	1.30	2.59	3.09	.83	1.06	.56	-
XMRE 75-0400D	XMRE 75-0400	XMRE 75-0600	1.31	2.59	3.02	1.19	.63	.88	1.0
XMRE 75-0400XD	XMRE 75-0400X	XMRE 75-0600X	1.31	2.59	3.14	1.19	1	.88	-

Side Cable Opening

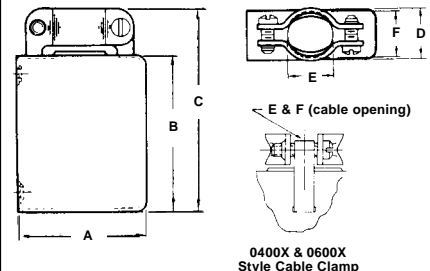

\* Add "J" to hood P/N when used with "F" jackscrews.

## Winchester/Retconn

62 Barnes Industrial Road North, Wallingford, Connecticut 06492 Phone:(203)741-5400 Fax:(203)741-5500 www.winchesterelectronics.com

# Rack & Panel

## XMRA & XMRE Series

## External Miniature Rectangular / #16 Contacts / .062" Dia. 13 Amps ■ #20 Contacts / .040" Dia. / 7.5 Amps

### OUTLINE SHELLS - RECEPTACLE

Dimensions are for reference only and are subject to change. Outline drawings on request.

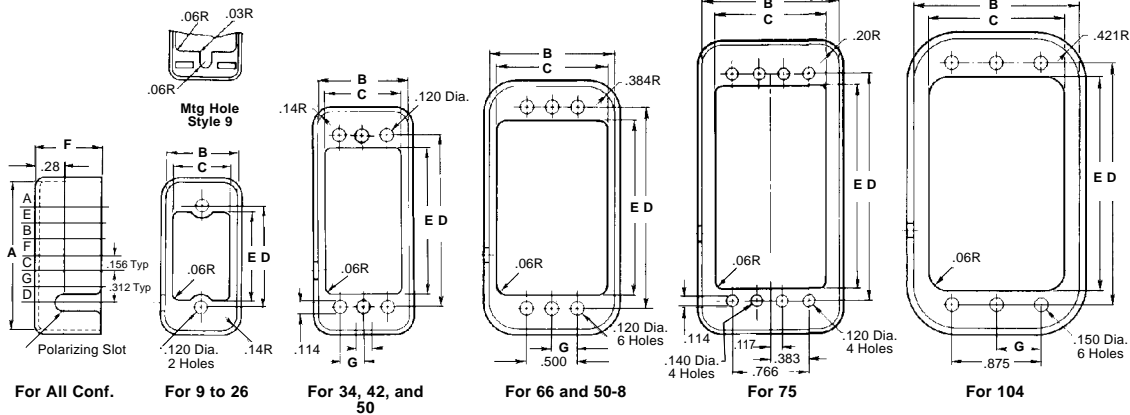

### DIMENSIONS SHELLS - RECEPTACLE

#### Important Note When Ordering Plug and Receptacle Shells

The shell part numbers given in table show an asterisk (\*) where the code letter for the desired polarizing position belongs - example: XMRE9-2\*000 becomes XMRE9-2B000 when polarization in position "B" is desired. Specify the same position on the mating shell.

For non-polarized shells, merely omit this position, e.g. XMRE9-2000.

#### TYPICAL SHELLS FOR MONOJACKS

Shells are aluminum, anodized for protection against corrosion. Either shell style - plug or receptacle - may be used to house the female insert, thus allowing the "live" socket contacts to be cable or panel mounted, as desired. Shells also provide a means by which connector polarization is accomplished - the receptacle shell is slotted for engaging a polarizing pin on the plug shell. Any of seven positions (A, B, C, D, E, F, or G) may be specified for polarization; non-polarized shells have the slot and pin omitted.

Stainless steel shells available for 66 and 104 sizes. Dimensions vary from those shown for aluminum shells, Check Sales for availability and dimensions on all sizes.

Shell Part No. (if ordered separately)	Dimensions							Wt. Oz.
	A	B	C	D	E	F	G	
XMRE 9-2*000	1.45	.52	.38	1.000	.88	.66	-	0.15
XMRE 14-2*000	1.39	.58	.45	.937	.81	.66	-	0.16
XMRE 18-2*000	1.45	.70	.58	1.000	.88	.66	-	0.17
XMRE 20-2*000	1.70	.58	.45	1.250	1.13	.66	-	0.19
XMRE 26-2*000	1.77	.70	.58	1.312	1.19	.66	-	0.23
XMRE 34-2*000	2.14	.89	.75	1.687	1.44	.66	.234	0.25
XMRE 42-2*000	2.45	.89	.75	2.000	1.75	.66	.234	0.28
XMRE 50-2*000	2.86	1.02	.75	2.282	2.03	.66	.234	0.30
XMRA 66-2*000								
XMRA 66-4*000								
XMRA 50-8-2*000	2.42	1.27	1.13	1.969	1.72	.66	.250	0.28
XMRE 75-2*000	2.86	1.38	1.11	2.282	2.03	.66	-	0.32
XMRE 75-4*000	2.86	1.38	1.11	2.282	2.03	.66	-	0.32
XMRA 104-2*000	2.91	1.69	1.48	2.375	2.13	.66	.437	0.30
XMRA 104-4*000	2.91	1.69	1.48	2.375	2.13	.66	.437	0.30

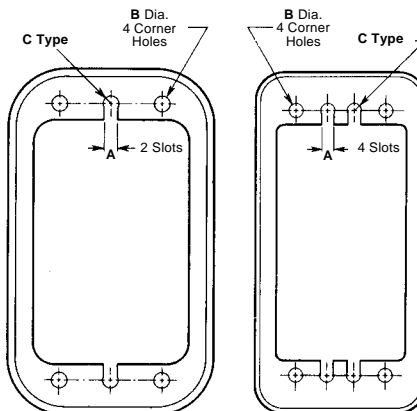

For 34, 42, 50, 50-8, 66  
and 104 Configuration

For 75  
Configuration

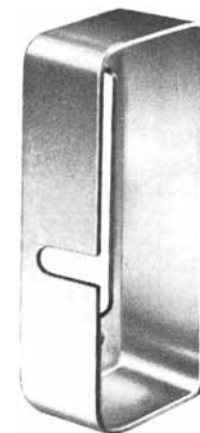

Receptacle Shell  
Style Number 2000

For Connector Size	A	B	C
34, 42, 50, 50-8, 66, 75	.11	.120	.06R
104	.14	.150	.07R

Shells are .040 in. thick.

Winchester/Retconn

62 Barnes Industrial Road North, Wallingford, Connecticut 06492 Phone:(203)741-5400 Fax:(203)741-5500 www.winchesterelectronics.com

# Rack & Panel

## XMRA & XMRE Series

External Miniature Rectangular / #16 Contacts / .062" Dia.  
 13 Amps ■ #20 Contacts / .040" Dia. / 7.5 Amps

### OUTLINE SHELLS - PLUG

Dimensions are for reference only and are subject to change. Outline drawings on request.

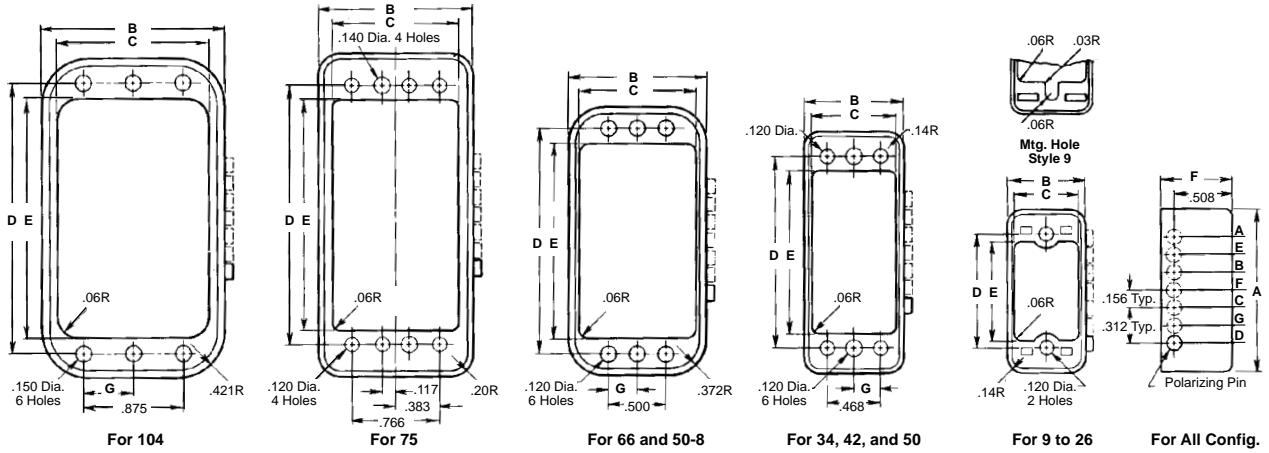

### DIMENSIONS

Shell Part No. (if ordered separately)	Dimensions							Wt. Oz.
	A	B	C	D	E	F	G	
XMRE 9-1*000	1.44	.5	.38	1.000	.88	.63	-	0.14
XMRE 14-1*000	1.38	.56	.45	.937	.81	.63	-	0.15
XMRE 18-1*000	1.44	.69	.58	1.000	.88	.63	-	0.16
XMRE 20-1*000	1.69	.56	.45	1.250	1.13	.63	-	0.18
XMRE 26-1*000	1.75	.69	.58	1.312	1.19	.63	-	0.22
XMRE 34-1*000								
XMRE 34-3*000	2.13	.88	.75	1.687	1.44	.66	.234	0.24
XMRE 42-1*000								
XMRE 42-3*000	2.44	.88	.75	2.000	1.75	.66	.234	0.26
XMRE 50-1*000								
XMRE 50-3*000	2.84	1	.75	2.282	2.03	.66	.234	0.28
XMRA 66-1*000								
XMRA 66-3*000	2.41	1.25	1.13	1.969	1.72	.66	.250	0.28
XMRA 50-8-1*000								
XMRA 50-8-3*000								
XMRE 75-1*000								
XMRE 75-3*000	2.84	1.36	1.11	2.282	2.03	.66	-	0.30
XMRA 104-1*000								
XMRA 104-3*000	2.88	1.66	1.48	2.375	2.13	.66	.437	0.30

### Typical Shells For Monojacks

For Connector Size	A	B	C
34, 42, 50, 50-8, 66, 75	.11	.120	.06R
104	.14	.150	.07R

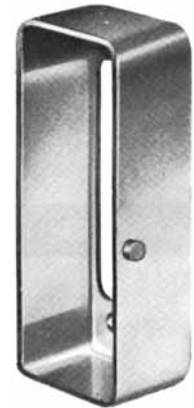
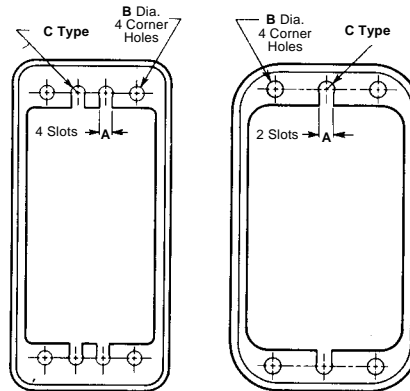

Plug Shell Style Number 1000

Shells are .040 in. thick.

Winchester/Retconn

62 Barnes Industrial Road North, Wallingford, Connecticut 06492 Phone:(203)741-5400 Fax:(203)741-5500 www.winchesterelectronics.com



# Rack & Panel

## XMRA & XMRE Series External Miniature Rectangular / #16 Contacts / .062" Dia. 13 Amps ■ #20 Contacts / .040" Dia. / 7.5 Amps

### OUTLINE MOUNTING PLATES

Dimensions are for reference only and are subject to change. Outline drawings on request.

#### Mounting Plates for External Miniature Rectangular Connectors, Potting Forms

Mounting Plates enable attachment of a connector to a wall, bulkhead, or other supporting surface. The plate is assembled to the back of a plug or receptacle by employing the same hardware and/or guides used to retain the insert in the shell; No. 4 machine screws are then used to mount the complete assembly against the required surface.

Mounting plates are aluminum, anodized to resist corrosion.

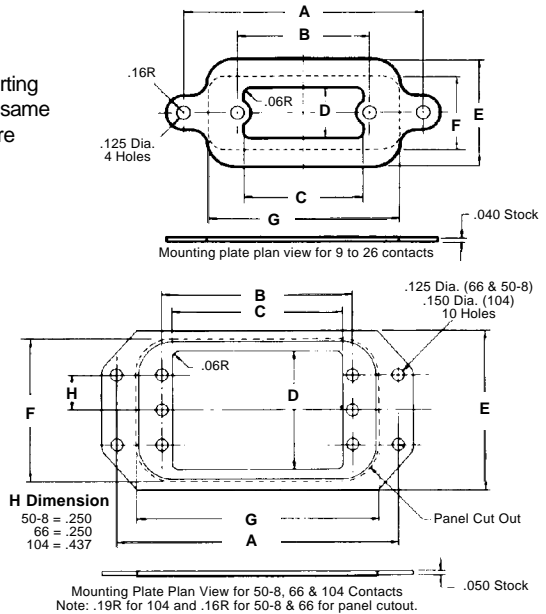
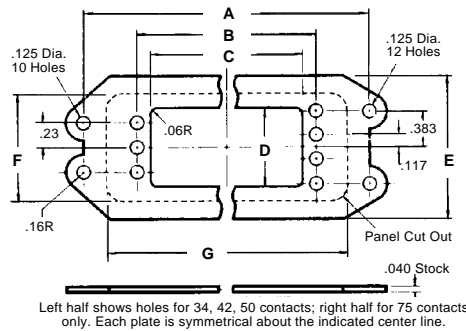

### DIMENSIONS

Mounting Plate Part No. (If Ordered Separately)	Dimensions							Panel Cutout	Wt.
	A	B	C	D	E	F	G	Oz.	
XMRE 9-0010	2.02	1.000	.88	.41	.95	.64	1.58	0.09	
XMRE 14-0010	1.95	.937	.81	.47	1.02	.70	1.52	0.10	
XMRE 18-0010	2.02	1.000	.88	.59	1.14	.83	1.58	0.11	
XMRE 20-0010	2.27	1.250	1.13	.47	1.02	.70	1.83	0.12	
XMRE 26-0010	2.33	1.312	1.19	.59	1.14	.83	1.89	0.14	
XMRE 34-0010	2.70	1.687	1.44	.75	1.33	1.02	2.27	0.15	
XMRE 42-0010	3.02	2.000	1.75	.75	1.33	1.02	2.58	0.16	
XMRE 50-0010	3.42	2.281	2.03	.75	1.45	1.14	2.98	0.18	
XMRE 75-0010	3.42	2.281	2.03	1.11	1.80	1.48	2.98	0.19	
XMRA 50-8-0010	2.98	1.969	1.72	1.13	1.69	1.39	2.55	0.18	
XMRA 66-0010									
XMRA 104-0010	3.5	2.375	2.13	1.48	2.0	1.81	3.03	0.19	

### OUTLINE POTTING FORMS

#### Potting Forms for External Miniature Rectangular Connectors

Nylon Potting Forms: Each form matches the back opening contour of its appropriate shell. Stays easily in place during the potting operation. Of negligible weight, the form need not be removed from the connector after potting. XMRE and XMRA connector-halves should always be engaged during the potting operation to preserve the contact alignment.

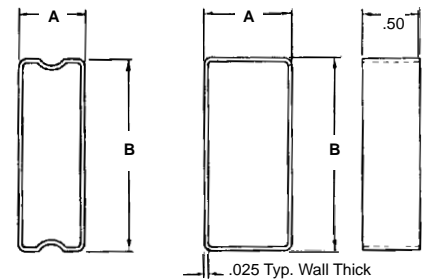

Potting form plan view for 9 to 26 contacts

Potting form plan view for 34, 42, 50, 50-8, 66, and 104 contacts

### DIMENSIONS

Potting Form Part No. (If Ordered Separately)	Dimensions	
	A	B
XMRE 9-0100	.38	.86
XMRE 14-0100	.45	.81
XMRE 18-0100	.56	.86
XMRE 20-0100	.44	1.11
XMRE 26-0100	.56	1.17
XMRE 34-0100	.75	1.39
XMRE 42-0100	.75	1.69
XMRE 50-0100	.75	1.98
XMRE 75-0100	1.11	1.98

Potting Form Part No. (If Ordered Separately)	Dimensions	
	A	B
XMRA 9-0100	.38	.86
XMRA 14-0100	.45	1.11
*XMRA 20-0100	.44	1.11
XMRA 34-0100	.75	1.39
XMRA 42-0100	.75	1.69
XMRA 50-0100	.75	2.03
XMRA 50-8-0100	1.13	1.72
XMRA 66-0100	1.13	1.72
XMRA 75-0100	1.11	2.03
XMRA 104-0100	1.48	2.08

\*Stepped construction not shown or dimensioned. Cut-outs to clear XMRA barriers not shown.

Winchester/Retconn

62 Barnes Industrial Road North, Wallingford, Connecticut 06492 Phone:(203)741-5400 Fax:(203)741-5500 www.winchesterelectronics.com

# Rack & Panel

## XMRA & XMRE Series

## External Miniature Rectangular / #16 Contacts / .062" Dia. 13 Amps ■ #20 Contacts / .040" Dia. / 7.5 Amps

### ORDERING INFORMATION

Omit steps not required

<b>XMRE 34</b>	<b>S</b>		<b>-F</b>	<b>-2</b>	<b>A</b>	<b>1</b>	<b>10</b>	
<b>XMRA 34</b>	<b>S</b>		<b>-F</b>	<b>-2</b>	<b>A</b>	<b>1</b>	<b>10</b>	

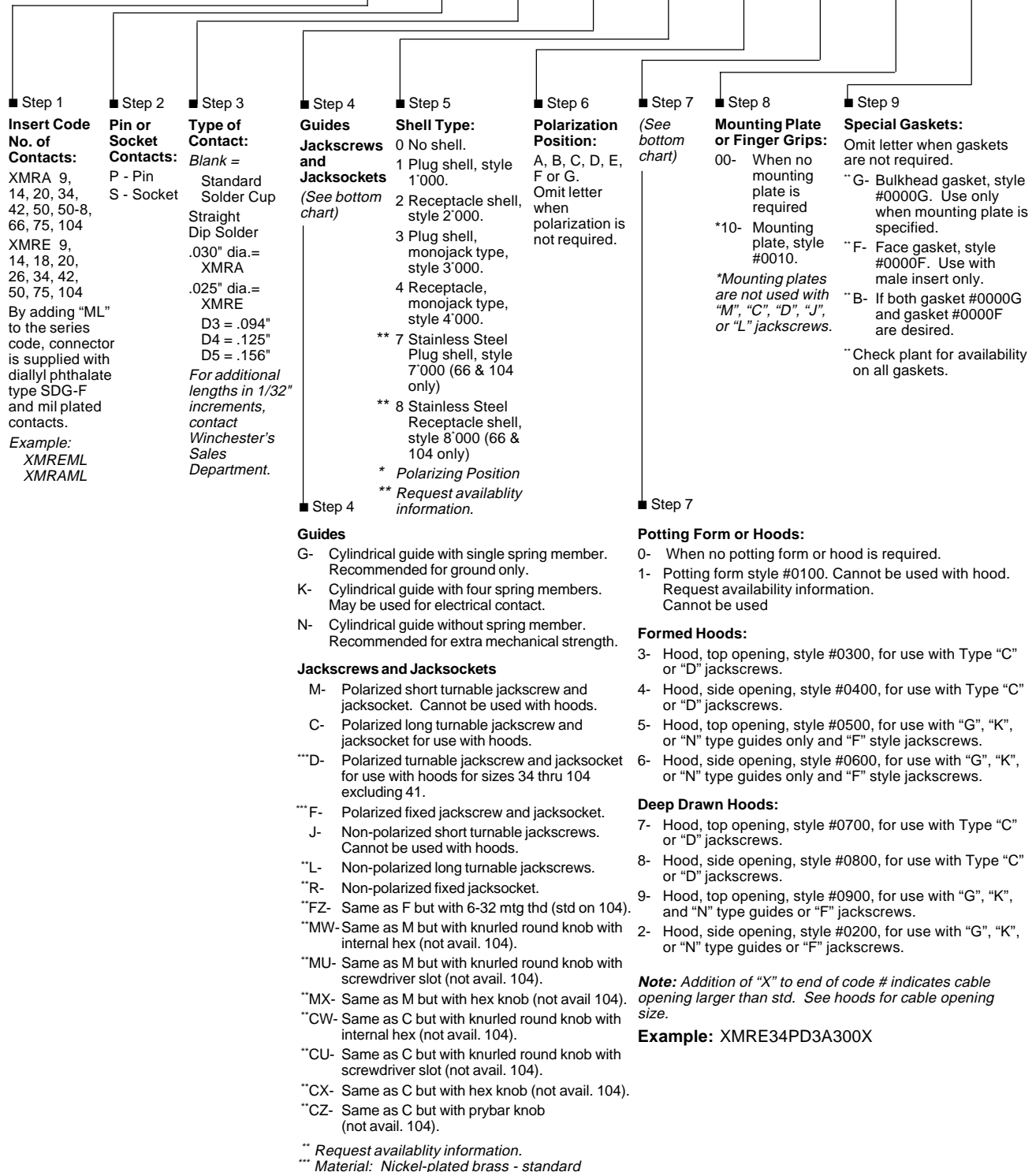

Winchester/Retconn

62 Barnes Industrial Road North, Wallingford, Connecticut 06492 Phone:(203)741-5400 Fax:(203)741-5500 www.winchesterelectronics.com