

## PWM STEP-UP SWITCHING REGULATOR

### FEATURES

- Only 3 external components required ..... Coil, diode, capacitor
- Low operating current ..... Typ. 30 $\mu$ A
- Low ripple and noise
- Low voltage operation ..... 0.9V Max.  
(Output current 1mA)
- Wide Choice of  $V_{OUT}$  ..... 2.7V to 7.5V in 0.1V Steps
- High accuracy output voltage .....  $\pm 2.5\%$  Max.
- High efficiency ..... 85% Typ.
- Soft start circuit ..... 500 $\mu$ s Min.
- Compact packages ..... SOT-89-3 and SOT-89-5
- Larger current can be obtained by connecting an external power transistor

### APPLICATIONS

- Constant voltage source for battery-operated products
- Constant voltage source for cameras, electronic and portable communication products
- Constant voltage source for devices that require a higher voltage than battery voltages

### FUNCTIONAL BLOCK DIAGRAM

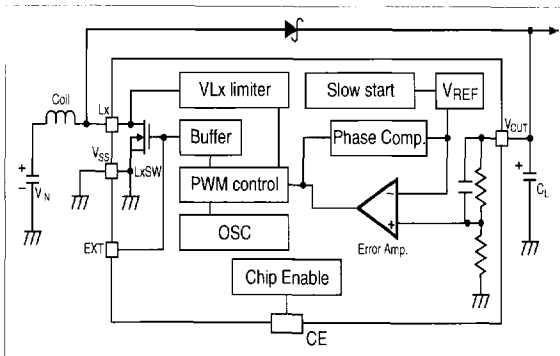

### PIN CONFIGURATION

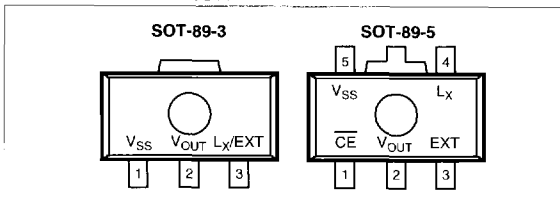

### GENERAL DESCRIPTION

The TC17 Series ICs are PWM control step-up switching regulators. Their unique design keeps external components to a minimum.

The TC171AXX IC consists of an oscillator circuit, PWM control circuit, control transistor (Lx switch), reference voltage source, error amplifier circuit, phase correction circuit, voltage detection resistor, soft start circuit, and Lx switch protection circuit. The internal switch allows output currents of 60 to 80 mA

The TC172BXX ICs are similar to the XX1A series, but have an external transistor drive pin (EXT) instead of an Lx pin. This permits connection of a small external power transistor with a low ON resistance to control much larger currents. The TC172BXX ICs are suitable for applications that require output currents up to several hundred milliamps.

The TC173BXX IC allows either connection and also includes a chip enable circuit so that it is possible to set the standby supply current at 0.5  $\mu$ A max.

A newly developed PWM control circuit allows the TC17 Series ICs to attain the lowest supply current (no load), equal to that of many PFM step-up converters. When  $V_{IN}$  exceeds  $V_{OUT}$  (plus diode and coil drops), the oscillator circuit stops, reducing current drain to 2 $\mu$ A.

The TC17 Series ICs are recommended for applications which require a low ripple PWM DC/DC converter, but cannot adopt conventional circuits because of their large supply currents.

### ORDERING INFORMATION

**PART CODE** TC17 XX XX XX X XX XXX

**Switch Selection:**

- 1A: Internal (see Fig. 1)
- 2B: External (see Fig. 2)
- 3B: Internal & External, plus CE

**Output Voltage:**

Ex: 30 = 3.0V; 50 = 5.0V

**Extra Feature Code:** Fixed: 00

**Temperature:** E: -40°C to +85°C

**Package Type and Pin Count:**

MB: SOT-89-3, MT: SOT-89-5

**Taping Direction:**

723: Left Taping, 713: Right Taping

## TC17 Series

ABSOLUTE MAXIMUM RATINGS:  $V_{SS} = 0.0V$ 

Parameter	Symbol	Limit	Unit
Output Voltage	$V_{OUT}$	12	V
Lx Voltage <sup>1</sup>	$V_{Lx}$	12	V
EXT Pin Voltage <sup>2</sup>	$V_{EXT}$	-0.3 to ( $V_{OUT} + 0.3$ )	V
CE Pin Voltage <sup>3</sup>	$V_{CE}$	-0.3 to ( $V_{OUT} + 0.3$ )	V
Lx Output Current <sup>1</sup>	$I_{Lx}$	250	mA
EXT Pin Current <sup>2</sup>	$I_{EXT}$	±50	mA
Power Dissipation	$P_D$	500	mW
Operating Temperature	$T_{opr}$	-40 to +85	°C
Storage Temperature	$T_{stg}$	-65 to +150	°C

- NOTES: <sup>1</sup> Applicable for 1AXX & 3BXX  
<sup>2</sup> Applicable for 2BXX & 3BXX  
<sup>3</sup> Applicable for 3BXX

## PIN DESCRIPTION

	Pin No			Name	Description
	1AXX	2BXX	3BXX		
1	1	5		$V_{SS}$	Ground
2	2	2		$V_{OUT}$	Voltage Output
3	-	4		Lx	Switching Pin
-	3	3		EXT	Transistor Drive Pin (CMOS)
-	-	1		CE	Chip Enable Pin (Active LOW)

## ELECTRICAL CHARACTERISTICS:

TC171A30:  $V_{OUT} = 3V$ ,  $V_{IN} = 2V$ ,  $V_{SS} = 0V$ ,  $I_{OUT} = 10mA$ ,  $T_A = 25^\circ C$ , unless otherwise specified. (See Fig. 1)

Symbol	Parameter	Test Conditions	Min	Typ	Max	Unit
$V_{IN}$	Input Voltage				8	V
$V_{ST}$	Starting Voltage	$I_{OUT} = 1mA$ , $V_{IN}: 0 \rightarrow 2V$		0.8	0.9	V
$V_{hold}$	Holding Voltage	$I_{OUT} = 1mA$ , $V_{IN}: 2 \rightarrow 0V$	0.7			V
$I_{dd1}$	Supply Current 1	at $V_{OUT}$ pin		15	25	μA
$I_{dd2}$	Supply Current 2	at $V_{OUT}$ pin, $V_{IN} = 3.5V$		2	5	μA
$V_{OUT}$	Output Voltage		2.925	3.000	3.075	V
$I_{Lx}$	Lx Switching Current	$V_{Lx} = 0.4V$	60			mA
$I_{LxL}$	Leakage Current of Lx pin	$V_{Lx} = 6V$ , $V_{IN} = 3.5V$			0.5	μA
$f_{osc}$	Oscillating Frequency		40	50	60	kHz
maxdty	Max. Oscillator Duty Cycle	on ( $V_{Lx}$ "Low")	70	80	90	%
$\eta$	Efficiency		70	85		%
tst	Soft Start Time <sup>1</sup>	Time for $V_{OUT} = 0 \rightarrow 5V$	0.5	2.0		ms
$V_{Lxlim}$	$V_{Lx}$ Pin Voltage Limit <sup>2</sup>	Lx Switch on	0.65	0.8	1.0	V

**ELECTRICAL CHARACTERISTICS (continued):**

**TC171A50:**  $V_{OUT} = 5V$ ,  $V_{IN} = 3V$ ,  $V_{SS} = 0V$ ,  $I_{OUT} = 10mA$ ,  $T_A = 25^\circ C$ , unless otherwise specified. (See Fig. 1)

Symbol	Parameter	Test Conditions	Min	Typ	Max	Unit
$V_{IN}$	Input Voltage				8	V
$V_{ST}$	Starting Voltage	$I_{OUT} = 1mA$ , $V_{IN}: 0 \rightarrow 3V$		0.8	0.9	V
$V_{hold}$	Holding Voltage	$I_{OUT} = 1mA$ , $V_{IN}: 3 \rightarrow 0V$	0.7			V
Idd1	Supply Current 1	at $V_{OUT}$ pin		30	45	$\mu A$
Idd2	Supply Current 2	at $V_{OUT}$ pin, $V_{IN} = 5.5V$		2	5	$\mu A$
$V_{OUT}$	Output Voltage		4.875	5.000	5.125	V
ILx	Lx Switching Current	$VLx = 0.4V$	80			mA
ILxL	Leakage Current of Lx pin	$VLx = 6V$ , $V_{IN} = 5.5V$			0.5	$\mu A$
$f_{osc}$	Oscillating Frequency		40	50	60	kHz
maxdty	Max. Oscillator Duty Cycle	on (VLx "Low")	70	80	90	%
$\eta$	Efficiency		70	85		%
tst	Soft Start Time <sup>1</sup>	Time for $V_{OUT} = 0 \rightarrow 5V$	0.5	2.0		ms
$V_{Lxlim}$	VLx Pin Voltage Limit <sup>2</sup>	Lx Switch on	0.65	0.8	1.0	V

**3**

**TC172B30:**  $V_{OUT} = 3V$ ,  $V_{IN} = 2V$ ,  $V_{SS} = 0V$ ,  $I_{OUT} = 10mA$ ,  $T_A = 25^\circ C$ , unless otherwise specified. (See Fig. 2)

Symbol	Parameter	Test Conditions	Min	Typ	Max	Unit
$V_{IN}$	Input Voltage				8	V
$V_{ST}$	Starting Voltage	EXT no Load, $V_{OUT}: 0 \rightarrow 2V$		0.7	0.8	V
Idd1	Supply Current 1	EXT no Load, $V_{OUT} = 2.9V$		30	50	$\mu A$
Idd2	Supply Current 2	EXT no Load, $V_{OUT} = 3.5V$		2	5	$\mu A$
$V_{OUT}$	Output Voltage		2.925	3.000	3.075	V
$I_{EXTH}$	EXT "H" Output Current	$V_{EXT} = V_{OUT} = -0.4V$	-1.5			mA
$I_{EXTL}$	EXT "L" Output Current	$V_{EXT} = 0.4V$	1.5			mA
$f_{osc}$	Oscillating Frequency		80	100	120	kHz
maxdty	Max. Oscillator Duty Cycle	$V_{EXT}$ "High"	70	80	90	%
tst	Soft Start Time <sup>1</sup>	$V_{OUT} = 0 \rightarrow 3V$	0.5	2.0		ms

**TC172B50:**  $V_{OUT} = 5V$ ,  $V_{IN} = 3V$ ,  $V_{SS} = 0V$ ,  $I_{OUT} = 10mA$ ,  $T_A = 25^\circ C$ , unless otherwise specified. (See Fig. 2)

Symbol	Parameter	Test Conditions	Min	Typ	Max	Unit
$V_{IN}$	Input Voltage				8	V
$V_{ST}$	Starting Voltage	EXT no Load, $V_{OUT}: 0 \rightarrow 3V$		0.7	0.8	V
Idd1	Supply Current 1	EXT no Load, $V_{OUT} = 4.8V$		60	90	$\mu A$
Idd2	Supply Current 2	EXT no Load, $V_{OUT} = 5.5V$		2	5	$\mu A$
$V_{OUT}$	Output Voltage		4.875	5.000	5.125	V
$I_{EXTH}$	EXT "H" Output Current	$V_{EXT} = V_{OUT} = -0.4V$	-2			mA
$I_{EXTL}$	EXT "L" Output Current	$V_{EXT} = 0.4V$	2			mA
$f_{osc}$	Oscillating Frequency		80	100	120	kHz
maxdty	Max. Oscillator Duty Cycle	$V_{EXT}$ "High"	70	80	90	%
tst	Soft Start Time <sup>1</sup>	$V_{OUT} = 0 \rightarrow 5V$	0.5	2.0		ms

## TC17 Series

**ELECTRICAL CHARACTERISTICS (continued):****TC173B30:**  $V_{OUT} = 3.0V$ ,  $V_{IN} = 2V$ ,  $V_{SS} = 0V$ ,  $I_{OUT} = 10mA$ ,  $T_A = 25^{\circ}C$ , unless otherwise specified.

Symbol	Parameter	Test Conditions	Min	Typ	Max	Unit
$V_{OUT}$	Output Voltage		2.925	3.0	3.075	V
$V_{IN}$	Input Voltage				8	V
$V_{ST}$	Starting Voltage	$I_{OUT} = 1mA$ , $V_{IN}: 0 \rightarrow 2V$		0.8	0.9	V
$V_{hold}$	Holding Voltage	$I_{OUT} = 1mA$ , $V_{IN}: 2 \rightarrow 0V$	0.7			V
$\eta$	Efficiency		70	85		%
$I_{dd1}$	Supply Current 1	at $V_{OUT}$ pin		30	50	$\mu A$
$I_{dd2}$	Supply Current 2	at $V_{OUT}$ pin, $V_{IN} = 3.5V$		2	5	$\mu A$
$I_{Lx}$	Lx Switching Current	$V_{Lx} = 0.4V$	60			mA
$I_{LxL}$	Leakage Current of Lx pin	$V_{Lx} = 6V$ , $V_{IN} = 3.5V$			0.5	$\mu A$
$I_{EXTH}$	EXT "H" Output Current	$V_{EXT} = V_{OUT} - 0.4V$	-1.5			mA
$I_{EXTL}$	EXT "L" Output Current	$V_{EXT} = 0.4V$	1.5			mA
$V_{CEH1}$	CE Input Voltage "H"1	$V_{OUT} \geq 1.5V$	$V_{OUT} - 0.4$			V
$V_{CEL1}$	CE Input Voltage "L"1	$V_{OUT} \geq 1.5V$			0.4	V
$V_{CEH2}$	CE Input Voltage "H"2	$0.8V \leq V_{OUT} \leq 1.5V$	$V_{OUT} - 0.1$			V
$V_{CEL2}$	CE Input Voltage "L"2	$0.8V \leq V_{OUT} \leq 1.5V$			0.1	V
$I_{CEH}$	CE Input Current "H"	$CE = 3V$	-0.5		0.5	$\mu A$
$I_{CEL}$	CE Input Current "L"	$CE = 0V$	-0.5		0.5	$\mu A$
$f_{osc}$	Oscillating Frequency		80	100	120	kHz
$maxdty$	Max. Oscillator Duty Cycle	on ( $V_{Lx}$ "Low")	70	80	90	%
$t_{start}$	Soft Start Time <sup>1</sup>	$V_{OUT} = 0 \rightarrow 3V$	0.5	2.0		ms
$V_{Lxlim}$	Lx Pin Voltage Limit <sup>2</sup>	Lx Switch on	0.65	0.8	1.0	V

**ELECTRICAL CHARACTERISTICS (continued):**

**TC173B50:**  $V_{OUT} = 5.0V$ ,  $V_{IN} = 3V$ ,  $V_{SS} = 0V$ ,  $I_{OUT} = 10mA$ ,  $T_A = 25^{\circ}C$ , unless otherwise specified.

Symbol	Parameter	Test Conditions	Min	Typ	Max	Unit
$V_{OUT}$	Output Voltage		4.875	5.0	5.125	V
$V_{IN}$	Input Voltage				8	V
$V_{ST}$	Starting Voltage	$I_{OUT} = 1mA$ , $V_{IN}: 0 \rightarrow 3V$		0.8	0.9	V
$V_{hold}$	Holding Voltage	$I_{OUT} = 1mA$ , $V_{IN}: 3 \rightarrow 0V$	0.7			V
$\eta$	Efficiency		70	85		%
$I_{dd1}$	Supply Current 1	at $V_{OUT}$ pin		60	90	$\mu A$
$I_{dd2}$	Supply Current 2	at $V_{OUT}$ pin, $V_{IN} = 5.5V$		2	5	$\mu A$
$I_{Lx}$	Lx Switching Current	$VLx = 0.4V$	80			mA
$I_{LxL}$	Leakage Current of Lx pin	$VLx = 6V$ , $V_{IN} = 5.5V$			0.5	$\mu A$
$I_{EXTH}$	EXT "H" Output Current	$V_{EXT} = V_{OUT} - 0.4V$	-2.0			mA
$I_{EXTL}$	EXT "L" Output Current	$V_{EXT} = 0.4V$	2.0			mA
$V_{CEH1}$	CE Input Voltage "H"1	$V_{OUT} \geq 1.5V$	$V_{OUT} - 0.4$			V
$V_{CEL1}$	CE Input Voltage "L"1	$V_{OUT} \geq 1.5V$			0.4	V
$V_{CEH2}$	CE Input Voltage "H"2	$0.8V \leq V_{OUT} \leq 1.5V$	$V_{OUT} - 0.1$			V
$V_{CEL2}$	CE Input Voltage "L"2	$0.8V \leq V_{OUT} \leq 1.5V$			0.1	V
$I_{CEH}$	CE Input Current "H"	CE = 5V	-0.5		0.5	$\mu A$
$I_{CEL}$	CE Input Current "L"	CE = 0V	-0.5		0.5	$\mu A$
$f_{osc}$	Oscillating Frequency		80	100	120	kHz
maxdty	Max. Oscillator Duty Cycle	on (VLx "Low")	70	80	90	%
$t_{start}$	Soft Start Time <sup>1</sup>	$V_{OUT} = 0 \rightarrow 5V$	0.5	2.0		ms
$V_{Lxlim}$	VLx Pin Voltage Limit <sup>2</sup>	Lx Switch on	0.65	0.8	1.0	V

**3**

Note 1: The soft start circuit follows the sequence below:

When  $V_{IN}$  is applied  $\rightarrow V_{REF}$  is kept at 0V for about 200 $\mu s$   $\rightarrow$  During this period, error amplifier output is brought to "H"  $\rightarrow V_{REF}$  rises and then the error amplifier output gradually decreases to the appropriate value due to the internal phase compensation circuit. Accordingly, the output gradually increases.

Note 2:  $I_{Lx}$  gradually rises after the Lx switch is turned on, and  $VLx$  rises accordingly. If the voltage reaches  $V_{Lxlim}$ , the Lx switch protection circuit turns off the Lx switch.

**NOTICE**

To use these ICs, note the following points:

- Place external components as close as possible to the IC to reduce wiring. In particular, wire the capacitor connected to the  $V_{OUT}$  pin using the shortest route possible.
- Ensure sufficient grounding. The  $V_{SS}$  pin receives large currents due to switching. High impedance in the  $V_{SS}$  routing causes the internal potential of the IC to fluctuate with the switching current, resulting in unstable operation.
- Use capacitors with good high frequency response, such as tantalum capacitors or electrolytic aluminum + ceramic capacitors. The capacity must be 10 $\mu F$  or more. It is recommended that the rated voltage of the capacitors be at least three times the specified output voltage, because the coil may cause a high spike-like voltage when the Lx transistor is turned off.
- Select coils that have a small DC resistance and are not magnetically-saturated easily. If the coil inductance is too small,  $I_{Lx}$  may exceed the absolute maximum rating under maximum load. Select the proper inductance value.
- Use Schottky diodes with fast switching speed, and adequate current-carrying capability.

**TC17 Series**

**MARKING**

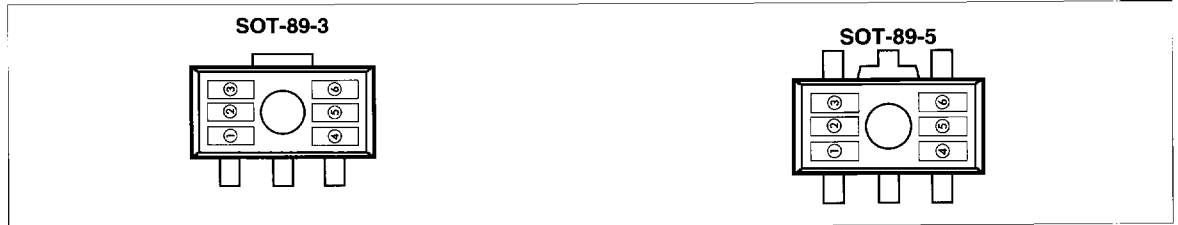

a and b represents first digit and decimal place of  $V_{OUT}$ .  
For example:

Mark a	Mark b	$V_{OUT}$ Voltage
2	7	2.7V

c represents driver type

Mark c	Type	
1	1	TC171AXX Internal Switch (SOT-89-3-only)
2	2	TC172BXX External Switch (SOT-89-3-only)
3	3	TC173BXX Int./Ext. Switch, plus CE (SOT-89-5-only)

d and e represent assembly lot number

f represents oscillator frequency

Mark f	Type	
A	A	50kHz
B	B	100kHz

**TEST CIRCUITS**

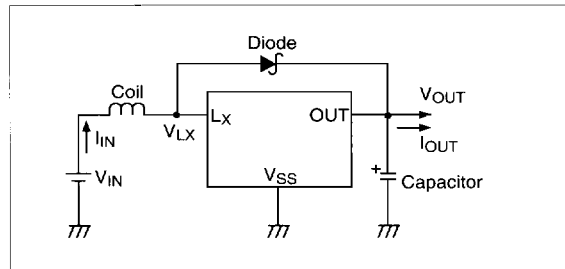

Figure 1. TC171AXX

**Parts**

Capacitor	22 $\mu$ F (Tantalum)
Coil	120 $\mu$ H, 270 $\mu$ H (Sumida Electric Company Ltd., CM-5)
Diode	MA721 (Matsushita Electronics Corp., Schottky)

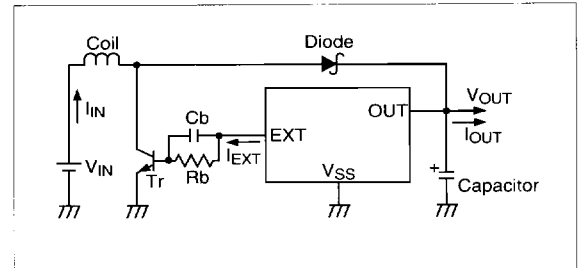

Figure 2. TC172BXX

**Parts**

Capacitor	100 $\mu$ F (Aluminum Electrolytic)// 22 $\mu$ F (Tantalum)
Coil	28 $\mu$ H (Sumida Electric Company Ltd., CM-5)
Diode	MA721 (Matsushita Electronics Corp., Schottky)
Transistor	2SD1628G
Rb	300 $\Omega$
Cb	0.01 $\mu$ F

**TYPICAL CHARACTERISTICS**

**1) Output Voltage vs. Output Current ( $T_A = 25^\circ\text{C}$ )**

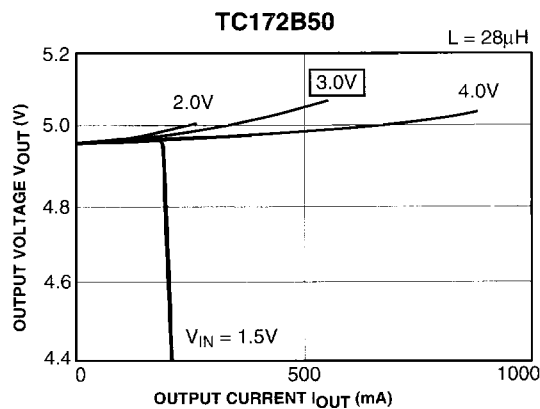
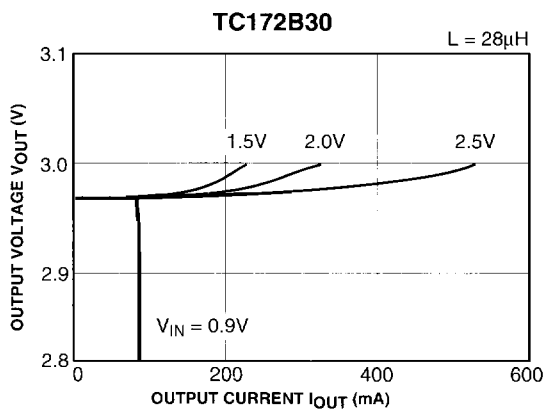
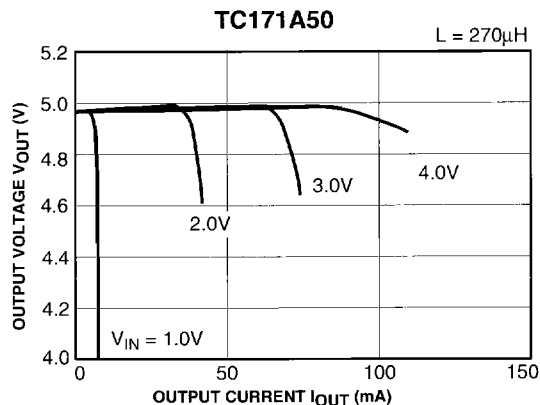
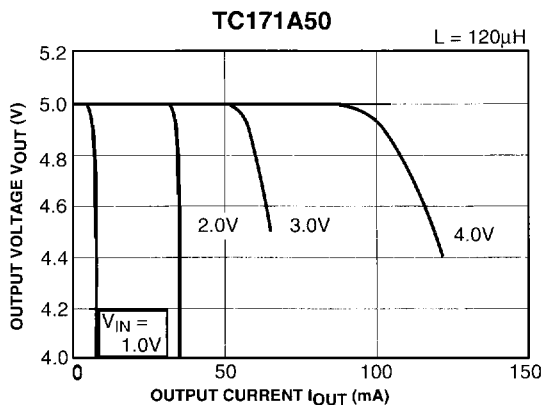
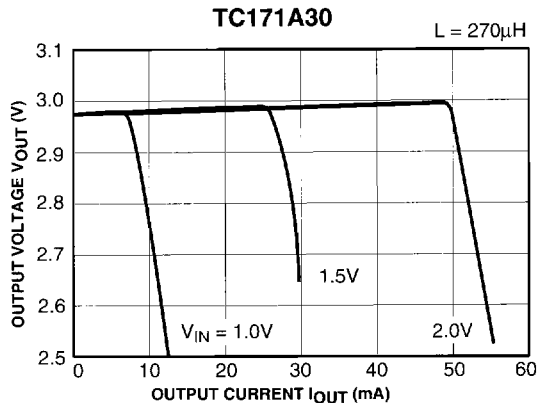
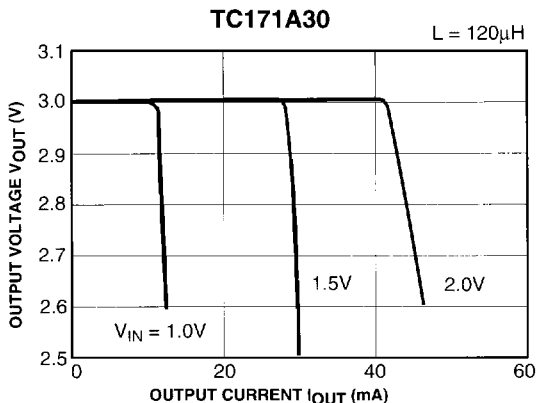

**3**

**TC17 Series**

**TYPICAL CHARACTERISTICS**

**2) Efficiency vs. Output Current ( $T_A = 25^\circ\text{C}$ )**

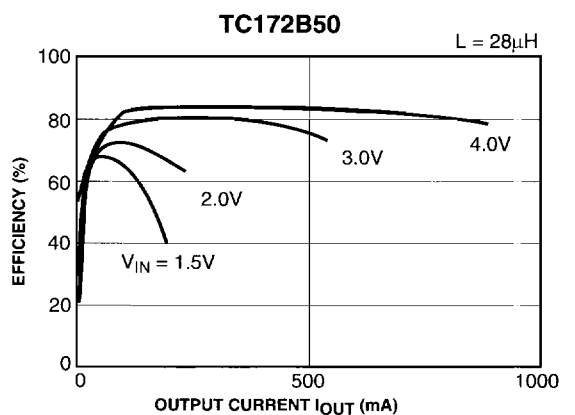
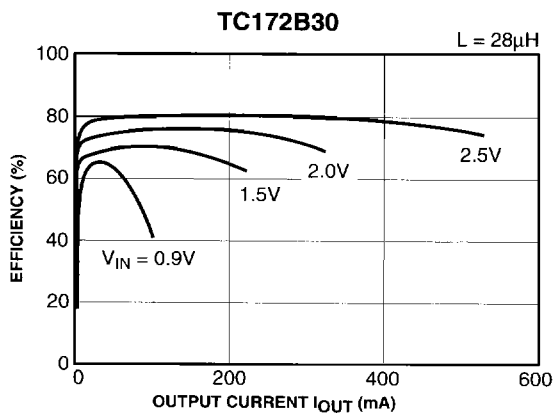
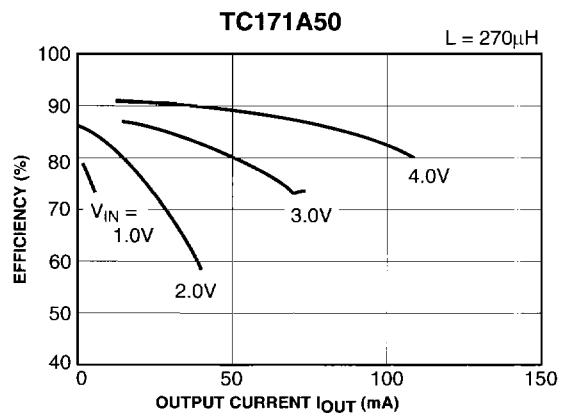
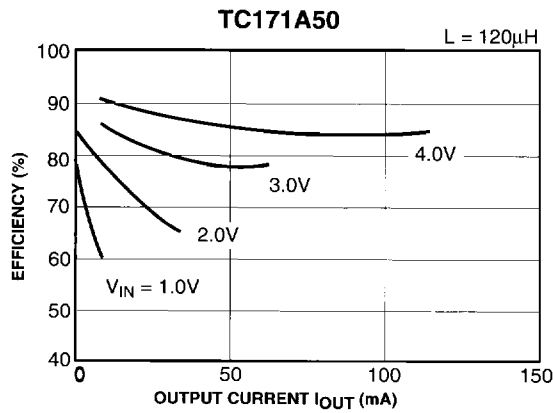
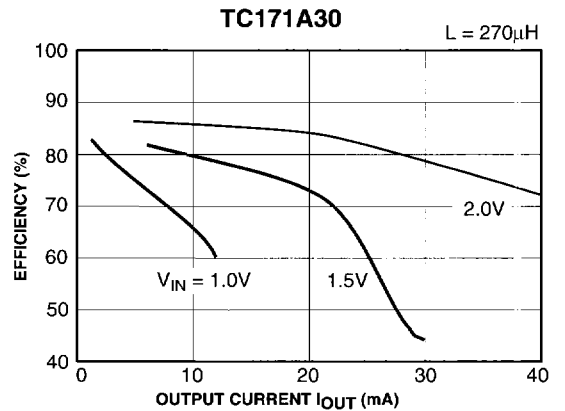
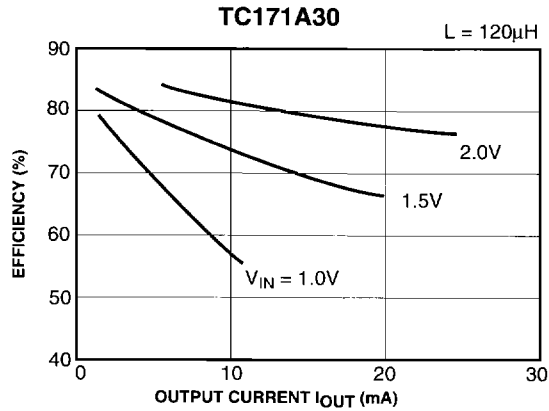



**TYPICAL CHARACTERISTICS**

**3) Supply Current (No Load) vs. Input Voltage ( $T_A = 25^\circ\text{C}$ )**

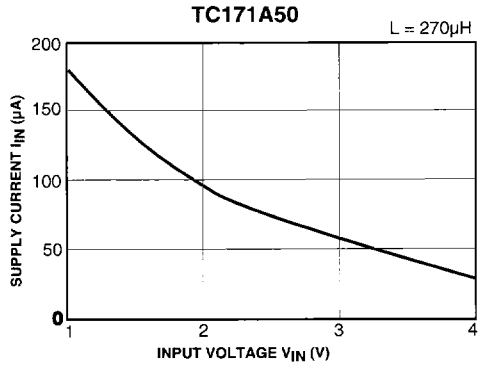
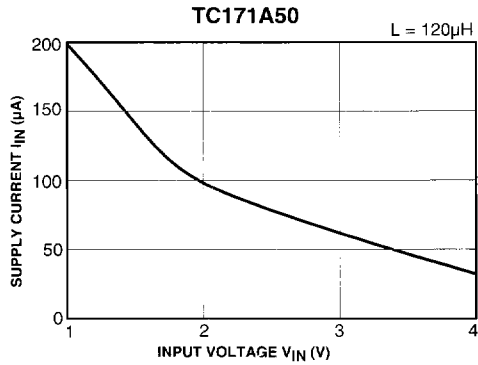
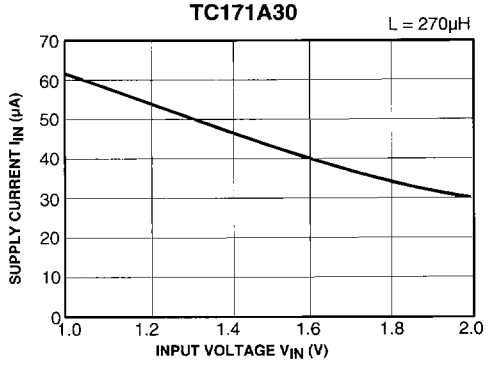
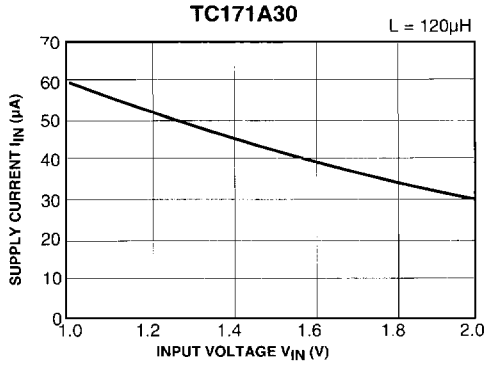

**3**

TC17 Series

TYPICAL CHARACTERISTICS

4) Output Ripple Voltage vs. Output Current ( $T_A = 25^\circ\text{C}$ )

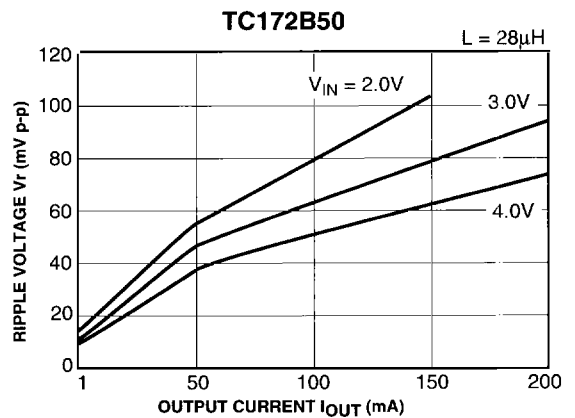
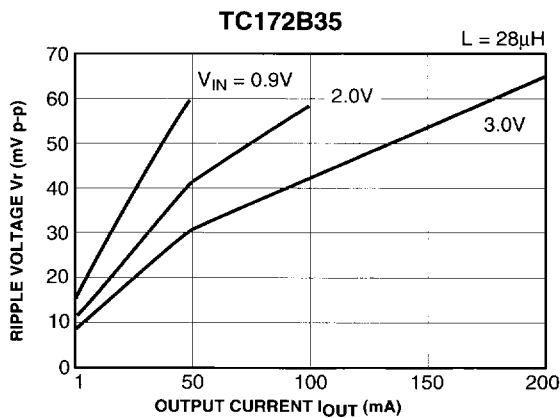
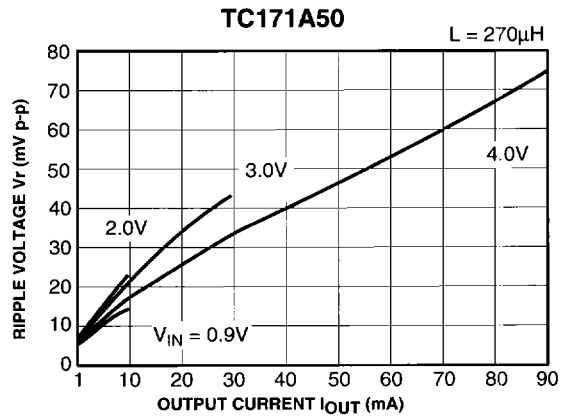
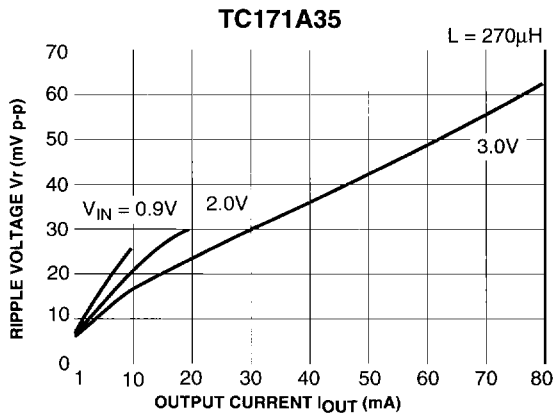
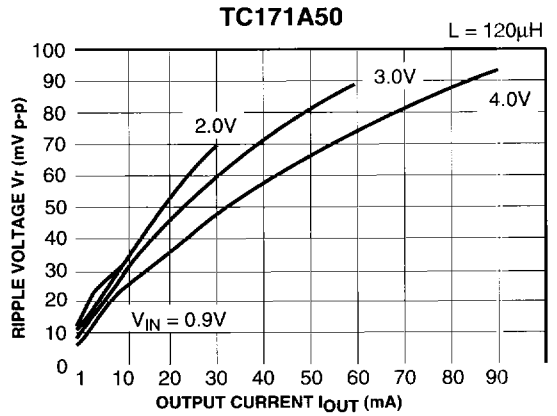
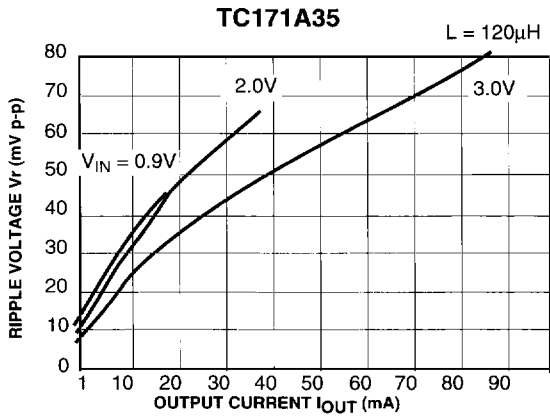

**TYPICAL CHARACTERISTICS**

**5) Start-up/Hold-on Voltage vs. Output Current ( $T_A = 25^\circ\text{C}$ )**

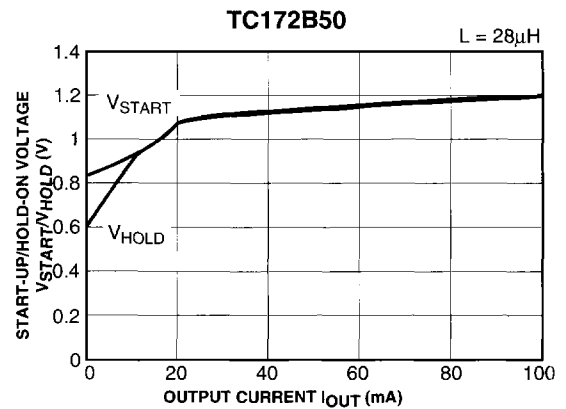
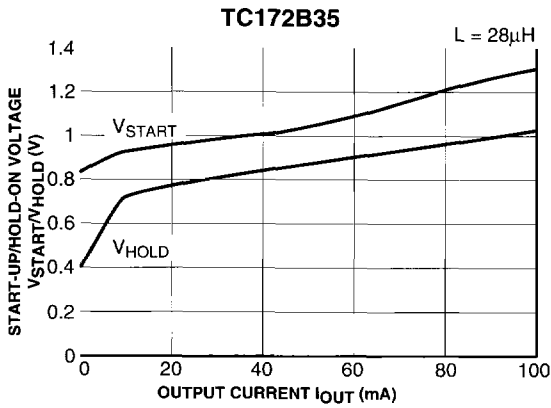
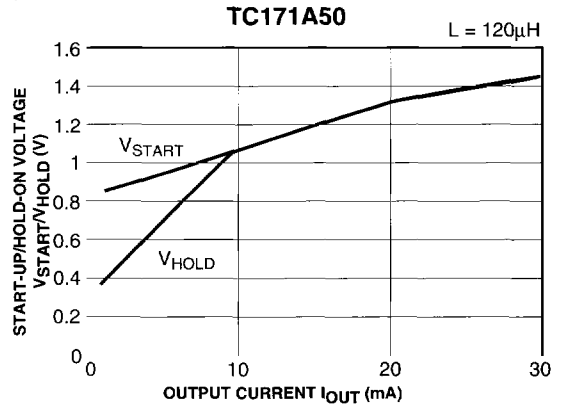
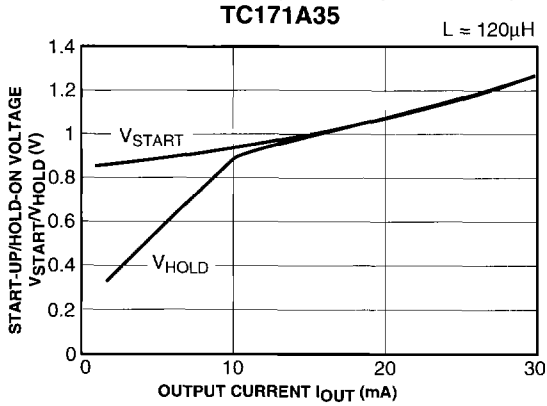

**3**



**TYPICAL CHARACTERISTICS**

**7) Output Voltage vs. Temperature ( $T_A = 25^\circ\text{C}$ )**

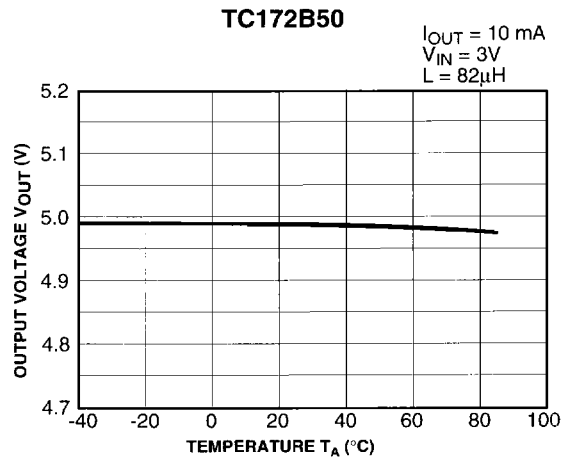
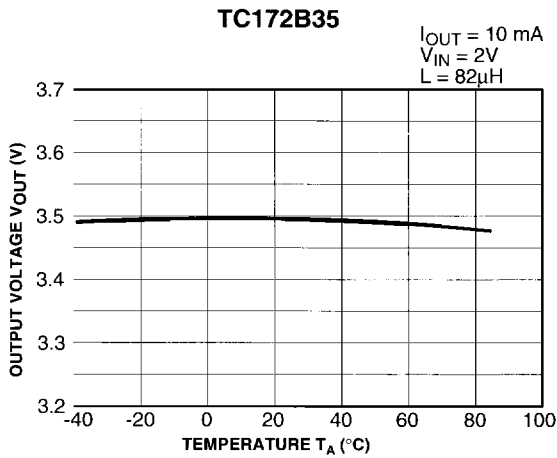
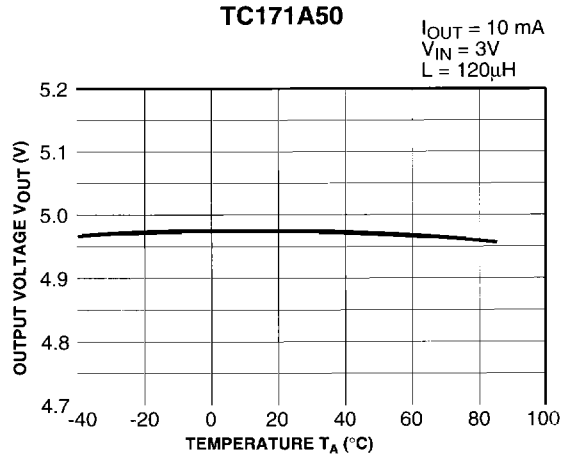
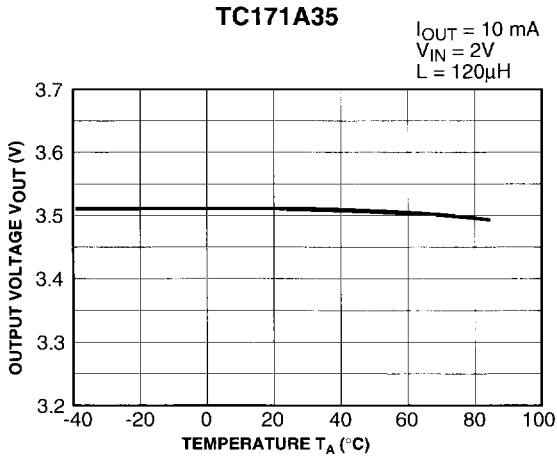

**3**

**TC17 Series**

**TYPICAL CHARACTERISTICS**

**8) Oscillator Frequency vs. Temperature ( $T_A = 25^\circ\text{C}$ )**

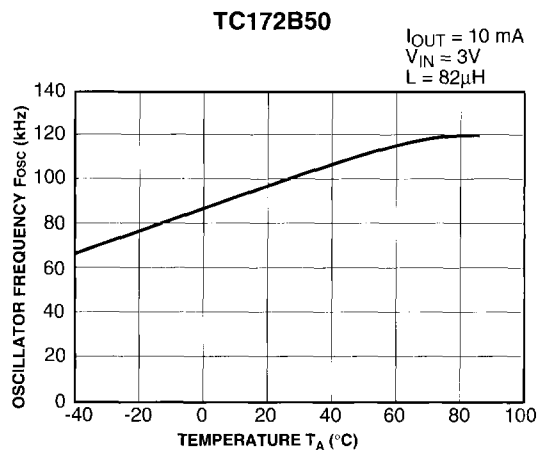
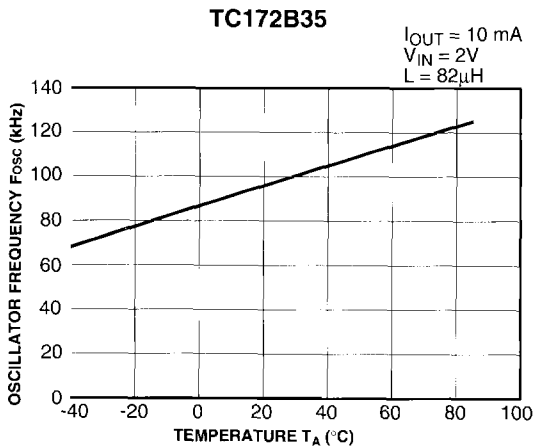
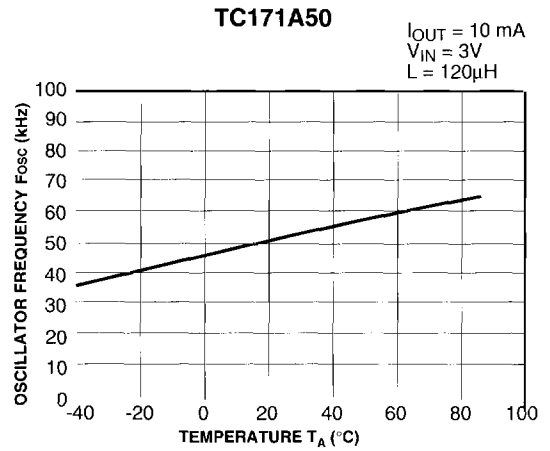
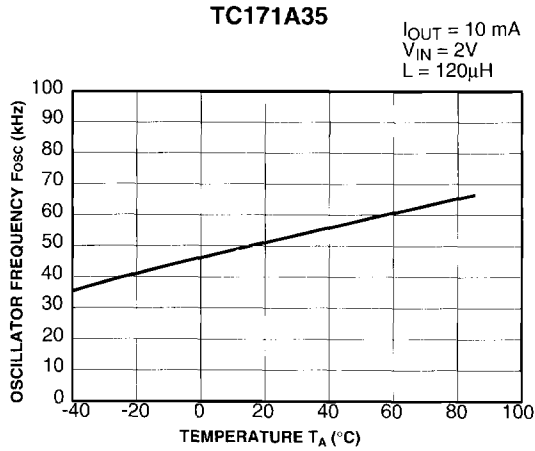

**TYPICAL CHARACTERISTICS**

**9) Oscillator Max Duty Cycle vs. Temperature ( $T_A = 25^\circ\text{C}$ )**

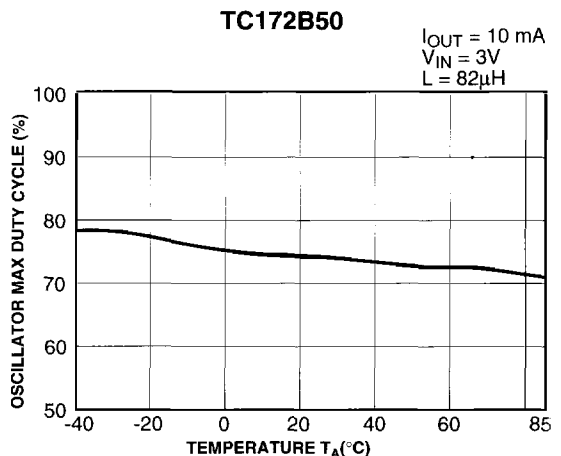
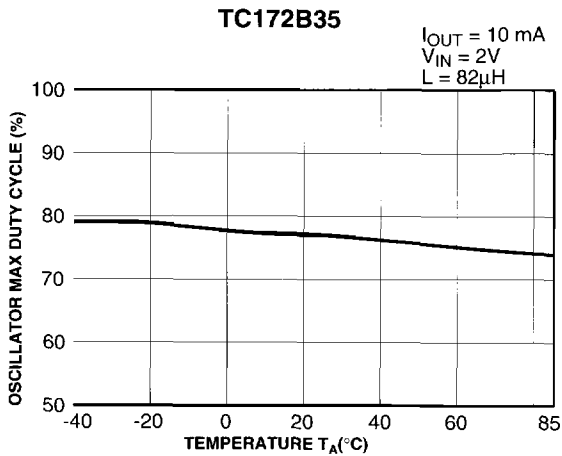
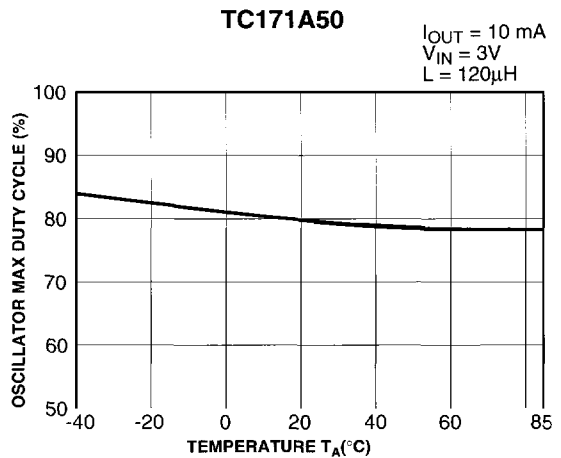
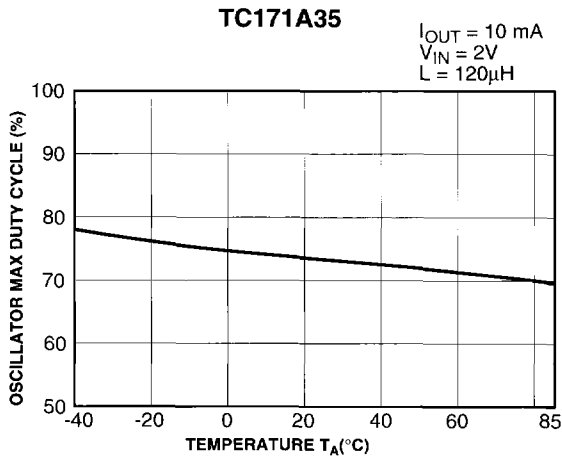

**3**





### TYPICAL CHARACTERISTICS

#### 11) Ripple Voltage vs. Output Current ( $T_A = 25^\circ\text{C}$ )

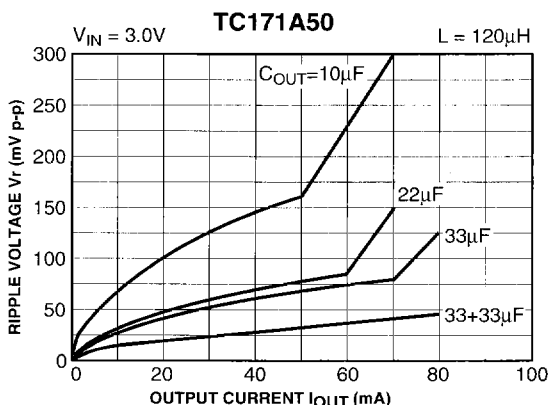
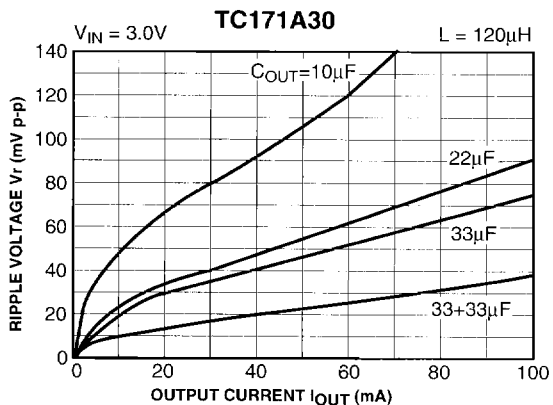
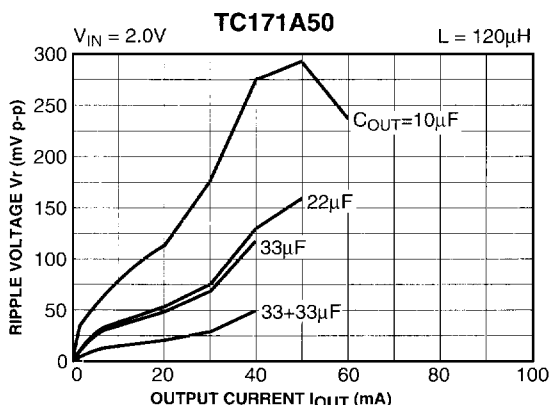
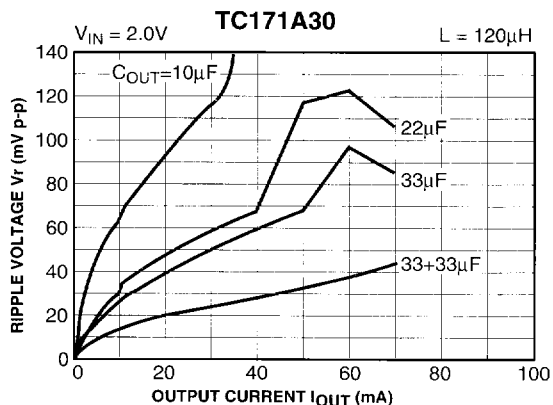
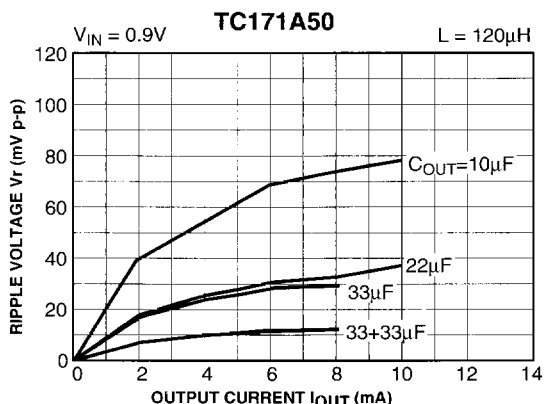
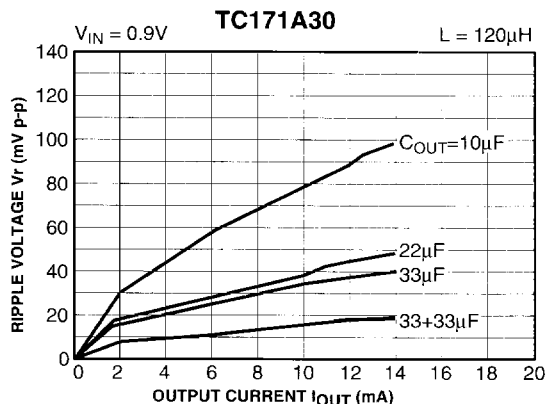

3

TC17 Series

TYPICAL CHARACTERISTICS

12) Output Voltage vs. Output Current

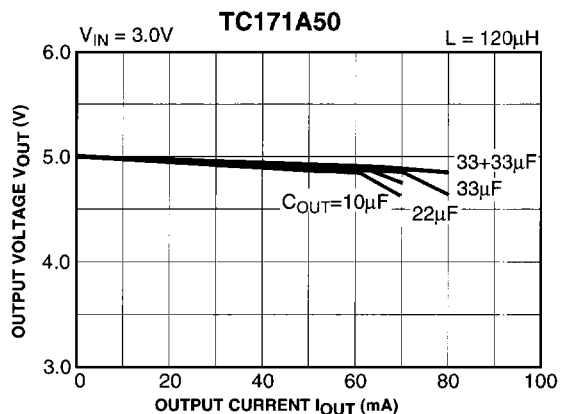
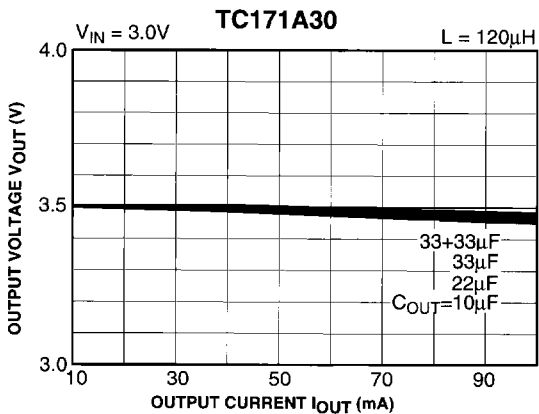
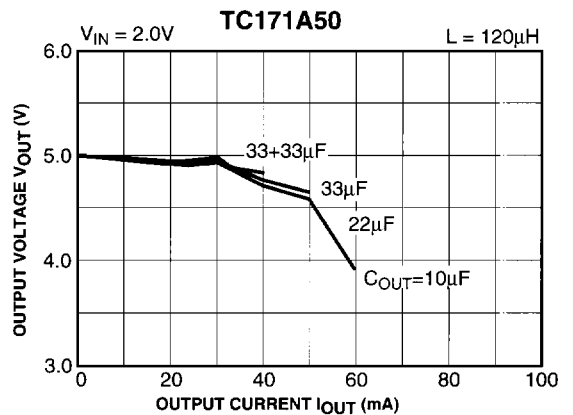
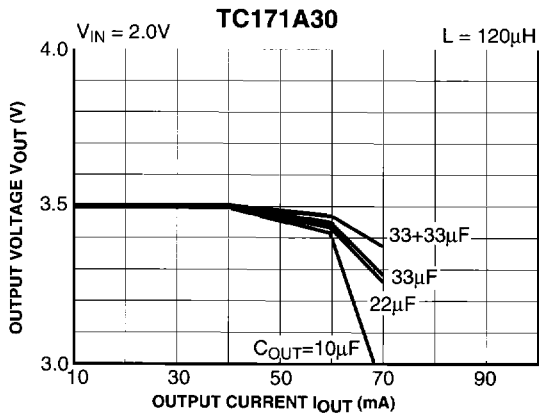
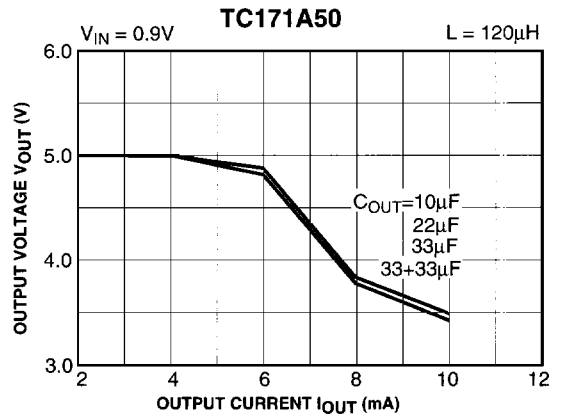
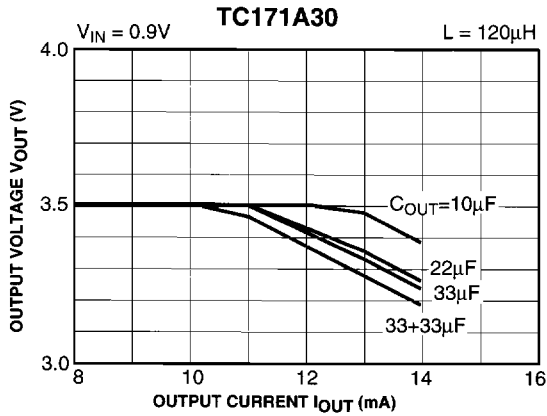

**TYPICAL CHARACTERISTICS**

**13) Ripple Voltage vs. Output Current**

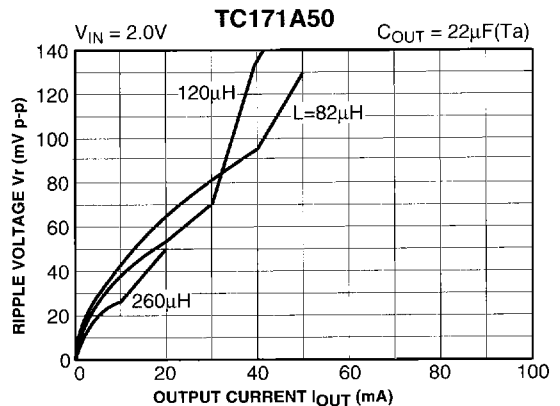
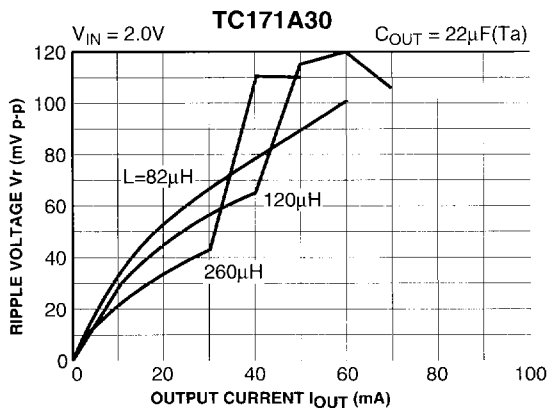
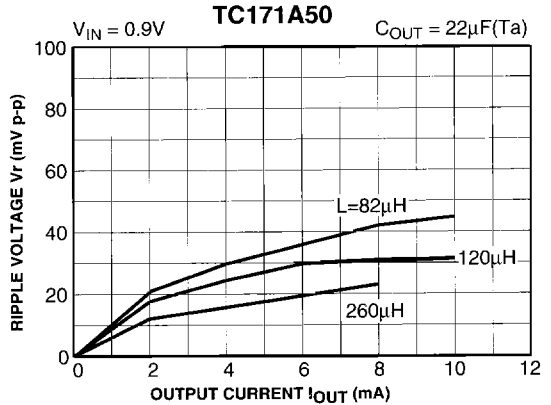
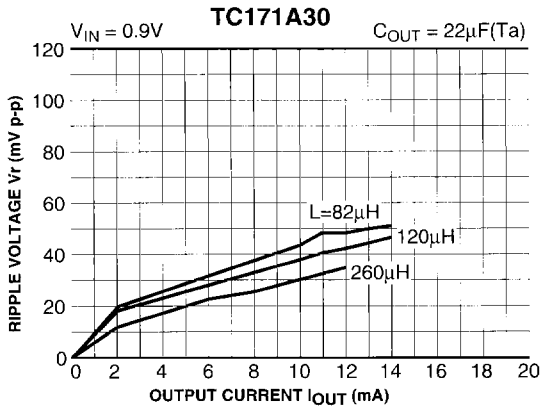
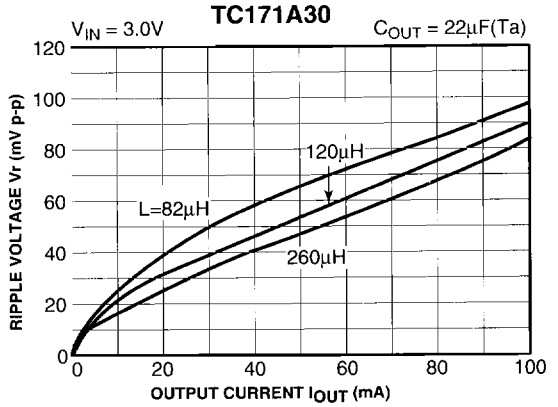
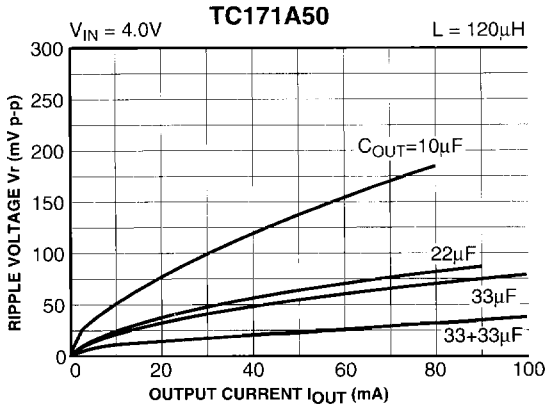

**3**

**TC17 Series**

**TYPICAL CHARACTERISTICS**

**14) Output Voltage vs. Output Current**

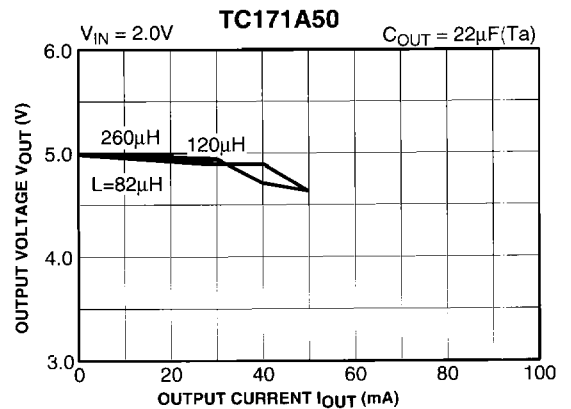
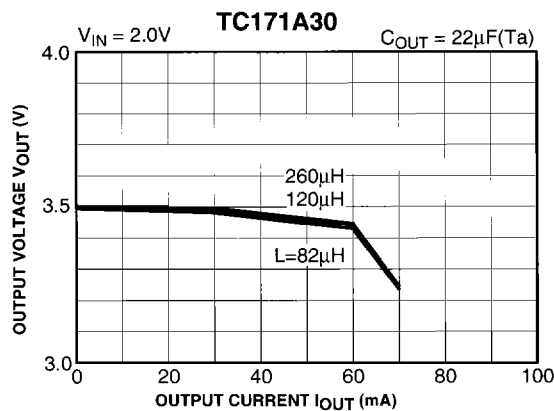
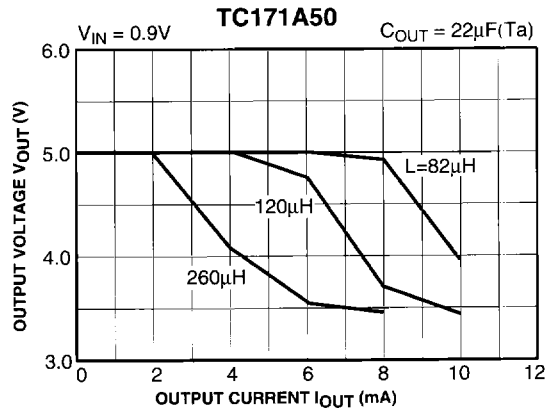
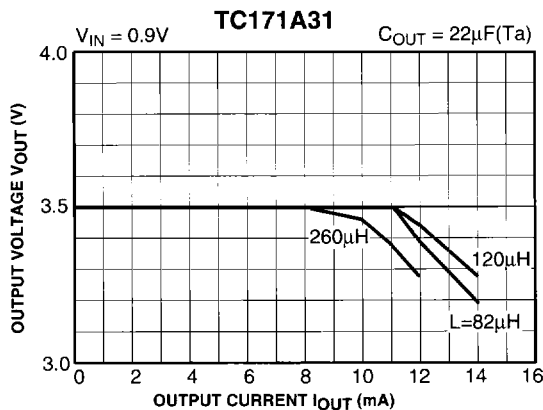
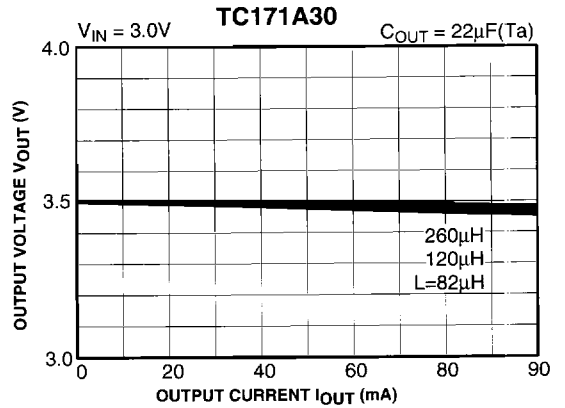
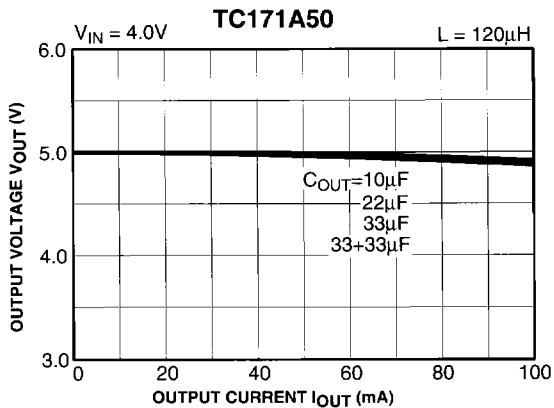

**TYPICAL CHARACTERISTICS**

**15) Ripple Voltage vs. Output Current ( $T_A = 25^\circ\text{C}$ )**

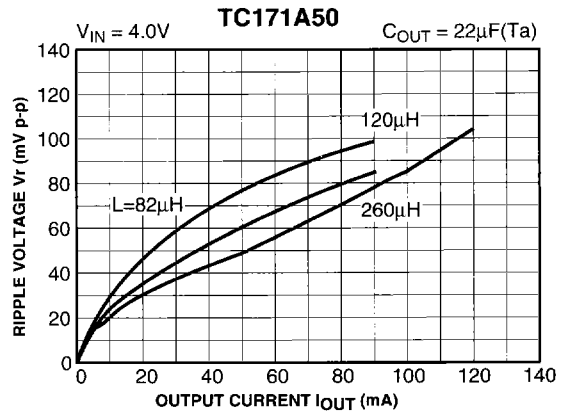
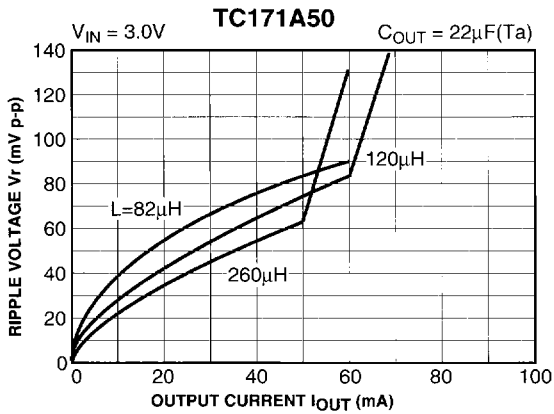

**16) Output Voltage vs. Output Current**

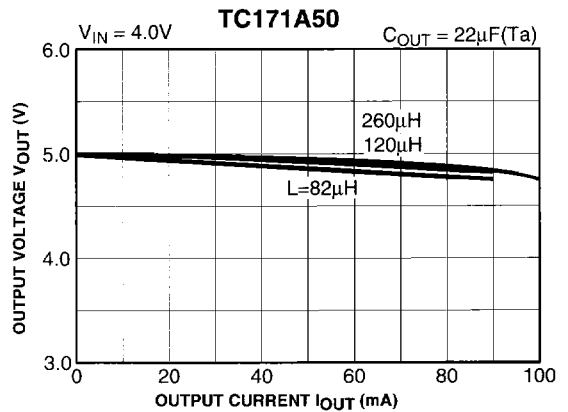
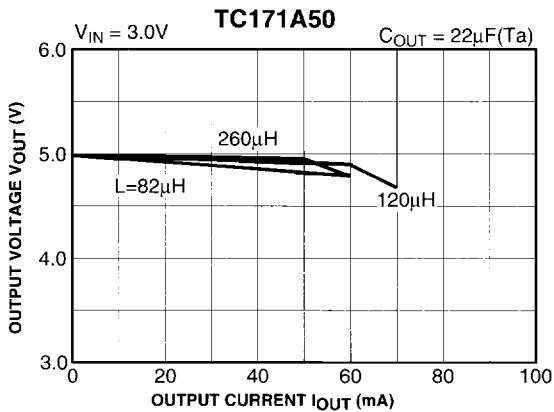

**3**