

## 240pin DDR2 SDRAM Unbuffered DIMMs based on 512 Mb B ver.

This Hynix unbuffered Dual In-Line Memory Module(DIMM) series consists of 512Mb B ver. DDR2 SDRAMs in Fine Ball Grid Array(FBGA) packages on a 240pin glass-epoxy substrate. This Hynix 512Mb B ver. based DDR2 Unbuffered DIMM series provide a high performance 8 byte interface in 133.35mm width form factor of industry standard. It is suitable for easy interchange and addition.

### FEATURES

- JEDEC standard Double Data Rate2 Synchronous DRAMs (DDR2 SDRAMs) with 1.8V +/- 0.1V Power Supply
- All inputs and outputs are compatible with SSTL\_1.8 interface
- 4 Bank architecture
- Posted CAS
- Programmable CAS Latency 3 , 4 , 5, 6
- OCD (Off-Chip Driver Impedance Adjustment)
- ODT (On-Die Termination)
- Fully differential clock operations (CK &  $\overline{CK}$ )
- Programmable Burst Length 4 / 8 with both sequential and interleave mode
- Auto refresh and self refresh supported
- Partial Array Self Refresh supported
- 8192 refresh cycles / 64ms
- Serial presence detect with EEPROM
- DDR2 SDRAM Package: 60ball FBGA(64Mx8), 84ball FBGA(32Mx16)
- 133.35 x 30.00 mm form factor
- Lead-free Products are RoHS compliant

### ORDERING INFORMATION

| Part Name                    | Density | Organization | # of DRAMs | # of ranks | Materials | ECC  |
|------------------------------|---------|--------------|------------|------------|-----------|------|
| HYMP532U64BP6-E3/C4/Y5       | 256MB   | 32Mx64       | 4          | 1          | Lead free | None |
| HYMP564U64BP8-E3/C4/Y5/S5/S6 | 512MB   | 64Mx64       | 8          | 1          | Lead free | None |
| HYMP564U72BP8-E3/C4/Y5/S5    | 512MB   | 64Mx72       | 9          | 1          | Lead free | ECC  |
| HYMP512U64BP8-E3/C4/Y5/S5/S6 | 1GB     | 128Mx64      | 16         | 2          | Lead free | None |
| HYMP512U72BP8-E3/C4/Y5/S5    | 1GB     | 128Mx72      | 18         | 2          | Lead free | ECC  |

This document is a general product description and is subject to change without notice. Hynix Semiconductor does not assume any responsibility for use of circuits described. No patent licenses are implied.

**SPEED GRADE & KEY PARAMETERS**

|             | <b>E3<br/>(DDR2-400)</b> | <b>C4<br/>(DDR2-533)</b> | <b>Y5<br/>(DDR2-667)</b> | <b>S5<br/>(DDR2-800)</b> | <b>S6<br/>(DDR2-800)</b> | <b>Unit</b> |
|-------------|--------------------------|--------------------------|--------------------------|--------------------------|--------------------------|-------------|
| Speed @CL3  | 400                      | 400                      | 400                      | 400                      | -                        | Mbps        |
| Speed @CL4  | 400                      | 533                      | 533                      | 533                      | 533                      | Mbps        |
| Speed @CL5  | 400                      | 533                      | 667                      | 800                      | 667                      | Mbps        |
| Speed @CL6  | -                        | -                        | -                        | -                        | 800                      | Mbps        |
| CL-tRCD-tRP | 3-3-3                    | 4-4-4                    | 5-5-5                    | 5-5-5                    | 6-6-6                    | tCK         |

**ADDRESS TABLE**

| <b>Density</b> | <b>Organization</b> | <b>Ranks</b> | <b>SDRAMs</b> | <b># of DRAMs</b> | <b># of row/bank/column Address</b> | <b>Refresh Method</b> |
|----------------|---------------------|--------------|---------------|-------------------|-------------------------------------|-----------------------|
| <b>256MB</b>   | 32M x 64            | 1            | 32Mb x 16     | 4                 | 13(A0~A12)/2(BA0~BA1)/10(A0~A9)     | 8K / 64ms             |
| <b>512MB</b>   | 64M x 64            | 1            | 64Mb x 8      | 8                 | 13(A0~A12)/2(BA0~BA1)/10(A0~A9)     | 8K / 64ms             |
| <b>512MB</b>   | 64M x 72            | 1            | 64Mb x 8      | 9                 | 13(A0~A12)/2(BA0~BA1)/10(A0~A9)     | 8K / 64ms             |
| <b>1GB</b>     | 128M x 64           | 2            | 64Mb x 8      | 16                | 14(A0~A13)/2(BA0~BA1)/10(A0~A9)     | 8K / 64ms             |
| <b>1GB</b>     | 128M x 72           | 2            | 64Mb x 8      | 18                | 14(A0~A13)/2(BA0~BA1)/10(A0~A9)     | 8K / 64ms             |

**Input/Output Functional Description**

| Symbol                                  | Type   | Polarity              | Pin Description  |
|---|--------|-----------------------|--|
| CK[2:0], $\overline{\text{CK}}$ [2:0]   | SSTL   | Differential Crossing | CK and $\overline{\text{CK}}$ are differential clock inputs. All the DDR2 SDRAM addr/cntl inputs are sampled on the crossing of positive edge of CK and negative edge of $\overline{\text{CK}}$ . Output(read) data is reference to the crossing of CK and $\overline{\text{CK}}$ (Both directions of crossing)  |
| CKE[1:0]                                | SSTL   | Active High           | Activates the DDR2 SDRAM CK signal when high and deactivates the CK signal when low. By deactivating the clocks, CKE low initiates the Power Down mode or the Self Refresh mode.   |
| $\overline{\text{S}}$ [1:0]             | SSTL   | Active Low            | Enables the associated DDR2 SDRAM command decoder when low and disables the command decoder when high. When the command decoder is disabled, new commands are ignored but previous operations continue. Rank 0 is selected by $\overline{\text{S}}_0$ ; Rank 1 is selected by $\overline{\text{S}}_1$  |
| RAS, CAS, WE                            | SSTL   | Active Low            | $\overline{\text{RAS}}$ , $\overline{\text{CAS}}$ and $\overline{\text{WE}}$ (ALONG WITH S) define the command being entered.  |
| ODT[1:0]                                | SSTL   | Active High           | Asserts on-die termination for DQ, DM, DQS and $\overline{\text{DQS}}$ signals if enabled via the DDR2 SDRAM mode register.  |
| Vref                                    | Supply |                       | Reference voltage for SSTL18 inputs  |
| V <sub>DDQ</sub>                        | Supply |                       | Power supplies for the DDR2 SDRAM output buffers to provide improved noise immunity. For all current DDR2 unbuffered DIMM designs, V <sub>DDQ</sub> shares the same power plane as V <sub>DD</sub> pins.   |
| BA[2:0]                                 | SSTL   | -                     | Selects which DDR2 SDRAM internal bank of four or eight is activated.  |
| A[9:0], A10/AP, A[13:11]                | SSTL   | -                     | During a Bank Activate command cycle, Address input defines the row address(RA0~RA15)<br><br>During a Read or Write command cycle, Address input defines the column address when sampled at the cross point of the rising edge of CK and falling edge of CK. In addition to the column address, AP is used to invoke autoprecharge operation at the end of the burst read or write cycle. If AP is high., autoprecharge is selected and BA0-BAN defines the bank to be precharged. If AP is low, autoprecharge is disabled. During a Precharge command cycle., AP is used in conjunction with BA0-BAN to control which bank(s) to precharge. If AP is high, all banks will be precharged regardless of the state of BA0-BAN inputs. If AP is low, then BA0-BAN are used to define which bank to precharge. |
| DQ[63:0], CB[7:0]                       | SSTL   | -                     | Data and Check Bit Input/Output pins.  |
| DM[8:0]                                 | SSTL   | Active High           | DM is an input mask signal for write data. Input data is masked when DM is sampled High coincident with that input data during a write access. DM is sampled on both edges of DQS. Although DM pins are input only, the DM loading matches the DQ and DQS loading.   |
| V <sub>DD</sub> , V <sub>SS</sub>       | Supply |                       | Power and ground for the DDR2 SDRAM input buffers, and core logic. V <sub>DD</sub> and V <sub>DDQ</sub> pins are tied to V <sub>DD</sub> /V <sub>DDQ</sub> planes on these modules.  |
| DQS[8:0], $\overline{\text{DQS}}$ [8:0] | SSTL   | Differential crossing | Data strobe for input and output data. For Rawcards using x16 organized DRAMs, DQ0~7 connect to the LDQS pin of the DRAMs and DQ8~15 connect to the UDQS pin of the DRAM   |
| SA[2:0]                                 |        | -                     | These signals are tied at the system planar to either V <sub>SS</sub> or V <sub>DD</sub> to configure the serial SPD EEPROM.   |
| SDA                                     |        | -                     | This is a bidirectional pin used to transfer data into or out of the SPD EEPROM. A resistor must be connected to V <sub>DD</sub> to act as a pull up.  |
| SCL                                     |        | -                     | This signal is used to clock data into and out of the SPD EEPROM. A resistor may be connected from SCL to V <sub>DD</sub> to act as a pull up on the system board.   |
| VDDSPD                                  | Supply |                       | Power supply for SPD EEPROM. This supply is separate from the VDD/VDDQ power plane. EEPROM supply is operable from 1.7V to 3.6V.   |

## PIN CONFIGURATION

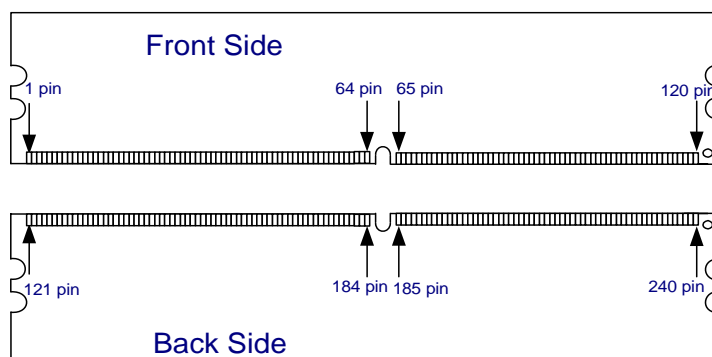

## PIN ASSIGNMENT

| Pin | Name                     | Pin | Name  | Pin | Name                     | Pin | Name                    | Pin | Name     | Pin | Name                    |
|-----|--------------------------|-----|---|-----|--------------------------|-----|-------------------------|-----|----------|-----|-------------------------|
| 1   | VREF                     | 41  | VSS   | 81  | DQ33                     | 121 | VSS                     | 161 | NC(CB4)* | 201 | VSS                     |
| 2   | VSS                      | 42  | NC(CB0)*  | 82  | VSS                      | 122 | DQ4                     | 162 | NC(CB5)* | 202 | DM4                     |
| 3   | DQ0                      | 43  | NC(CB1)*  | 83  | $\overline{\text{DQS}}4$ | 123 | DQ5                     | 163 | VSS      | 203 | NC                      |
| 4   | DQ1                      | 44  | VSS   | 84  | DQS4                     | 124 | VSS                     | 164 | NC(DM8)* | 204 | VSS                     |
| 5   | VSS                      | 45  | $\overline{\text{NC}}(\overline{\text{DQS}}8)*$ | 85  | VSS                      | 125 | DM0                     | 165 | NC       | 205 | DQ38                    |
| 6   | $\overline{\text{DQS}}0$ | 46  | NC(DQS8)*                                       | 86  | DQ34                     | 126 | NC                      | 166 | VSS      | 206 | DQ39                    |
| 7   | DQS0                     | 47  | VSS   | 87  | DQ35                     | 127 | VSS                     | 167 | NC(CB6)* | 207 | VSS                     |
| 8   | VSS                      | 48  | NC(CB2)*  | 88  | VSS                      | 128 | DQ6                     | 168 | NC(CB7)* | 208 | DQ44                    |
| 9   | DQ2                      | 49  | NC(CB3)*  | 89  | DQ40                     | 129 | DQ7                     | 169 | VSS      | 209 | DQ45                    |
| 10  | DQ3                      | 50  | VSS   | 90  | DQ41                     | 130 | VSS                     | 170 | VDDQ     | 210 | VSS                     |
| 11  | VSS                      | 51  | VDDQ  | 91  | VSS                      | 131 | DQ12                    | 171 | CKE1     | 211 | DM5                     |
| 12  | DQ8                      | 52  | CKE0  | 92  | $\overline{\text{DQS}}5$ | 132 | DQ13                    | 172 | VDD      | 212 | NC                      |
| 13  | DQ9                      | 53  | VDD   | 93  | DQS5                     | 133 | VSS                     | 173 | A15      | 213 | VSS                     |
| 14  | VSS                      | 54  | BA2   | 94  | VSS                      | 134 | DM1                     | 174 | A14      | 214 | DQ46                    |
| 15  | $\overline{\text{DQS}}1$ | 55  | NC  | 95  | DQ42                     | 135 | NC                      | 175 | VDDQ     | 215 | DQ47                    |
| 16  | DQS1                     | 56  | VDDQ  | 96  | DQ43                     | 136 | VSS                     | 176 | A12      | 216 | VSS                     |
| 17  | VSS                      | 57  | A11   | 97  | VSS                      | 137 | CK1                     | 177 | A9       | 217 | DQ52                    |
| 18  | NC                       | 58  | A7  | 98  | DQ48                     | 138 | $\overline{\text{CK}}1$ | 178 | VDD      | 218 | DQ53                    |
| 19  | NC                       | 59  | VDD   | 99  | DQ49                     | 139 | VSS                     | 179 | A8       | 219 | VSS                     |
| 20  | VSS                      | 60  | A5  | 100 | VSS                      | 140 | DQ14                    | 180 | A6       | 220 | CK2                     |
| 21  | DQ10                     | 61  | A4  | 101 | SA2                      | 141 | DQ15                    | 181 | VDDQ     | 221 | $\overline{\text{CK}}2$ |
| 22  | DQ11                     | 62  | VDDQ  | 102 | NC, TEST <sup>1</sup>    | 142 | VSS                     | 182 | A3       | 222 | VSS                     |

\* The pin names in parentheses are applied to DIMM with ECC only.

**PIN ASSIGNMENT(Continued)**

| Pin | Name | Pin | Name   | Pin | Name | Pin | Name | Pin | Name | Pin | Name   |
|-----|------|-----|--------|-----|------|-----|------|-----|------|-----|--------|
| 23  | VSS  | 63  | A2     | 103 | VSS  | 143 | DQ20 | 183 | A1   | 223 | DM6    |
| 24  | DQ16 | 64  | VDD    | 104 | DQS6 | 144 | DQ21 | 184 | VDD  | 224 | NC     |
| 25  | DQ17 | 65  | VSS    | 105 | DQS6 | 145 | VSS  | 185 | CK0  | 225 | VSS    |
| 26  | VSS  | 66  | VSS    | 106 | VSS  | 146 | DM2  | 186 | CK0  | 226 | DQ54   |
| 27  | DQS2 | 67  | VDD    | 107 | DQ50 | 147 | NC   | 187 | VDD  | 227 | DQ55   |
| 28  | DQS2 | 68  | NC     | 108 | DQ51 | 148 | VSS  | 188 | A0   | 228 | VSS    |
| 29  | VSS  | 69  | VDD    | 109 | VSS  | 149 | DQ22 | 189 | VDD  | 229 | DQ60   |
| 30  | DQ18 | 70  | A10/AP | 110 | DQ56 | 150 | DQ23 | 190 | BA1  | 230 | DQ61   |
| 31  | DQ19 | 71  | BA0    | 111 | DQ57 | 151 | VSS  | 191 | VDDQ | 231 | VSS    |
| 32  | VSS  | 72  | VDDQ   | 112 | VSS  | 152 | DQ28 | 192 | RAS  | 232 | DM7    |
| 33  | DQ24 | 73  | WE     | 113 | DQS7 | 153 | DQ29 | 193 | S0   | 233 | NC     |
| 34  | DQ25 | 74  | CAS    | 114 | DQS7 | 154 | VSS  | 194 | VDDQ | 234 | VSS    |
| 35  | VSS  | 75  | VDDQ   | 115 | VSS  | 155 | DM3  | 195 | ODT0 | 235 | DQ62   |
| 36  | DQS3 | 76  | S1     | 116 | DQ58 | 156 | NC   | 196 | A13  | 236 | DQ63   |
| 37  | DQS3 | 77  | ODT1   | 117 | DQ59 | 157 | VSS  | 197 | VDD  | 237 | VSS    |
| 38  | VSS  | 78  | VDDQ   | 118 | VSS  | 158 | DQ30 | 198 | VSS  | 238 | VDDSPD |
| 39  | DQ26 | 79  | VSS    | 119 | SDA  | 159 | DQ31 | 199 | DQ36 | 239 | SA0    |
| 40  | DQ27 | 80  | DQ32   | 120 | SCL  | 160 | VSS  | 200 | DQ37 | 240 | SA1    |

\*NC=No connect

**Note :**

1. The TEST pin is reserved for bus analysis tools and is not connected on standard memory module products(DIMMs).
2. NC Pins should not be connected to anything, including bussing within the NC group.

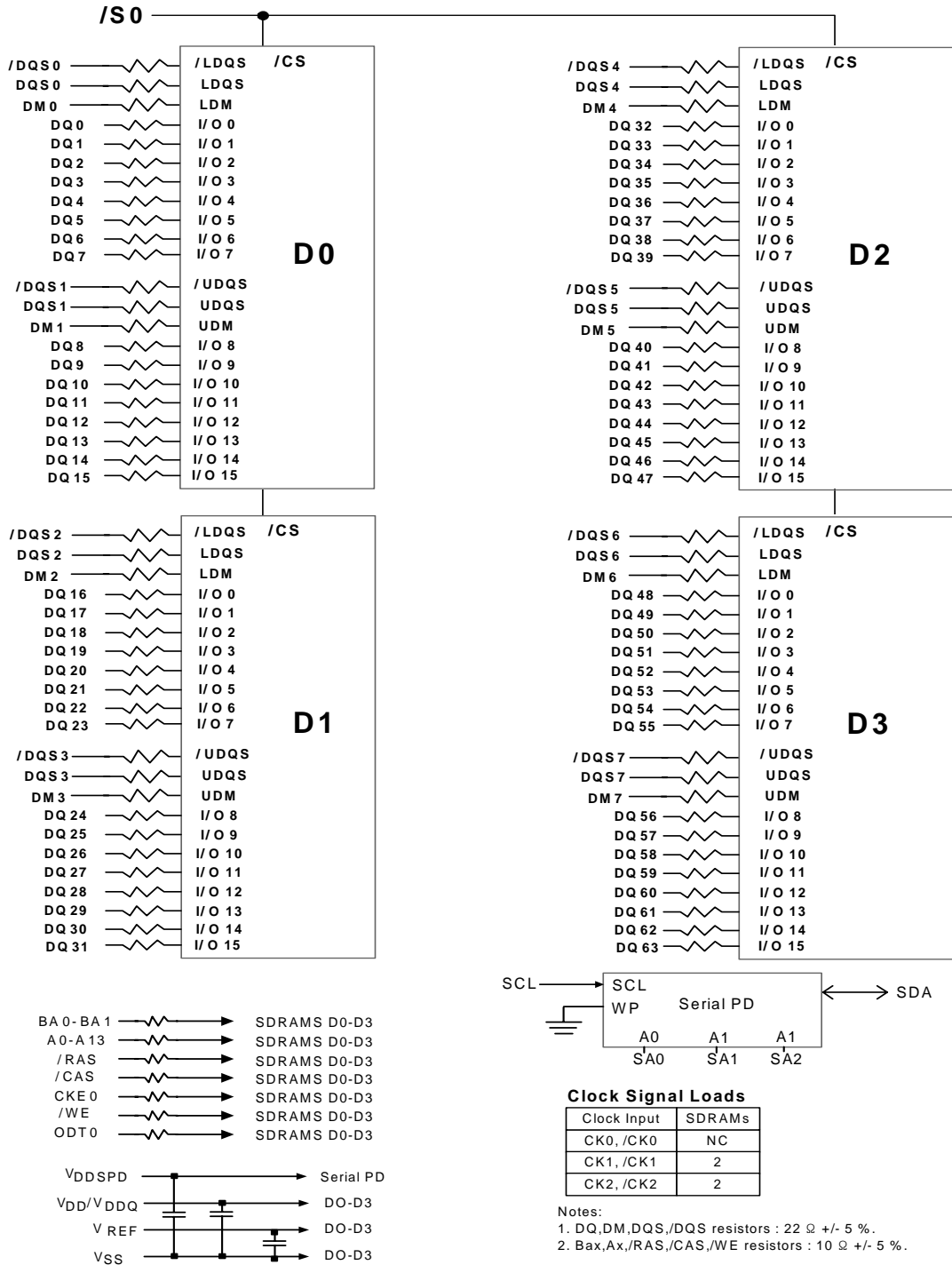
**FUNCTIONAL BLOCK DIAGRAM**  
 256MB(32Mbx64) : HYMP532U64BP6

## FUNCTIONAL BLOCK DIAGRAM 512MB(64Mbx64) : HYMP564U64BP8

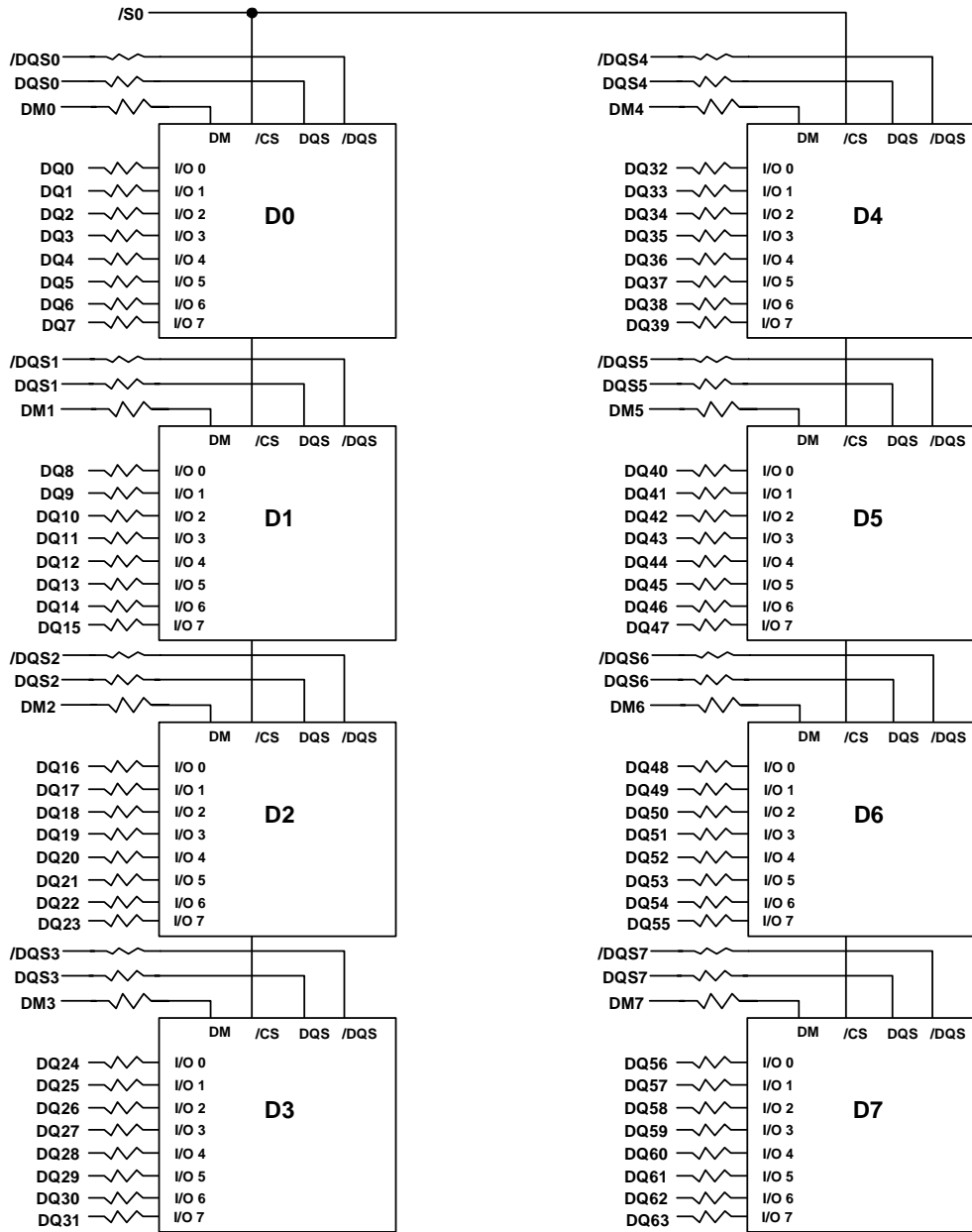

- BA0-BA1 → SDRAMs D0-7
- A0-A13 → SDRAMs D0-7
- /RAS → SDRAMs D0-7
- /CAS → SDRAMs D0-7
- CKE0 → SDRAMs D0-7
- /WE → SDRAMs D0-7
- ODT0 → SDRAMs D0-7

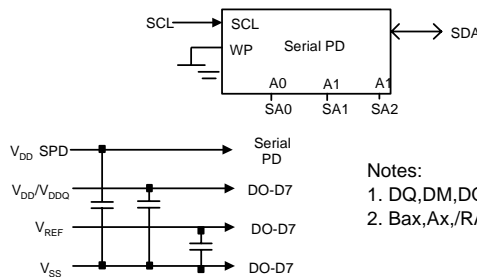

### Clock Signal Loads

| Clock Input | SDRAMs |
|-------------|--------|
| CK0, /CK0   | 2      |
| CK1, /CK1   | 3      |
| CK2, /CK2   | 3      |

- Notes:
1. DQ,DM,DQS,/DQS resistors : 22 Ω +/- 5 %.
  2. BAx,Ax,/RAS,/CAS,/WE resistors : 5.1 Ω +/- 5 %.

## FUNCTIONAL BLOCK DIAGRAM 512MB(64Mbx72) : HYMP564U72BP8

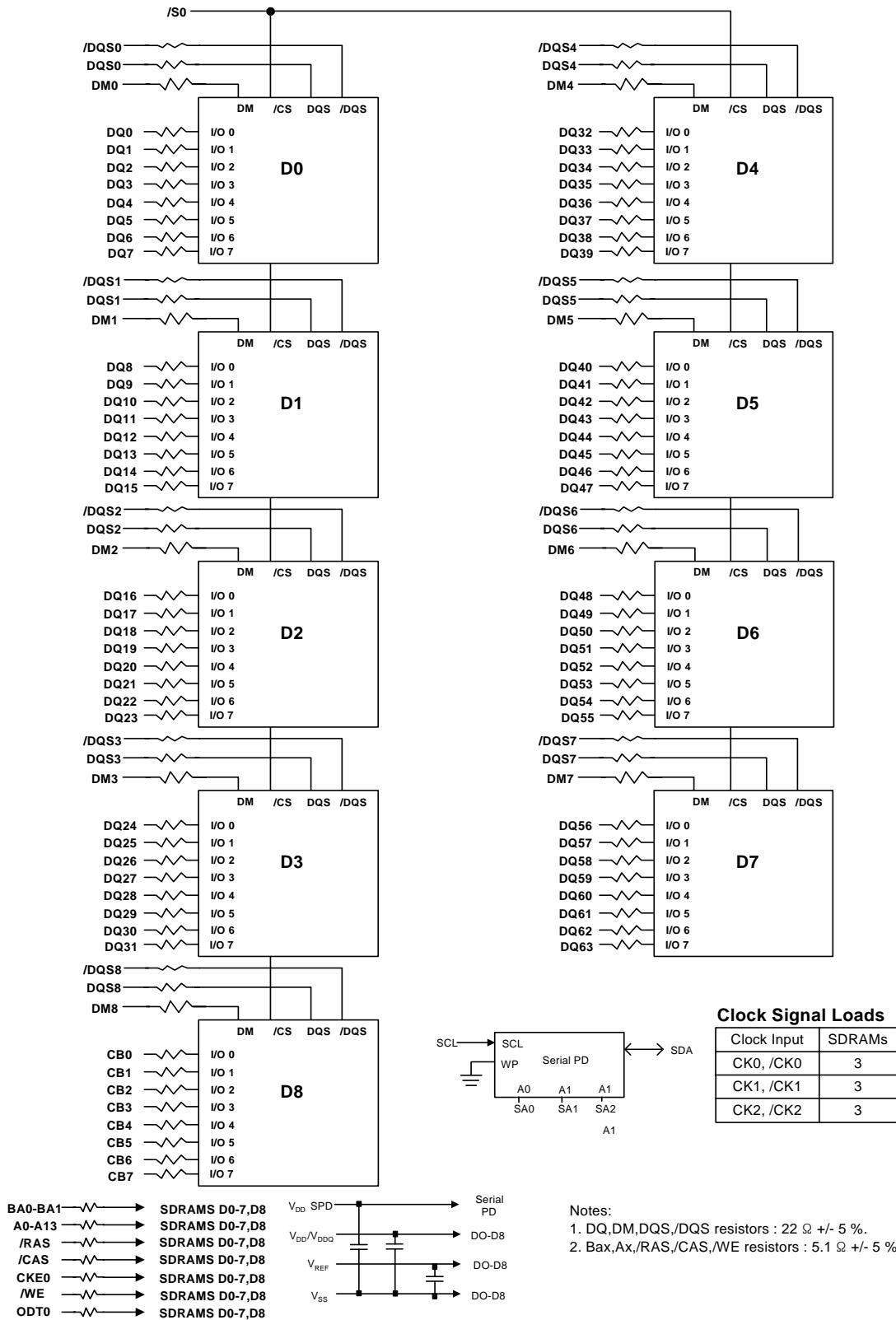



## FUNCTIONAL BLOCK DIAGRAM 1GB(128Mbx64) : HYMP512U64BP8

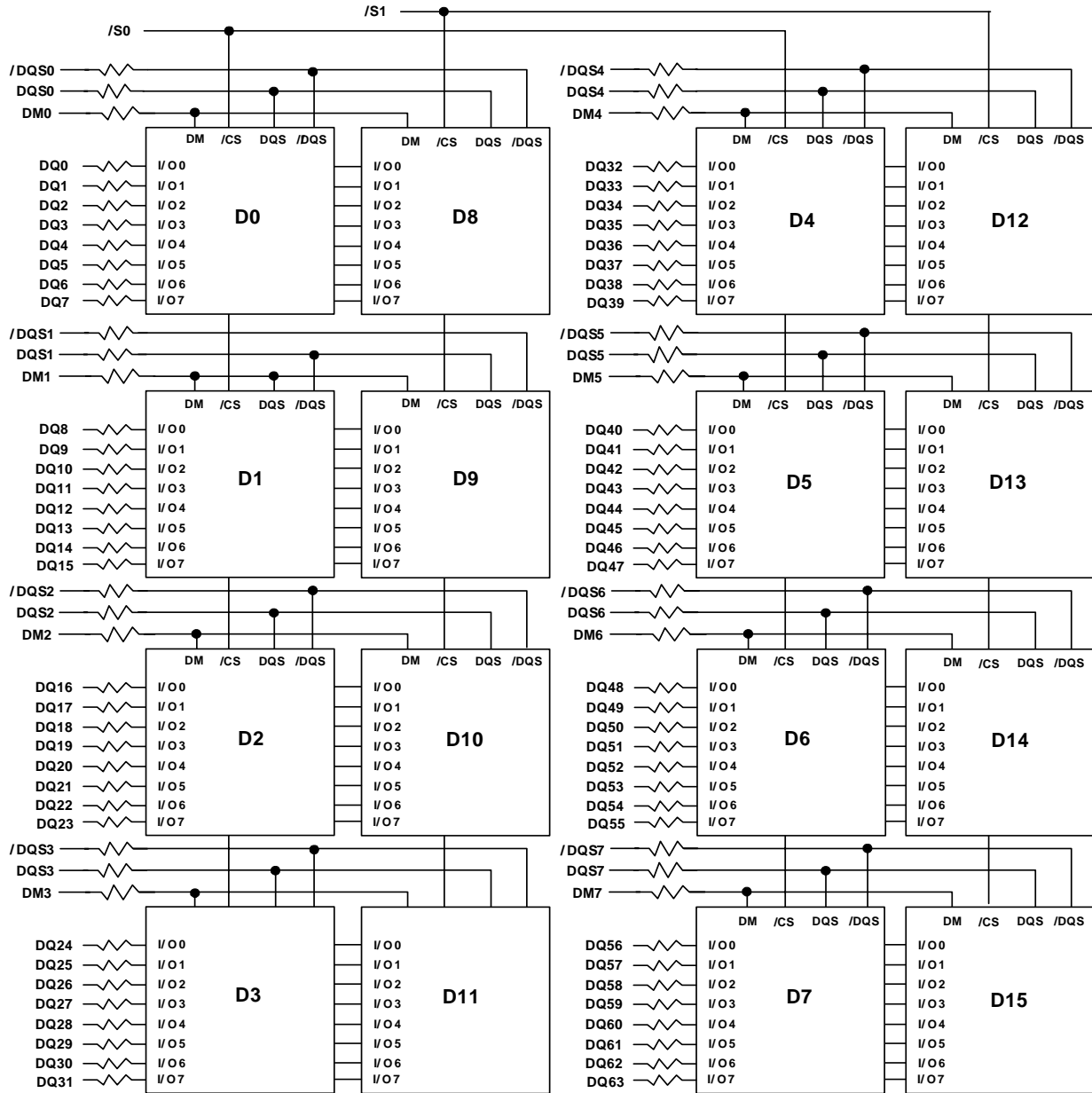

- BA0-BA1 → SDRAMs D0-D15
- A0-A15 → SDRAMs D0-D15
- CKE0 → SDRAMs D0-D7
- CKE1 → SDRAMs D8-D15
- /CAS → SDRAMs D0-D15
- /RAS → SDRAMs D0-D15
- /WE → SDRAMs D0-D15
- ODT0 → SDRAMs D0-D7
- ODT1 → SDRAMs D8-D15

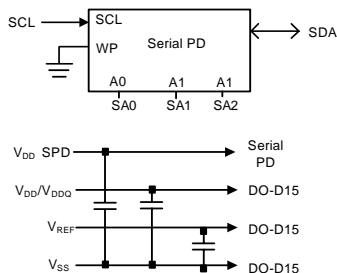

### Clock Signal Loads

| Clock Input | SDRAMs |
|-------------|--------|
| CK0, /CK0   | 4      |
| CK1, /CK1   | 6      |
| CK2, /CK2   | 6      |

- Notes:
1. DQ,DM,DQS,/DQS resistors : 22 Ω +/- 5 %.
  2. BAx,Ax,/RAS,/CAS,/WE resistors : 7.5 Ω +/- 5 %.

## FUNCTIONAL BLOCK DIAGRAM 1GB(128Mbx72) : HYMP512U72BP8

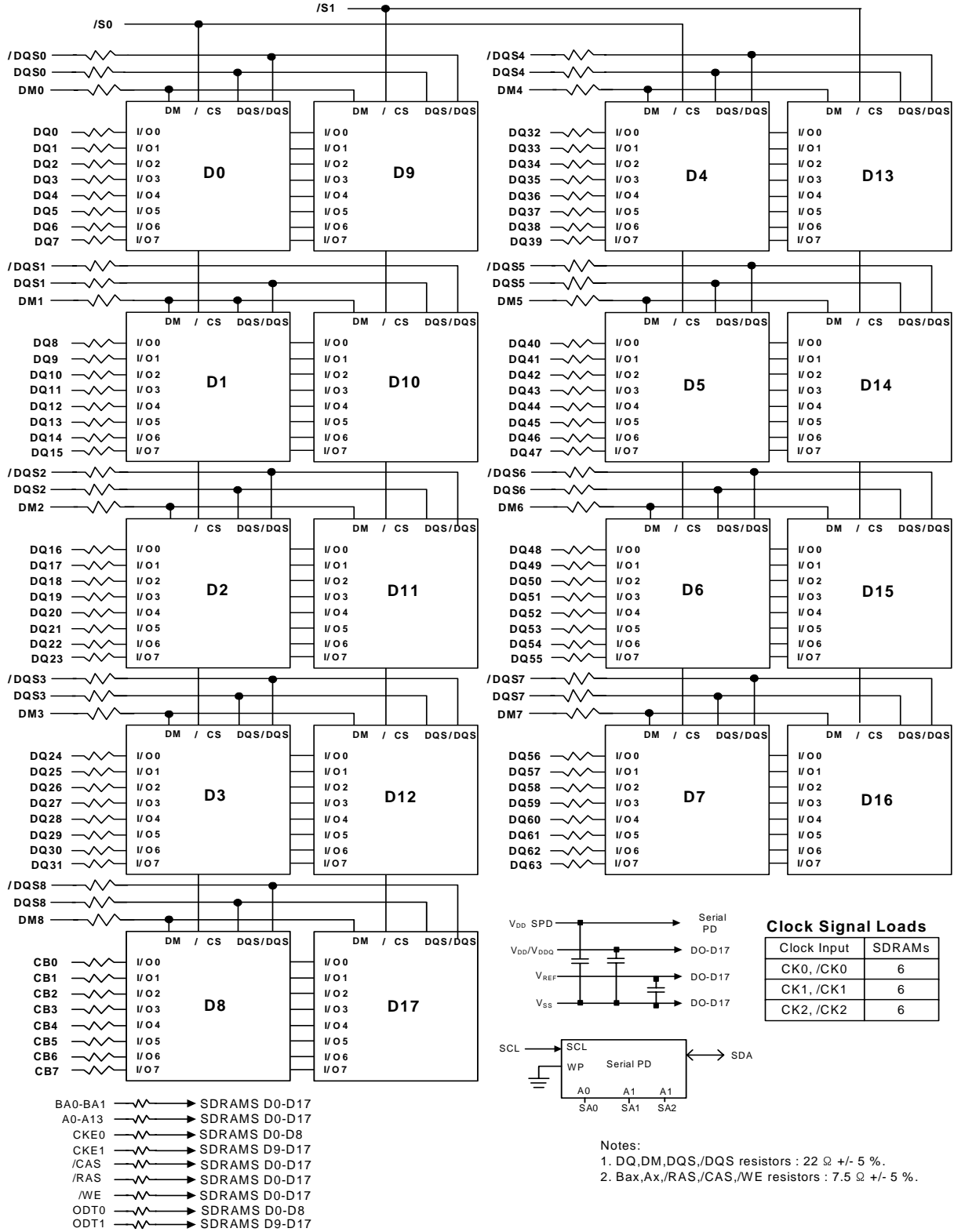

**ABSOLUTE MAXIMUM RATINGS**

| Parameter   | Symbol                             | Value           | Unit | Note |
|---|------------------------------------|-----------------|------|------|
| Voltage on V <sub>DD</sub> pin relative to V <sub>ss</sub>  | V <sub>DD</sub>                    | - 1.0 V ~ 2.3 V | V    | 1    |
| Voltage on V <sub>DDQ</sub> pin relative to V <sub>ss</sub> | V <sub>DDQ</sub>                   | - 0.5 V ~ 2.3 V | V    | 1    |
| Voltage on any pin relative to V <sub>ss</sub>              | V <sub>IN</sub> , V <sub>OUT</sub> | - 0.5 V ~ 2.3 V | V    | 1    |
| Storage Temperature   | T <sub>STG</sub>                   | -50 ~ +100      | °C   | 1    |
| Storage Humidity(without condensation)                      | H <sub>STG</sub>                   | 5 to 95         | %    | 1    |

**Note :**

1. Stress greater than those listed may cause permanent damage to the device. This is a stress rating only, and device functional operation at or above the conditions indicated is not implied. Exposure to absolute maximum rating conditions for extended periods may affect reliability.

**OPERATING CONDITIONS**

| Parameter                                     | Symbol            | Rating    | Units    | Notes |
|---|-------------------|-----------|----------|-------|
| DIMM Operating temperature(ambient)           | T <sub>OPR</sub>  | 0 ~ +55   | °C       |       |
| DIMM Barometric Pressure(operating & storage) | p <sub>BAR</sub>  | 105 to 69 | K Pascal | 1     |
| DRAM Component Case Temperature Range         | T <sub>CASE</sub> | 0 ~+95    | °C       | 2     |

**Note :**

1. Up to 9850 ft.
2. If the DRAM case temperature is Above 85°C, the Auto-Refresh command interval has to be reduced to tREFI=3.9us. For Measurement conditions of T<sub>CASE</sub>, please refer to the JEDEC document JESD51-2.

**DC OPERATING CONDITIONS (SSTL\_1.8)**

| Parameter   | Symbol             | Min                     | Max                     | Unit | Note |
|---|--------------------|-------------------------|-------------------------|------|------|
| Power Supply Voltage  | V <sub>DD</sub>    | 1.7                     | 1.9                     | V    |      |
|   | V <sub>DDQ</sub>   | 1.7                     | 1.9                     | V    | 1    |
| Input Reference Voltage   | V <sub>REF</sub>   | 0.49 x V <sub>DDQ</sub> | 0.51 x V <sub>DDQ</sub> | V    | 2    |
| EEPROM Supply Voltage   | V <sub>DDSPD</sub> | 1.7                     | 3.6                     | V    |      |
| Termination Voltage   | V <sub>TT</sub>    | V <sub>REF</sub> -0.04  | V <sub>REF</sub> +0.04  | V    | 3    |
| Input leakage current; any input 0V VIN VDD; all other balls not under test = 0V) | I <sub>I</sub>     | -2                      | 2                       | uA   |      |
| Output leakage current; 0V VOUT VDDQ; DQ and ODT disabled                         | I <sub>OZ</sub>    | -5                      | 5                       | uA   |      |

**Note :**

1. V<sub>DDQ</sub> must be less than or equal to V<sub>DD</sub>.
2. Peak to peak ac noise on V<sub>REF</sub> may not exceed +/-2% V<sub>REF</sub>(dc)
3. V<sub>TT</sub> of transmitting device must track V<sub>REF</sub> of receiving device.

**INPUT DC LOGIC LEVEL**

| Parameter          | Symbol       | Min               | Max               | Unit | Note |
|--------------------|--------------|-------------------|-------------------|------|------|
| Input High Voltage | $V_{IH(DC)}$ | $V_{REF} + 0.125$ | $V_{DDQ} + 0.3$   | V    |      |
| Input Low Voltage  | $V_{IL(DC)}$ | -0.30             | $V_{REF} - 0.125$ | V    |      |

**INPUT AC LOGIC LEVEL**

| Parameter           | Symbol       | DDR2 400, 533     |                   | DDR2 667, 800     |                   | Unit | Note |
|---------------------|--------------|-------------------|-------------------|-------------------|-------------------|------|------|
|                     |              | Min               | Max               | Min               | Max               |      |      |
| AC Input logic High | $V_{IH(AC)}$ | $V_{REF} + 0.250$ | -                 | $V_{REF} + 0.200$ | -                 | V    |      |
| AC Input logic Low  | $V_{IL(AC)}$ | -                 | $V_{REF} - 0.250$ | -                 | $V_{REF} - 0.200$ | V    |      |

**AC INPUT TEST CONDITIONS**

| Symbol           | Condition                               | Value           | Units | Notes |
|------------------|---|-----------------|-------|-------|
| $V_{REF}$        | Input reference voltage                 | $0.5 * V_{DDQ}$ | V     | 1     |
| $V_{SWING(MAX)}$ | Input signal maximum peak to peak swing | 1.0             | V     | 1     |
| SLEW             | Input signal minimum slew rate          | 1.0             | V/ns  | 2, 3  |

**Note:**

- Input waveform timing is referenced to the input signal crossing through the  $V_{REF}$  level applied to the device under test.
- The input signal minimum slew rate is to be maintained over the range from  $V_{REF}$  to  $V_{IH(ac)}$  min for rising edges and the range from  $V_{REF}$  to  $V_{IL(ac)}$  max for falling edges as shown in the below figure.
- AC timings are referenced with input waveforms switching from  $V_{IL(ac)}$  to  $V_{IH(ac)}$  on the positive transitions and  $V_{IH(ac)}$  to  $V_{IL(ac)}$  on the negative transitions.

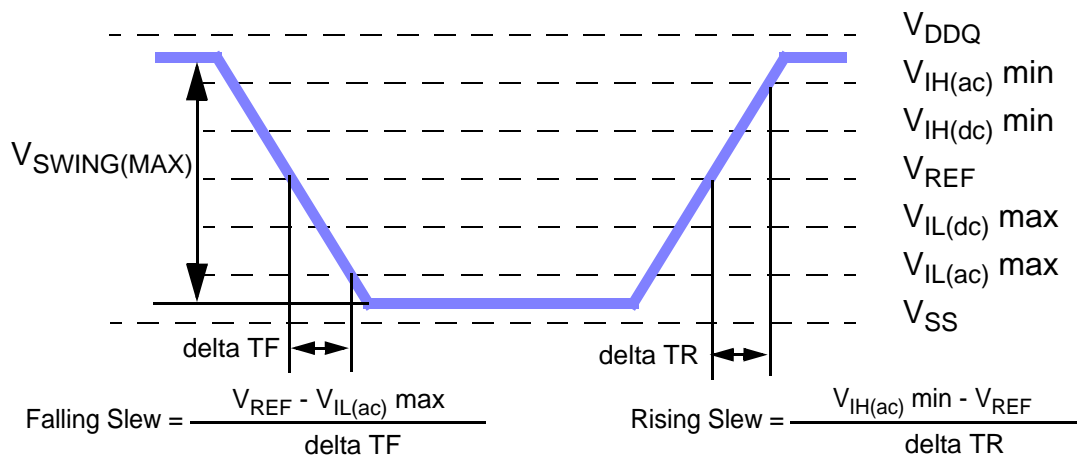

&lt; Figure : AC Input Test Signal Waveform &gt;

## Differential Input AC logic Level

| Symbol        | Parameter                           | Min.                    | Max.                    | Units | Note |
|---------------|-------------------------------------|-------------------------|-------------------------|-------|------|
| $V_{ID} (ac)$ | ac differential input voltage       | 0.5                     | $V_{DDQ} + 0.6$         | V     | 1    |
| $V_{IX} (ac)$ | ac differential cross point voltage | $0.5 * V_{DDQ} - 0.175$ | $0.5 * V_{DDQ} + 0.175$ | V     | 2    |

- $V_{IN}(DC)$  specifies the allowable DC execution of each input of differential pair such as CK,  $\overline{CK}$ , DQS,  $\overline{DQS}$ , LDQS,  $\overline{LDQS}$ , UDQS and  $\overline{UDQS}$ .
- $V_{ID}(DC)$  specifies the input differential voltage  $|V_{TR} - V_{CP}|$  required for switching, where  $V_{TR}$  is the true input (such as CK, DQS, LDQS or UDQS) level and  $V_{CP}$  is the complementary input (such as  $\overline{CK}$ ,  $\overline{DQS}$ ,  $\overline{LDQS}$  or  $\overline{UDQS}$ ) level. The minimum value is equal to  $V_{IH}(DC) - V_{IL}(DC)$ .

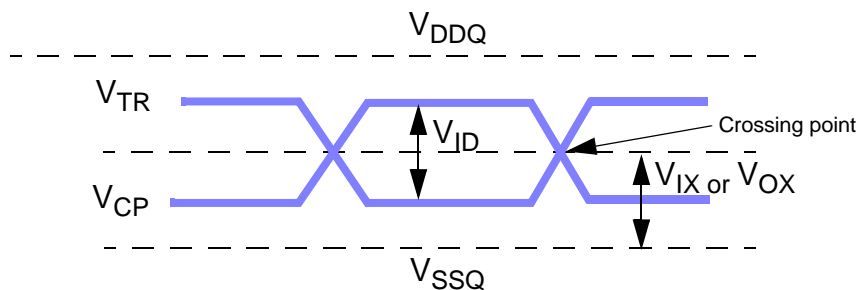

< Differential signal levels >

### Note:

- $V_{ID}(AC)$  specifies the input differential voltage  $|V_{TR} - V_{CP}|$  required for switching, where  $V_{TR}$  is the true input signal (such as CK, DQS, LDQS or UDQS) and  $V_{CP}$  is the complementary input signal (such as  $\overline{CK}$ ,  $\overline{DQS}$ ,  $\overline{LDQS}$  or  $\overline{UDQS}$ ). The minimum value is equal to  $V_{IH}(AC) - V_{IL}(AC)$ .
- The typical value of  $V_{IX}(AC)$  is expected to be about  $0.5 * V_{DDQ}$  of the transmitting device and  $V_{IX}(AC)$  is expected to track variations in  $V_{DDQ}$ .  $V_{IX}(AC)$  indicates the voltage at which differential input signals must cross.

## DIFFERENTIAL AC OUTPUT PARAMETERS

| Symbol        | Parameter                           | Min.                    | Max.                    | Units | Note |
|---------------|-------------------------------------|-------------------------|-------------------------|-------|------|
| $V_{OX} (ac)$ | ac differential cross point voltage | $0.5 * V_{DDQ} - 0.125$ | $0.5 * V_{DDQ} + 0.125$ | V     | 1    |

### Note:

- The typical value of  $V_{OX}(AC)$  is expected to be about  $0.5 * V_{DDQ}$  of the transmitting device and  $V_{OX}(AC)$  is expected to track variations in  $V_{DDQ}$ .  $V_{OX}(AC)$  indicates the voltage at which differential output signals must cross.

## OUTPUT BUFFER LEVELS

### OUTPUT AC TEST CONDITIONS

| Symbol    | Parameter                                 | SSTL_18         | Units | Notes |
|-----------|---|-----------------|-------|-------|
| $V_{OTR}$ | Output Timing Measurement Reference Level | $0.5 * V_{DDQ}$ | V     | 1     |

**Note:**

1. The VDDQ of the device under test is referenced.

### OUTPUT DC CURRENT DRIVE

| Symbol       | Parameter                        | SSTL_18 | Units | Notes   |
|--------------|----------------------------------|---------|-------|---------|
| $I_{OH(dc)}$ | Output Minimum Source DC Current | - 13.4  | mA    | 1, 3, 4 |
| $I_{OL(dc)}$ | Output Minimum Sink DC Current   | 13.4    | mA    | 2, 3, 4 |

**Note:**

1.  $V_{DDQ} = 1.7\text{ V}$ ;  $V_{OUT} = 1420\text{ mV}$ .  $(V_{OUT} - V_{DDQ})/I_{OH}$  must be less than 21 ohm for values of  $V_{OUT}$  between  $V_{DDQ}$  and  $V_{DDQ} - 280\text{ mV}$ .
2.  $V_{DDQ} = 1.7\text{ V}$ ;  $V_{OUT} = 280\text{ mV}$ .  $V_{OUT}/I_{OL}$  must be less than 21 ohm for values of  $V_{OUT}$  between 0 V and 280 mV.
3. The dc value of  $V_{REF}$  applied to the receiving device is set to  $V_{TT}$
4. The values of  $I_{OH(dc)}$  and  $I_{OL(dc)}$  are based on the conditions given in Notes 1 and 2. They are used to test device drive current capability to ensure  $V_{IH}$  min plus a noise margin and  $V_{IL}$  max minus a noise margin are delivered to an SSTL\_18 receiver. The actual current values are derived by shifting the desired driver operating point along a 21 ohm load line to define a convenient driver current for measurement.

**PIN Capacitance** (VDD=1.8V, VDDQ=1.8V, TA=25°C, f=1MHz)

**256MB : HYMP532U64BP6**

| Pin  | Symbol | Min | Max | Unit |
|--|--------|-----|-----|------|
| CK, $\overline{CK}$  | CCK    | 18  | 22  | pF   |
| CKE, ODT, CS   | CI1    | 57  | 63  | pF   |
| Address, $\overline{RAS}$ , $\overline{CAS}$ , $\overline{WE}$ | CI2    | 42  | 48  | pF   |
| DQ, DM, DQS, $\overline{DQS}$                                  | CIO    | 7   | 9   | pF   |

**512MB : HYMP564U64BP8**

| Pin  | Symbol | Min | Max | Unit |
|--|--------|-----|-----|------|
| CK, $\overline{CK}$  | CCK    | 22  | 30  | pF   |
| CKE, ODT, CS   | CI1    | 62  | 84  | pF   |
| Address, $\overline{RAS}$ , $\overline{CAS}$ , $\overline{WE}$ | CI2    | 42  | 64  | pF   |
| DQ, DM, DQS, $\overline{DQS}$                                  | CIO    | 6   | 9   | pF   |

**512MB : HYMP564U72BP8**

| Pin  | Symbol | Min | Max | Unit |
|--|--------|-----|-----|------|
| CK, $\overline{CK}$  | CCK    | 22  | 30  | pF   |
| CKE, ODT, CS   | CI1    | 63  | 85  | pF   |
| Address, $\overline{RAS}$ , $\overline{CAS}$ , $\overline{WE}$ | CI2    | 43  | 66  | pF   |
| DQ, DM, DQS, $\overline{DQS}$                                  | CIO    | 6   | 9   | pF   |

**1GB : HYMP512U64BP8**

| Pin  | Symbol | Min | Max | Unit |
|--|--------|-----|-----|------|
| CK, $\overline{CK}$  | CCK    | 22  | 35  | pF   |
| CKE, ODT, CS   | CI1    | 64  | 87  | pF   |
| Address, $\overline{RAS}$ , $\overline{CAS}$ , $\overline{WE}$ | CI2    | 50  | 88  | pF   |
| DQ, DM, DQS, $\overline{DQS}$                                  | CIO    | 8   | 13  | pF   |

**1GB : HYMP512U72BP8**

| Pin  | Symbol | Min | Max | Unit |
|--|--------|-----|-----|------|
| CK, $\overline{CK}$  | CCK    | 23  | 35  | pF   |
| CKE, ODT, CS   | CI1    | 65  | 89  | pF   |
| Address, $\overline{RAS}$ , $\overline{CAS}$ , $\overline{WE}$ | CI2    | 52  | 92  | pF   |
| DQ, DM, DQS, $\overline{DQS}$                                  | CIO    | 9   | 13  | pF   |

**Note :**

1. Pins not under test are tied to GND.
2. These value are guaranteed by design and tested on a sample basis only.

**IDD SPECIFICATIONS**( $T_{CASE} : 0 \text{ to } 95^{\circ}\text{C}$ )

**256MB, 32M x 64 U-DIMM : HYMP532U64BP6**

| Symbol   | DDR2 400 | DDR2 533 | DDR2 667 | Unit | note |
|----------|----------|----------|----------|------|------|
| IDD0     | 440      | 460      | 480      | mA   |      |
| IDD1     | 520      | 540      | 560      | mA   |      |
| IDD2P    | 32       | 32       | 32       | mA   |      |
| IDD2Q    | 160      | 180      | 200      | mA   |      |
| IDD2N    | 180      | 200      | 220      | mA   |      |
| IDD3P(F) | 120      | 120      | 140      | mA   |      |
| IDD3P(S) | 48       | 48       | 48       | mA   |      |
| IDD3N    | 200      | 240      | 260      | mA   |      |
| IDD4W    | 840      | 1000     | 1120     | mA   |      |
| IDD4R    | 800      | 880      | 1000     | mA   |      |
| IDD5B    | 640      | 680      | 720      | mA   |      |
| IDD6     | 20       | 20       | 20       | mA   | 1    |
| IDD7     | 1320     | 1340     | 1360     | mA   |      |

**512MB, 64M x 64 U - DIMM : HYMP564U64BP8**

| Symbol   | DDR2 400 | DDR2 533 | DDR2 667 | DDR2 800 | Unit | note |
|----------|----------|----------|----------|----------|------|------|
| IDD0     | 640      | 640      | 720      | 800      | mA   |      |
| IDD1     | 720      | 720      | 760      | 840      | mA   |      |
| IDD2P    | 64       | 64       | 64       | 64       | mA   |      |
| IDD2Q    | 240      | 320      | 360      | 400      | mA   |      |
| IDD2N    | 280      | 360      | 400      | 440      | mA   |      |
| IDD3P(F) | 240      | 240      | 280      | 280      | mA   |      |
| IDD3P(S) | 96       | 96       | 96       | 96       | mA   |      |
| IDD3N    | 400      | 440      | 480      | 528      | mA   |      |
| IDD4W    | 1120     | 1360     | 1520     | 1760     | mA   |      |
| IDD4R    | 1040     | 1200     | 1440     | 1680     | mA   |      |
| IDD5B    | 1280     | 1360     | 1440     | 1600     | mA   |      |
| IDD6     | 40       | 40       | 40       | 40       | mA   | 1    |
| IDD7     | 1760     | 1760     | 1760     | 2160     | mA   |      |

**Note** : 1. IDD6 current values are guaranteed up to Tcase of 85°C max.



**512MB, 64M x 72 ECC U - DIMM : HYMP564U72BP8**

| Symbol   | DDR2 400 | DDR2 533 | DDR2 667 | DDR2 800 | Unit | note |
|----------|----------|----------|----------|----------|------|------|
| IDD0     | 720      | 720      | 810      | 900      | mA   |      |
| IDD1     | 810      | 810      | 855      | 945      | mA   |      |
| IDD2P    | 72       | 72       | 72       | 72       | mA   |      |
| IDD2Q    | 270      | 360      | 405      | 450      | mA   |      |
| IDD2N    | 315      | 405      | 450      | 495      | mA   |      |
| IDD3P(F) | 270      | 270      | 315      | 315      | mA   |      |
| IDD3P(S) | 108      | 108      | 108      | 108      | mA   |      |
| IDD3N    | 450      | 495      | 540      | 594      | mA   |      |
| IDD4W    | 1260     | 1530     | 1710     | 1980     | mA   |      |
| IDD4R    | 1170     | 1350     | 1620     | 1890     | mA   |      |
| IDD5B    | 1440     | 1530     | 1620     | 1800     | mA   |      |
| IDD6     | 45       | 45       | 45       | 45       | mA   | 1    |
| IDD7     | 1980     | 1980     | 1980     | 2430     | mA   |      |

**1GB, 128M x 64 U - DIMM : HYMP512U64BP8**

| Symbol   | DDR2 400 | DDR2 533 | DDR2 667 | DDR2 800 | Unit | note |
|----------|----------|----------|----------|----------|------|------|
| IDD0     | 1040     | 1080     | 1200     | 1328     | mA   |      |
| IDD1     | 1120     | 1160     | 1240     | 1368     | mA   |      |
| IDD2P    | 128      | 128      | 128      | 128      | mA   |      |
| IDD2Q    | 480      | 640      | 720      | 800      | mA   |      |
| IDD2N    | 560      | 720      | 800      | 880      | mA   |      |
| IDD3P(F) | 480      | 480      | 560      | 560      | mA   |      |
| IDD3P(S) | 192      | 192      | 192      | 192      | mA   |      |
| IDD3N    | 800      | 880      | 960      | 1056     | mA   |      |
| IDD4W    | 1520     | 1800     | 2000     | 2288     | mA   |      |
| IDD4R    | 1440     | 1640     | 1920     | 2208     | mA   |      |
| IDD5B    | 1680     | 1800     | 1920     | 2128     | mA   |      |
| IDD6     | 80       | 80       | 80       | 80       | mA   | 1    |
| IDD7     | 2160     | 2200     | 2240     | 2688     | mA   |      |

**Note** : 1. IDD6 current values are guaranteed up to Tcase of 85°C max.

**1GB, 128M x 72 ECC U - DIMM : HYMP512U72BP8**

| Symbol   | DDR2 400 | DDR2 533 | DDR2 667 | DDR2 800 | Unit | note |
|----------|----------|----------|----------|----------|------|------|
| IDD0     | 1170     | 1215     | 1350     | 1494     | mA   |      |
| IDD1     | 1260     | 1305     | 1395     | 1539     | mA   |      |
| IDD2P    | 144      | 144      | 144      | 144      | mA   |      |
| IDD2Q    | 540      | 720      | 810      | 900      | mA   |      |
| IDD2N    | 630      | 810      | 900      | 990      | mA   |      |
| IDD3P(F) | 540      | 540      | 630      | 630      | mA   |      |
| IDD3P(S) | 216      | 216      | 216      | 216      | mA   |      |
| IDD3N    | 900      | 990      | 1080     | 1188     | mA   |      |
| IDD4W    | 1710     | 2025     | 2250     | 2574     | mA   |      |
| IDD4R    | 1620     | 1845     | 2160     | 2484     | mA   |      |
| IDD5B    | 1890     | 2025     | 2160     | 2394     | mA   |      |
| IDD6     | 90       | 90       | 90       | 90       | mA   | 1    |
| IDD7     | 2430     | 2475     | 2520     | 3024     | mA   |      |

**Note** : 1. IDD6 current values are guaranteed up to Tcase of 85°C max.

**IDD MEASUREMENT CONDITIONS**

| Symbol | Conditions   | Units                     |
|--------|--|---------------------------|
| IDD0   | <b>Operating one bank active-precharge current</b> ; $t_{CK} = t_{CK}(IDD)$ , $t_{RC} = t_{RC}(IDD)$ , $t_{RAS} = t_{RAS-min}(IDD)$ ; CKE is HIGH, $\overline{CS}$ is HIGH between valid commands; Address bus inputs are SWITCHING; Data bus inputs are SWITCHING   | mA                        |
| IDD1   | <b>Operating one bank active-read-precharge current</b> ; $I_{OUT} = 0mA$ ; $BL = 4$ , $CL = CL(IDD)$ , $AL = 0$ ; $t_{CK} = t_{CK}(IDD)$ , $t_{RC} = t_{RC}(IDD)$ , $t_{RAS} = t_{RASmin}(IDD)$ , $t_{RCD} = t_{RCD}(IDD)$ ; CKE is HIGH, $\overline{CS}$ is HIGH between valid commands ; Address bus inputs are SWITCHING ; Data pattern is same as IDD4W   | mA                        |
| IDD2P  | <b>Precharge power-down current</b> ; All banks idle ; $t_{CK} = t_{CK}(IDD)$ ; CKE is LOW ; Other control and address bus inputs are STABLE; Data bus inputs are FLOATING   | mA                        |
| IDD2Q  | <b>Precharge quiet standby current</b> ; All banks idle; $t_{CK} = t_{CK}(IDD)$ ; CKE is HIGH, $\overline{CS}$ is HIGH; Other control and address bus inputs are STABLE; Data bus inputs are FLOATING  | mA                        |
| IDD2N  | <b>Precharge standby current</b> ; All banks idle; $t_{CK} = t_{CK}(IDD)$ ; CKE is HIGH, $\overline{CS}$ is HIGH; Other control and address bus inputs are SWITCHING; Data bus inputs are SWITCHING  | mA                        |
| IDD3P  | <b>Active power-down current</b> ; All banks open; $t_{CK} = t_{CK}(IDD)$ ; CKE is LOW; Other control and address bus inputs are STABLE; Data bus inputs are FLOATING  | Fast PDN Exit MRS(12) = 0 |
|        |  | Slow PDN Exit MRS(12) = 1 |
| IDD3N  | <b>Active standby current</b> ; All banks open; $t_{CK} = t_{CK}(IDD)$ , $t_{RAS} = t_{RASmax}(IDD)$ , $t_{RP} = t_{RP}(IDD)$ ; CKE is HIGH, $\overline{CS}$ is HIGH between valid commands; Other control and address bus inputs are SWITCHING; Data bus inputs are SWITCHING   | mA                        |
| IDD4W  | <b>Operating burst write current</b> ; All banks open, Continuous burst writes; $BL = 4$ , $CL = CL(IDD)$ , $AL = 0$ ; $t_{CK} = t_{CK}(IDD)$ , $t_{RAS} = t_{RASmax}(IDD)$ , $t_{RP} = t_{RP}(IDD)$ ; CKE is HIGH, $\overline{CS}$ is HIGH between valid commands; Address bus inputs are SWITCHING; Data bus inputs are SWITCHING  | mA                        |
| IDD4R  | <b>Operating burst read current</b> ; All banks open, Continuous burst reads, $I_{OUT} = 0mA$ ; $BL = 4$ , $CL = CL(IDD)$ , $AL = 0$ ; $t_{CK} = t_{CK}(IDD)$ , $t_{RAS} = t_{RASmax}(IDD)$ , $t_{RP} = t_{RP}(IDD)$ ; CKE is HIGH, $\overline{CS}$ is HIGH between valid commands; Address bus inputs are SWITCHING;; Data pattern is same as IDD4W   | mA                        |
| IDD5B  | <b>Burst refresh current</b> ; $t_{CK} = t_{CK}(IDD)$ ; Refresh command at every $t_{RFC}(IDD)$ interval; CKE is HIGH, $\overline{CS}$ is HIGH between valid commands; Other control and address bus inputs are SWITCHING; Data bus inputs are SWITCHING   | mA                        |
| IDD6   | <b>Self refresh current</b> ; CK and $\overline{CK}$ at 0V; CKE $\leq 0.2V$ ; Other control and address bus inputs are FLOATING; Data bus inputs are FLOATING. IDD6 current values are guaranteed up to Tcase of 85°... max.   | Normal                    |
|        |  | Low Power                 |
| IDD7   | <b>Operating bank interleave read current</b> ; All bank interleaving reads, $I_{OUT} = 0mA$ ; $BL = 4$ , $CL = CL(IDD)$ , $AL = t_{RCD}(IDD) - 1 * t_{CK}(IDD)$ ; $t_{CK} = t_{CK}(IDD)$ , $t_{RC} = t_{RC}(IDD)$ , $t_{RRD} = t_{RRD}(IDD)$ , $t_{RCD} = 1 * t_{CK}(IDD)$ ; CKE is HIGH, $\overline{CS}$ is HIGH between valid commands; Address bus inputs are STABLE during DESELECTs; Data pattern is same as IDD4R; - Refer to the following page for detailed timing conditions | mA                        |

**Note:**

1. IDD specifications are tested after the device is properly initialized
2. Input slew rate is specified by AC Parametric Test Condition
3. IDD parameters are specified with ODT disabled.
4. Data bus consists of DQ, DM, DQS,  $\overline{DQS}$ , RDQS,  $\overline{RDQS}$ , LDQS,  $\overline{LDQS}$ , UDQS, and  $\overline{UDQS}$ . IDD values must be met with all combinations of EMRS bits 10 and 11.
5. Definitions for IDD
  - LOW is defined as  $V_{in} \leq V_{ILAC}(max)$
  - HIGH is defined as  $V_{in} \geq V_{IHAC}(min)$
  - STABLE is defined as inputs stable at a HIGH or LOW level
  - FLOATING is defined as inputs at  $V_{REF} = V_{DDQ}/2$
  - SWITCHING is defined as:
    - inputs changing between HIGH and LOW every other clock cycle (once per two clocks) for address and control signals, and inputs changing between HIGH and LOW every other data transfer (once per clock) for DQ signals not including masks or strobes.

**Electrical Characteristics & AC Timings**

Speed Bins and CL,tRCD,tRP,tRC and tRAS for Corresponding Bin

| Speed            | DDR2-800 | DDR2-800 | DDR2-667 | DDR2-667 | DDR2-533 | DDR2-400 | Unit |
|------------------|----------|----------|----------|----------|----------|----------|------|
| Bin(CL-tRCD-tRP) | 5-5-5    | 6-6-6    | 4-4-4    | 5-5-5    | 3-3-3    | 4-4-4    |      |
| Parameter        | min      | min      | min      | min      | min      | min      |      |
| CAS Latency      | 5        | 6        | 4        | 5        | 3        | 5        | ns   |
| tRCD             | 12.5     | 15       | 12       | 15       | 11.25    | 15       | ns   |
| tRP              | 12.5     | 15       | 12       | 15       | 11.25    | 15       | ns   |
| tRAS             | 45       | 45       | 45       | 45       | 45       | 40       | ns   |
| tRC              | 57.25    | 60       | 57       | 60       | 56.25    | 55       | ns   |

**AC Timing Parameters by Speed Grade**

| Parameter  | Symbol   | DDR2-400     |         | DDR2-533     |         | Unit | Note |
|--|----------|--------------|---------|--------------|---------|------|------|
|  |          | Min          | Max     | Min          | Max     |      |      |
| Data-Out edge to Clock edge Skew                       | tAC      | -600         | +600    | -500         | 500     | ps   |      |
| DQS-Out edge to Clock edge Skew                        | tDQSCK   | -500         | +500    | -500         | 450     | ns   |      |
| Clock High Level Width                                 | tCH      | 0.45         | 0.55    | 0.45         | 0.55    | CK   |      |
| Clock Low Level Width                                  | tCL      | 0.45         | 0.55    | 0.45         | 0.55    | CK   |      |
| Clock Half Period                                      | tHP      | min(tCL,tCH) | -       | min(tCL,tCH) | -       | ns   |      |
| System Clock Cycle Time                                | tCK      | 5000         | 8000    | 3750         | 8000    | ps   |      |
| DQ and DM input setup time(differential strobe)        | tDS      | 150          | -       | 100          | -       | ps   | 1    |
| DQ and DM input hold time(differential strobe)         | tDH      | 275          | -       | 225          | -       | ps   | 1    |
| DQ and DM input setup time(single ended strobe)        | tDS1     | 25           | -       | -25          | -       | ps   | 1    |
| DQ and DM input hold time(single ended strobe)         | tDH1     | 25           | -       | -25          | -       | ps   | 1    |
| Control & Address input Pulse Width for each input     | tIPW     | 0.6          | -       | 0.6          | -       | tCK  |      |
| DQ and DM input pulse width for each input             | tDIPW    | 0.35         | -       | 0.35         | -       | tCK  |      |
| Data-out high-impedance window from CK, /CK            | tHZ      | -            | tAC max | -            | tAC max | ps   |      |
| DQS low-impedance time from CK/ $\overline{\text{CK}}$ | tLZ(DQS) | tAC min      | tAC max | tAC min      | tAC max | ps   |      |
| DQ low-impedance time from CK/ $\overline{\text{CK}}$  | tLZ(DQ)  | 2*tAC min    | tAC max | 2*tAC min    | tAC max | ps   |      |
| DQS-DQ skew for DQS and associated DQ signals          | tDQSQ    | -            | 350     | -            | 300     | ps   |      |
| DQ hold skew factor                                    | tQHS     | -            | 450     | -            | 400     | ps   |      |
| DQ/DQS output hold time from DQS                       | tQH      | tHP - tQHS   | -       | tHP - tQHS   | -       | ps   |      |
| First DQS latching transition to associated clock edge | tDQSS    | -0.25        | + 0.25  | -0.25        | + 0.25  | tCK  |      |
| DQS input high pulse width                             | tDQSH    | 0.35         | -       | 0.35         | -       | tCK  |      |
| DQS input low pulse width                              | tDQSL    | 0.35         | -       | 0.35         | -       | tCK  |      |

*- continued -*

| Parameter   | Symbol               | DDR2-400   |                 | DDR2-533   |                   | Unit | Note |
|---|----------------------|------------|-----------------|------------|-------------------|------|------|
|   |                      | Min        | Max             | Min        | Max               |      |      |
| DQS falling edge to CK setup time                               | tDSS                 | 0.2        | -               | 0.2        | -                 | tCK  |      |
| DQS falling edge hold time from CK                              | tDSH                 | 0.2        | -               | 0.2        | -                 | tCK  |      |
| Mode register set command cycle time                            | tMRD                 | 2          | -               | 2          | -                 | tCK  |      |
| Write postamble   | tWPST                | 0.4        | 0.6             | 0.4        | 0.6               | tCK  |      |
| Write preamble  | tWPRE                | 0.35       | -               | 0.35       | -                 | tCK  |      |
| Address and control input setup time                            | tIS                  | 350        | -               | 250        | -                 | ps   |      |
| Address and control input hold time                             | tIH                  | 475        | -               | 375        | -                 | ps   |      |
| Read preamble   | tRPRE                | 0.9        | 1.1             | 0.9        | 1.1               | tCK  |      |
| Read postamble  | tRPST                | 0.4        | 0.6             | 0.4        | 0.6               | tCK  |      |
| Auto-Refresh to Active/Auto-Refresh command period              | tRFC                 | 105        | -               | 105        | -                 | ns   |      |
| Row Active to Row Active Delay for 1KB page size                | tRRD                 | 7.5        | -               | 7.5        | -                 | ns   |      |
| Row Active to Row Active Delay for 2KB page size                | tRRD                 | 10         | -               | 10         | -                 | ns   |      |
| Four Activate Window for 1KB page size                          | tFAW                 | 37.5       | -               | 37.5       | -                 | ns   |      |
| Four Activate Window for 2KB page size                          | tFAW                 | 50         | -               | 50         | -                 | ns   |      |
| CAS to CAS command delay  | tCCD                 | 2          |                 | 2          |                   | tCK  |      |
| Write recovery time   | tWR                  | 15         | -               | 15         | -                 | ns   |      |
| Auto Precharge Write Recovery + Precharge Time                  | tDAL                 | WR+tRP     | -               | tWR+tRP    | -                 | tCK  |      |
| Write to Read Command Delay                                     | tWTR                 | 10         | -               | 7.5        | -                 | ns   |      |
| Internal read to precharge command delay                        | tRTP                 | 7.5        |                 | 7.5        |                   | ns   |      |
| Exit self refresh to a non-read command                         | tXSNR                | tRFC + 10  |                 | tRFC + 10  |                   | ns   |      |
| Exit self refresh to a read command                             | tXSRD                | 200        | -               | 200        | -                 | tCK  |      |
| Exit precharge power down to any non-read command               | tXP                  | 2          | -               | 2          | -                 | tCK  |      |
| Exit active power down to read command                          | tXARD                | 2          |                 | 2          |                   | tCK  |      |
| Exit active power down to read command (Slow exit, Lower power) | tXARDS               | 6 - AL     |                 | 6 - AL     |                   | tCK  |      |
| CKE minimum pulse width (high and low pulse width)              | t <sup>'</sup> CKE   | 3          |                 | 3          |                   | tCK  |      |
| ODT turn-on delay   | t <sup>'</sup> AOND  | 2          | 2               | 2          | 2                 | tCK  |      |
| ODT turn-on   | t <sup>'</sup> AON   | tAC(min)   | tAC(max)+1      | tAC(min)   | tAC(max)+1        | ns   |      |
| ODT turn-on(Power-Down mode)                                    | t <sup>'</sup> AONPD | tAC(min)+2 | 2tCK+tAC(max)+1 | tAC(min)+2 | 2tCK+tAC(max)+1   | ns   |      |
| ODT turn-off delay  | t <sup>'</sup> AOFD  | 2.5        | 2.5             | 2.5        | 2.5               | tCK  |      |
| ODT turn-off  | t <sup>'</sup> AOF   | tAC(min)   | tAC(max)+0.6    | tAC(min)   | tAC(max)+0.6      | ns   |      |
| ODT turn-off (Power-Down mode)                                  | t <sup>'</sup> AOFPD | 2.5        | 2.5             | tAC(min)+2 | 2.5tCK+tAC(max)+1 | ns   |      |

- continued -

| Parameter   | Symbol | DDR2-400   |                         | DDR2-533          |     | Unit | Note |
|---|--------|------------|-------------------------|-------------------|-----|------|------|
|   |        | Min        | Max                     | Min               | Max |      |      |
| ODT to power down entry latency                                   | tANPD  | tAC(min)   | $tAC(max) + 0.6$        | 3                 |     | tCK  |      |
| ODT power down exit latency                                       | tAXPD  | tAC(min)+2 | $2.5tCK + tAC(max) + 1$ | 8                 |     | tCK  |      |
| OCD drive mode output delay                                       | tOIT   | 3          |                         | 0                 | 12  | ns   |      |
| Minimum time clocks remains ON after CKE asynchronously drops LOW | tDelay | 8          |                         | $tIS + tCK + tIH$ |     | ns   |      |
| Average periodic Refresh Interval                                 | tREFI  | -          | 7.8                     | -                 | 7.8 | us   | 2    |
|   | tREFI  | -          | 3.9                     | -                 | 3.9 | us   | 3    |

**Note :**

1. For details and notes, please refer to the relevant HYNIX component datasheet (HY5PS12[8,16]21BFP).
2.  $0^{\circ}\text{C} \leq \text{TCASE} \leq 85^{\circ}\text{C}$
3.  $85^{\circ}\text{C} < \text{TCASE} \leq 95^{\circ}\text{C}$

| Parameter  | Symbol   | DDR2-667      |         | DDR2-800      |         | Unit | Note |
|--|----------|---------------|---------|---------------|---------|------|------|
|  |          | min           | max     | min           | max     |      |      |
| DQ output access time from CK/ $\overline{\text{CK}}$        | tAC      | -450          | +450    | -400          | +400    | ps   |      |
| DQS output access time from CK/ $\overline{\text{CK}}$       | tDQSCK   | -400          | +400    | -350          | +350    | ps   |      |
| CK high-level width  | tCH      | 0.45          | 0.55    | 0.45          | 0.55    | tCK  |      |
| CK low-level width   | tCL      | 0.45          | 0.55    | 0.45          | 0.55    | tCK  |      |
| CK half period   | tHP      | min(tCL, tCH) | -       | min(tCL, tCH) | -       | ps   |      |
| Clock cycle time, CL=x                                       | tCK      | 3000          | 8000    | 2500          |         | ps   |      |
| DQ and DM input setup time (differential strobe)             | tDS      | 100           | -       | 50            | -       | ps   | 1    |
| DQ and DM input hold time (differential strobe)              | tDH      | 175           | -       | 125           | -       | ps   | 1    |
| Control & Address input pulse width for each input           | tIPW     | 0.6           | -       | 0.6           | -       | tCK  |      |
| DQ and DM input pulse width for each input                   | tDIPW    | 0.35          | -       | 0.35          | -       | tCK  |      |
| Data-out high-impedance time from CK/ $\overline{\text{CK}}$ | tHZ      | -             | tAC max | -             | tAC max | ps   |      |
| DQS low-impedance time from CK/ $\overline{\text{CK}}$       | tLZ(DQS) | tAC min       | tAC max | tAC min       | tAC max | ps   |      |
| DQ low-impedance time from CK/ $\overline{\text{CK}}$        | tLZ(DQ)  | 2*tAC min     | tAC max | 2*tAC min     | tAC max | ps   |      |
| DQS-DQ skew for DQS and associated DQ signals                | tDQSQ    | -             | 240     | -             | 200     | ps   |      |
| DQ hold skew factor  | tQHS     | -             | 340     | -             | 300     | ps   |      |
| DQ/DQS output hold time from DQS                             | tQH      | tHP - tQHS    | -       | tHP - tQHS    | -       | ps   |      |
| First DQS latching transition to associated clock edge       | tDQSS    | - 0.25        | + 0.25  | - 0.25        | + 0.25  | tCK  |      |
| DQS input high pulse width                                   | tDQSH    | 0.35          | -       | 0.35          | -       | tCK  |      |
| DQS input low pulse width                                    | tDQSL    | 0.35          | -       | 0.35          | -       | tCK  |      |
| DQS falling edge to CK setup time                            | tDSS     | 0.2           | -       | 0.2           | -       | tCK  |      |
| DQS falling edge hold time from CK                           | tDSH     | 0.2           | -       | 0.2           | -       | tCK  |      |
| Mode register set command cycle time                         | tMRD     | 2             | -       | 2             | -       | tCK  |      |
| Write postamble  | tWPST    | 0.4           | 0.6     | 0.4           | 0.6     | tCK  |      |
| Write preamble   | tWPRE    | 0.35          | -       | 0.35          | -       | tCK  |      |
| Address and control input setup time                         | tIS      | 200           | -       | 175           | -       | ps   |      |
| Address and control input hold time                          | tIH      | 275           | -       | 250           | -       | ps   |      |
| Read preamble  | tRPRE    | 0.9           | 1.1     | 0.9           | 1.1     | tCK  |      |
| Read postamble   | tRPST    | 0.4           | 0.6     | 0.4           | 0.6     | tCK  |      |
| Activate to precharge command                                | tRAS     | 45            | 70000   | 45            | 70000   | ns   |      |
| Active to active command period for 1KB page size products   | tRRD     | 7.5           | -       | 7.5           | -       | ns   |      |
| Active to active command period for 2KB page size products   | tRRD     | 10            | -       | 10            | -       | ns   |      |
| Four Active Window for 1KB page size products                | tFAW     | 37.5          | -       | 35            | -       | ns   |      |
| Four Active Window for 2KB page size products                | tFAW     | 50            | -       | 45            | -       | ns   |      |

- continued -

| Parameter   | Symbol             | DDR2-667     |                       | DDR2-800     |                       | Unit | Note |
|---|--------------------|--------------|-----------------------|--------------|-----------------------|------|------|
|   |                    | min          | max                   | min          | max                   |      |      |
| CAS to $\overline{\text{CAS}}$ command delay                      | tCCD               | 2            |                       | 2            |                       | tCK  |      |
| Write recovery time   | tWR                | 15           | -                     | 15           | -                     | ns   |      |
| Auto precharge write recovery + precharge time                    | tDAL               | WR+tRP       | -                     | WR+tRP       | -                     | tCK  |      |
| Internal write to read command delay                              | tWTR               | 7.5          | -                     | 7.5          | -                     | ns   |      |
| Internal read to precharge command delay                          | tRTP               | 7.5          |                       | 7.5          |                       | ns   |      |
| Exit self refresh to a non-read command                           | tXSNR              | tRFC + 10    |                       | tRFC + 10    |                       | ns   |      |
| Exit self refresh to a read command                               | tXSRD              | 200          | -                     | 200          | -                     | tCK  |      |
| Exit precharge power down to any non-read command                 | tXP                | 2            | -                     | 2            | -                     | tCK  |      |
| Exit active power down to read command                            | tXARD              | 2            |                       | 2            |                       | tCK  |      |
| Exit active power down to read command (Slow exit, Lower power)   | tXARDS             | 7 - AL       |                       | 8 - AL       |                       | tCK  |      |
| CKE minimum pulse width (high and low pulse width)                | t <sub>CKE</sub>   | 3            |                       | 3            |                       | tCK  |      |
| ODT turn-on delay   | t <sub>AOND</sub>  | 2            | 2                     | 2            | 2                     | tCK  |      |
| ODT turn-on   | t <sub>AON</sub>   | tAC(min)     | tAC(max) + 0.7        | tAC(min)     | tAC(max) + 0.7        | ns   |      |
| ODT turn-on(Power-Down mode)                                      | t <sub>AONPD</sub> | tAC(min) + 2 | 2tCK + tAC(max) + 1   | tAC(min) + 2 | 2tCK + tAC(max) + 1   | ns   |      |
| ODT turn-off delay  | t <sub>AOFD</sub>  | 2.5          | 2.5                   | 2.5          | 2.5                   | tCK  |      |
| ODT turn-off  | t <sub>AOF</sub>   | tAC(min)     | tAC(max) + 0.6        | tAC(min)     | tAC(max) + 0.6        | ns   |      |
| ODT turn-off (Power-Down mode)                                    | t <sub>AOFPD</sub> | tAC(min) + 2 | 2.5tCK + tAC(max) + 1 | tAC(min) + 2 | 2.5tCK + tAC(max) + 1 | ns   |      |
| ODT to power down entry latency                                   | tANPD              | 3            |                       | 3            |                       | tCK  |      |
| ODT power down exit latency                                       | tAXPD              | 8            |                       | 8            |                       | tCK  |      |
| OCD drive mode output delay                                       | tOIT               | 0            | 12                    | 0            | 12                    | ns   |      |
| Minimum time clocks remains ON after CKE asynchronously drops LOW | tDelay             | tIS+tCK+tIH  |                       | tIS+tCK+tIH  |                       | ns   |      |
| Average periodic Refresh Interval                                 | tREFI              | -            | 7.8                   | -            | 7.8                   | us   | 2    |
|   | tREFI              | -            | 3.9                   | -            | 3.9                   | us   | 3    |

**Note :**

1. For details and notes, please refer to the relevant HYNIX component datasheet (HY5PS12[8,16]21BFP).
2. 0°C ≤ TCASE ≤ 85°C
3. 85°C < TCASE ≤ 95°C



**PACKAGE OUTLINE**  
**32Mx64 - HYMP532U64BP6**

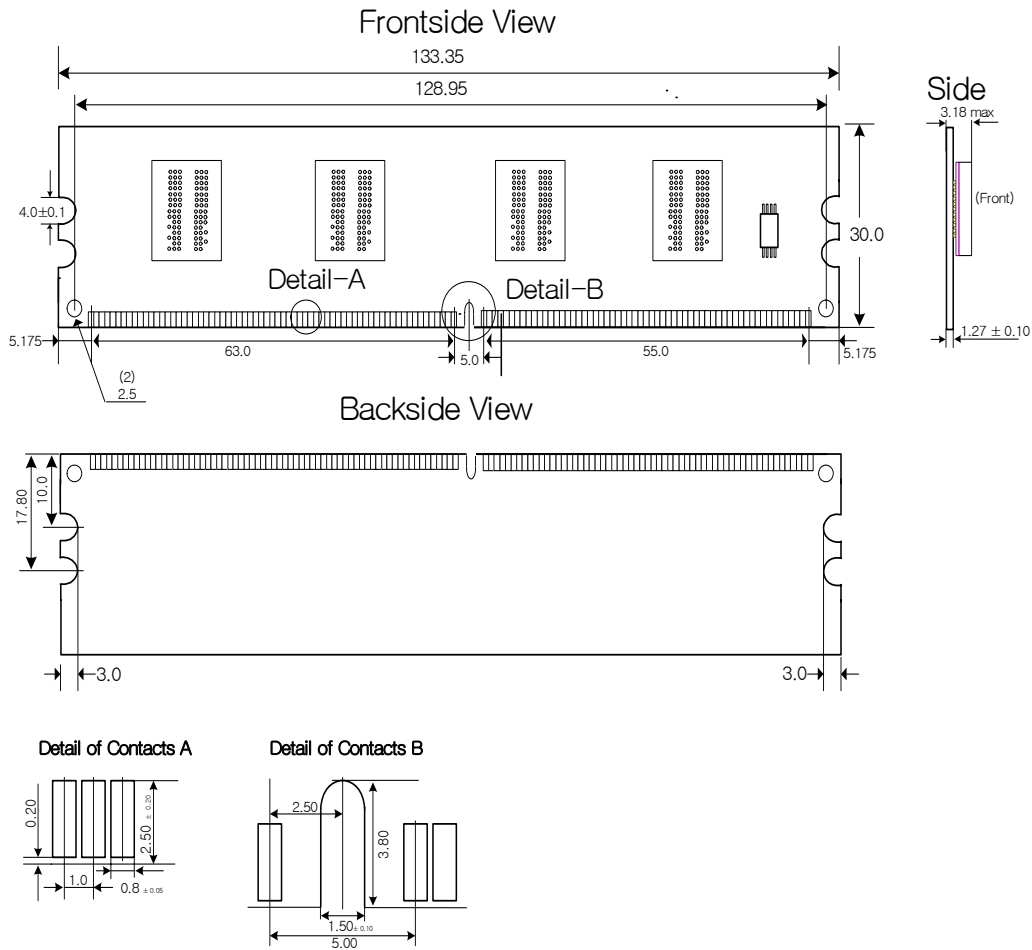

Note) All dimensions are in millimeters unless otherwise stated.

**PACKAGE OUTLINE**  
**64Mx 64 - HYMP564U64BP8**

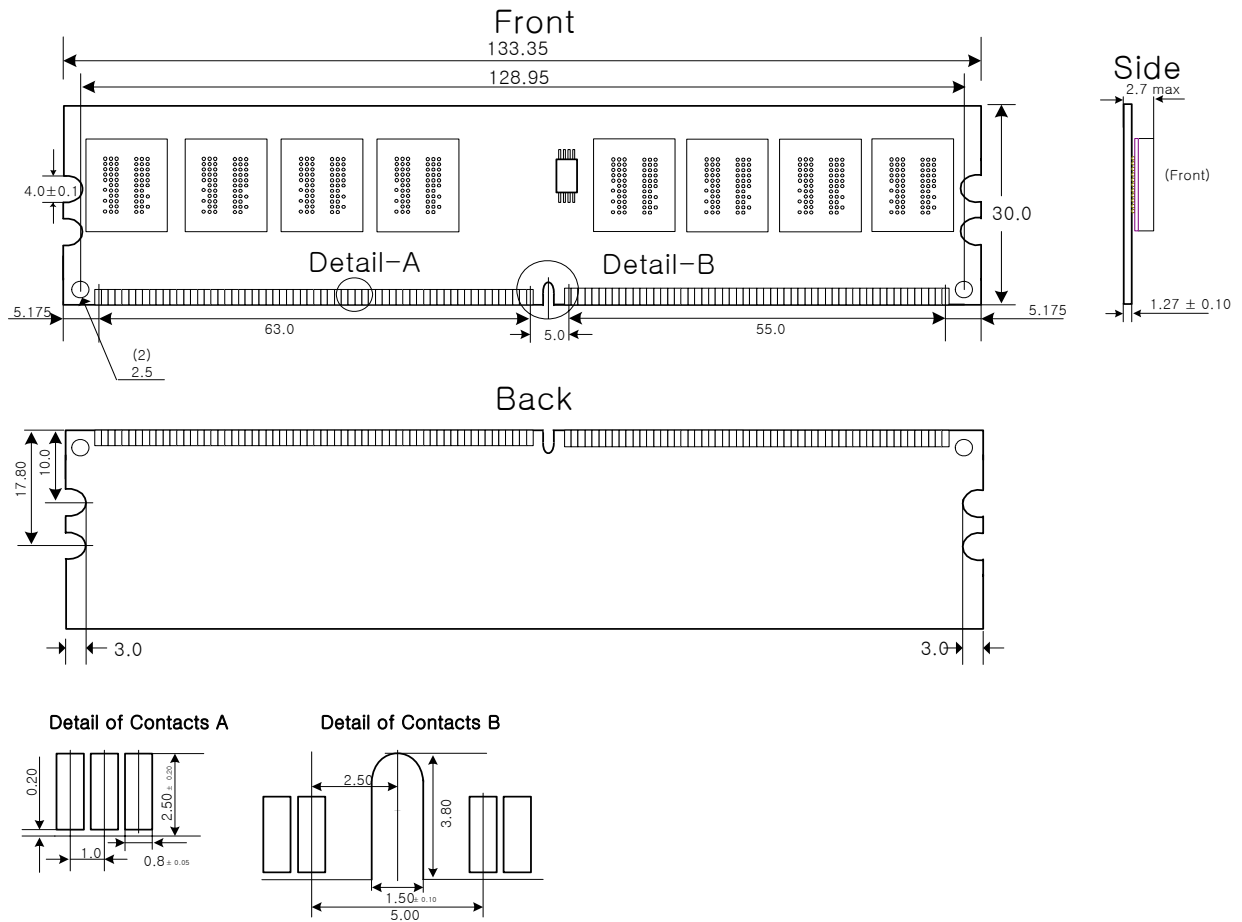

Note) All dimensions are in millimeters unless otherwise stated.

**PACKAGE OUTLINE**  
**64Mx 72 - HYMP564U72BP8**

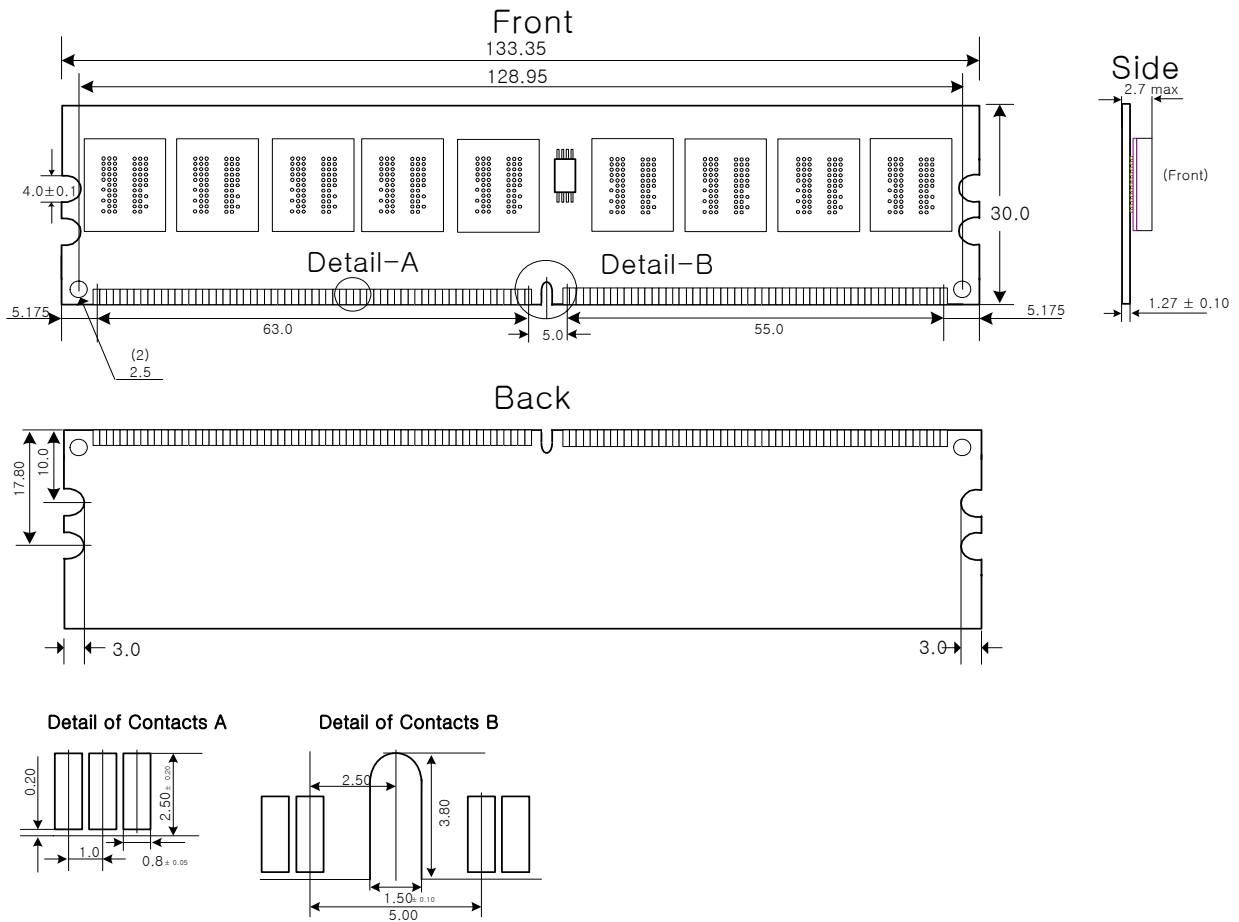

Note) All dimensions are in millimeters unless otherwise stated.

**PACKAGE OUTLINE**  
**128Mx 64 - HYMP512U64BP8**

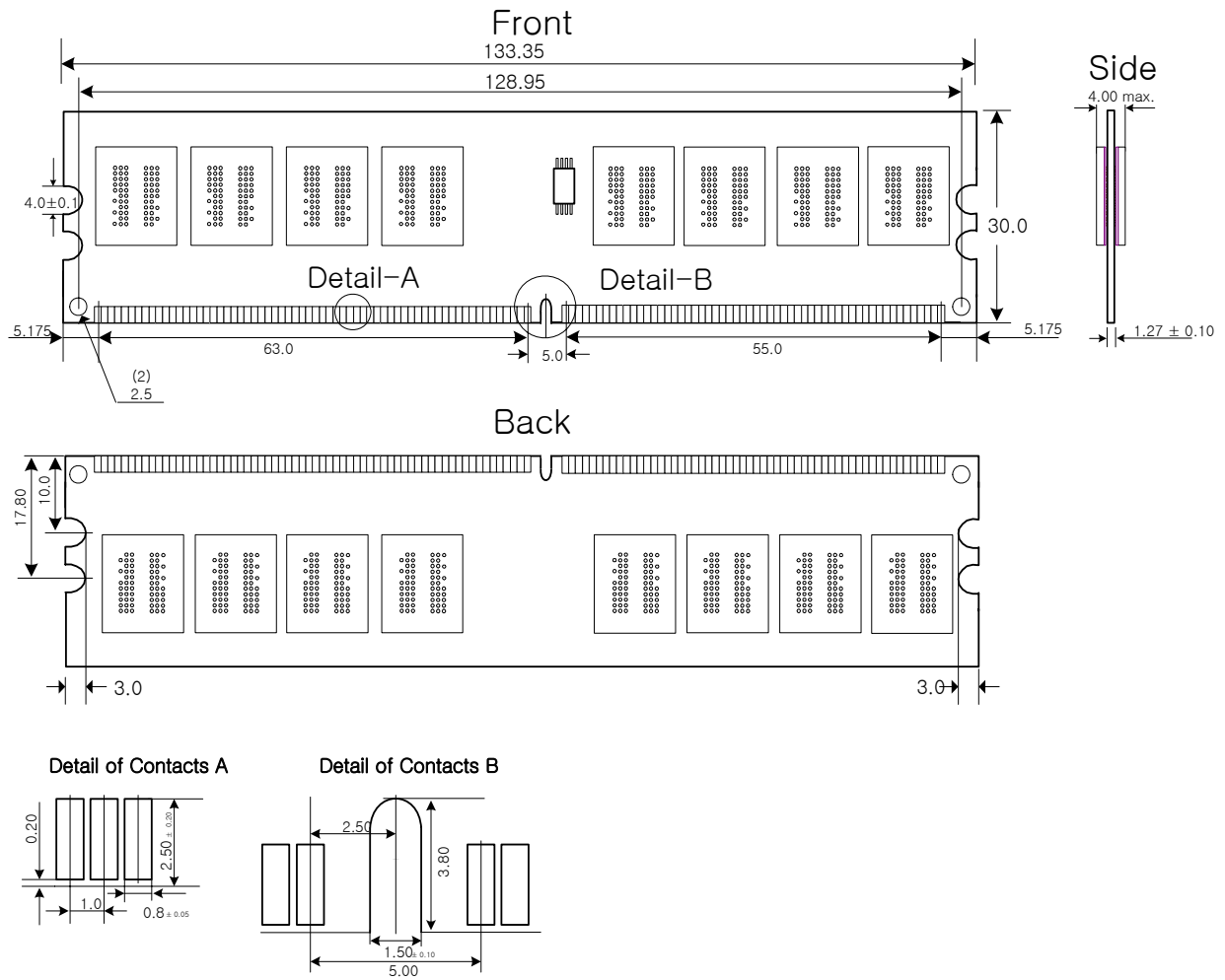

Note) All dimensions are in millimeters unless otherwise stated.



**REVISION HISTORY**

| Revision | History  | Date      | Remark |
|----------|--|-----------|--------|
| 0.1      | First Version Release                                      | June 2005 |        |
| 0.2      | Leakage current spec. added to the DC OPERATING CONDITIONS | July 2006 |        |
| 0.3      | Added IDD Spec for S6(800Mhz part)                         | Aug. 2006 |        |
| 0.4      | Updated IDD All Values                                     | Aug. 2006 |        |
| 0.5      | Added Guide holes to DIMM Outline                          | Dec. 2006 |        |
| 0.6      | Updated SPEED GRADE & KEY PARAMETERS on page 2             | Feb. 2007 |        |