

FEATURES

- Low $R_{DS(on)}$ of 12 m Ω
- Low input voltage range: 1.8 V to 5.5 V
- 3 A continuous operating current at 70°C
- 1.2 V logic compatible enable input
- Low 18 μ A quiescent current, $V_{IN} < 3$ V
- Low 30 μ A quiescent current, $V_{IN} = 5$ V
- Overtemperature protection
- Ultralow shutdown current: <1 μ A
- Ultrasmall 1.0 mm \times 1.5 mm, 6-ball, 0.5 mm pitch WLCSP

APPLICATIONS

- Mobile phones
- Digital cameras and audio devices
- Portable and battery-powered equipment

GENERAL DESCRIPTION

The ADP197 is a high-side load switch designed for operation between 1.8 V and 5.5 V. This load switch provides power domain isolation, helping extended power domain isolation. The device contains a low on-resistance, N-channel MOSFET that supports more than 3 A of continuous current and minimizes power loss. The low 18 μ A quiescent current and ultralow shutdown current make the ADP197 ideal for battery-operated portable equipment. The built-in level shifter for enable logic makes the ADP197 compatible with many processors and GPIO controllers.

TYPICAL APPLICATIONS CIRCUIT

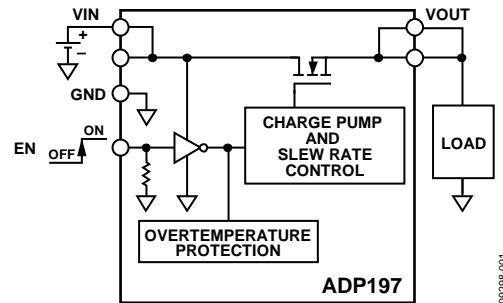

Figure 1.

Overtemperature protection circuitry activates if the junction temperature exceeds 125°C, thereby protecting itself and downstream circuits from potential damage.

In addition to operating performance, the ADP197 occupies minimal printed circuit board (PCB) space with an area of less than 1.5 mm² and a height of 0.60 mm.

The ADP197 is available in an ultrasmall, 1 mm \times 1.5 mm, 6-ball, 0.5 mm pitch WLCSP.

Rev. 0

Information furnished by Analog Devices is believed to be accurate and reliable. However, no responsibility is assumed by Analog Devices for its use, nor for any infringements of patents or other rights of third parties that may result from its use. Specifications subject to change without notice. No license is granted by implication or otherwise under any patent or patent rights of Analog Devices. Trademarks and registered trademarks are the property of their respective owners.

TABLE OF CONTENTS

Features	1	Typical Performance Characteristics	6
Applications.....	1	Theory of Operation	10
Typical Applications Circuit.....	1	Applications Information	11
General Description	1	Capacitor Selection	11
Revision History	2	Ground Current.....	11
Specifications.....	3	Enable Feature	11
Timing Diagram	3	Timing	11
Absolute Maximum Ratings.....	4	Outline Dimensions	13
ESD Caution.....	4	Ordering Guide	13
Pin Configuration and Function Descriptions.....	5		

REVISION HISTORY

3/11—Revision 0: Initial Version

SPECIFICATIONS

$V_{IN} = 1.8\text{ V}$, $V_{EN} = V_{IN}$, $I_{OUT} = 1\text{ A}$, $T_A = 25^\circ\text{C}$, unless otherwise noted.

Table 1.

Parameter	Symbol	Test Conditions/Comments	Min	Typ	Max	Unit
INPUT VOLTAGE RANGE	V_{IN}	$T_J = -40^\circ\text{C}$ to $+85^\circ\text{C}$	1.8		5.5	V
EN INPUT						
EN Input	V_{IH}	$V_{IN} = 1.8\text{ V}$ to 5.5 V	1.2			V
	V_{IL}	$V_{IN} = 1.8\text{ V}$ to 5.5 V			0.4	V
EN Input Pull-Down Current	I_{EN}	$V_{IN} = 1.8\text{ V}$		500		nA
CURRENT						
Ground Current	I_{GND}	$V_{IN} = 1.8\text{ V}$		18		μA
		$V_{IN} = 3.4\text{ V}$		14		μA
		$V_{IN} = 4.2\text{ V}$, $T_J = -40^\circ\text{C}$ to $+85^\circ\text{C}$		18	30	μA
		$V_{IN} = 5.5\text{ V}$		28		μA
Off State Current	I_{OFF}	$V_{EN} = \text{GND}$, $V_{OUT} = 0\text{ V}$, $V_{IN} = 4.2\text{ V}$		0.1		μA
		$V_{EN} = \text{GND}$, $T_J = -40^\circ\text{C}$ to $+85^\circ\text{C}$, $V_{OUT} = 0\text{ V}$, $V_{IN} = 1.8\text{ V}$ to 5.5 V			20	μA
Continuous Operating Current ¹	I_{OUT}	$V_{IN} = 1.8\text{ V}$ to 5.5 V		3		A
VIN TO VOUT RESISTANCE	$R_{DS(ON)}$					
		$V_{IN} = 5.5\text{ V}$		0.012		Ω
		$V_{IN} = 4.2\text{ V}$		0.012		Ω
		$V_{IN} = 1.8\text{ V}$		0.012		Ω
		$V_{IN} = 1.8\text{ V}$, $T_J = -40^\circ\text{C}$ to $+85^\circ\text{C}$		0.012	0.017	Ω
VOUT TURN-ON DELAY TIME		See Figure 2				
Turn-On Delay Time	t_{ON_DLY}	$V_{IN} = 1.8\text{ V}$ to 5.5 V , $C_{LOAD} = 1\text{ }\mu\text{F}$		1		ms
THERMAL SHUTDOWN						
Thermal Shutdown Threshold	T_{SD}	T_J rising		125		$^\circ\text{C}$
Thermal Shutdown Hysteresis	T_{SD-HYS}			15		$^\circ\text{C}$

¹ At an ambient temperature of 85°C , the part can withstand a continuous current of 2.22 A. At a load current of 3 A, the operational lifetime derates to 2190 hours.

TIMING DIAGRAM

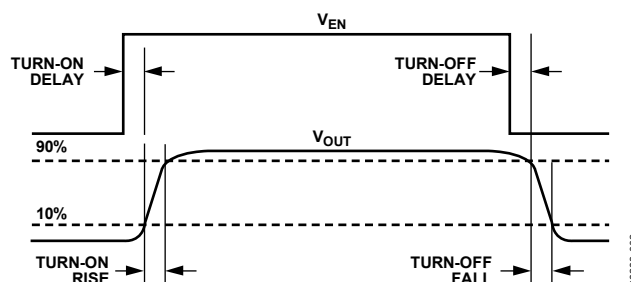

Figure 2. Timing Diagram

ABSOLUTE MAXIMUM RATINGS

Table 2.

Parameter	Rating
V _{IN} to GND	−0.3 V to +6.5 V
V _{OUT} to GND	−0.3 V to V _{IN}
EN to GND	−0.3 V to V _{IN}
Continuous Drain Current	
T _A = 25°C	±4 A
T _A = 85°C	±2.22 A
Continuous Diode Current	−50 mA
Storage Temperature Range	−65°C to +150°C
Operating Junction Temperature Range	−40°C to +105°C
Soldering Conditions	JEDEC J-STD-020

Stresses above those listed under Absolute Maximum Ratings may cause permanent damage to the device. This is a stress rating only; functional operation of the device at these or any other conditions above those indicated in the operational section of this specification is not implied. Exposure to absolute maximum rating conditions for extended periods may affect device reliability.

Table 3. Typical θ_{JA} and Ψ_{JB} Values

Package Type	θ_{JA}	Ψ_{JB}	Unit
6-Ball, 0.5 mm Pitch WLCSP	260	58	°C/W

ESD CAUTION



ESD (electrostatic discharge) sensitive device.

Charged devices and circuit boards can discharge without detection. Although this product features patented or proprietary protection circuitry, damage may occur on devices subjected to high energy ESD. Therefore, proper ESD precautions should be taken to avoid performance degradation or loss of functionality.

PIN CONFIGURATION AND FUNCTION DESCRIPTIONS

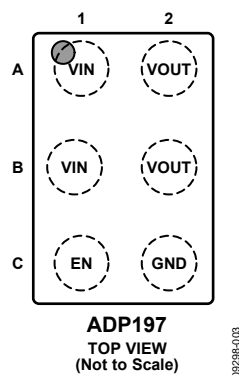

Figure 3. Pin Configuration

Table 4. Pin Function Descriptions

Pin No.	Mnemonic	Description
A1, B1	VIN	Input Voltage.
A2, B2	VOUT	Output Voltage.
C1	EN	Enable Input. Drive EN high to turn on the switch and drive EN low to turn off the switch.
C2	GND	Ground.

TYPICAL PERFORMANCE CHARACTERISTICS

$V_{IN} = 1.8\text{ V}$, $V_{EN} = V_{IN}$, $C_{IN} = C_{OUT} = 1\ \mu\text{F}$, $T_A = 25^\circ\text{C}$, unless otherwise noted.

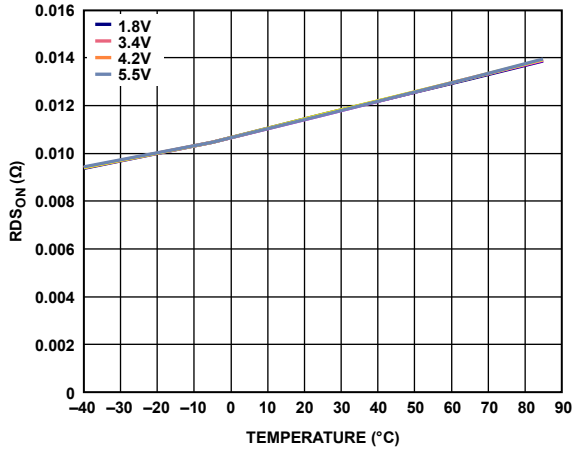

Figure 4. $R_{DS(on)}$ vs. Temperature, 500 mA

09298-004

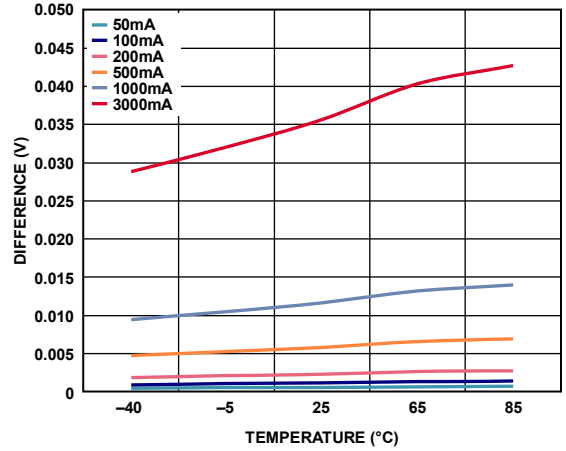

Figure 7. Voltage Drop vs. Temperature, Different Load Currents

09298-007

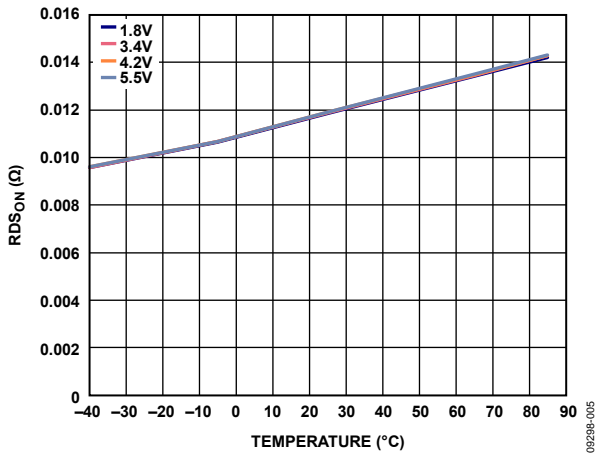

Figure 5. $R_{DS(on)}$ vs. Temperature, 3 A, Different Input Voltages (V_{IN})

09298-005

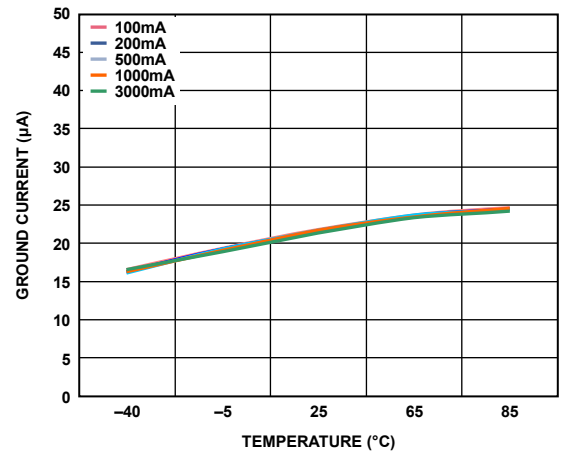

Figure 8. Ground Current vs. Temperature, Different Load Currents, $V_{IN} = 1.8\text{ V}$

09298-016

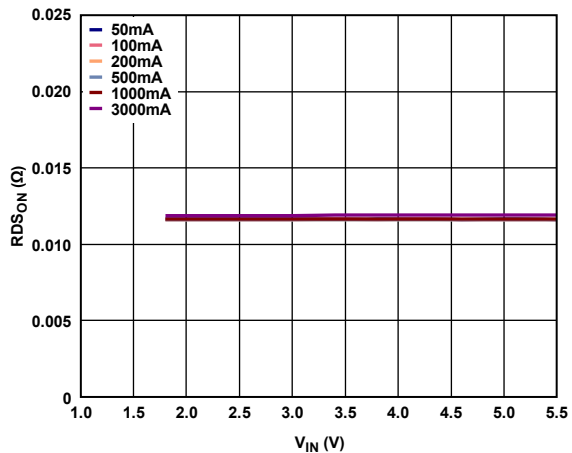

Figure 6. $R_{DS(on)}$ vs. Input Voltage (V_{IN}), Different Load Currents

09298-006

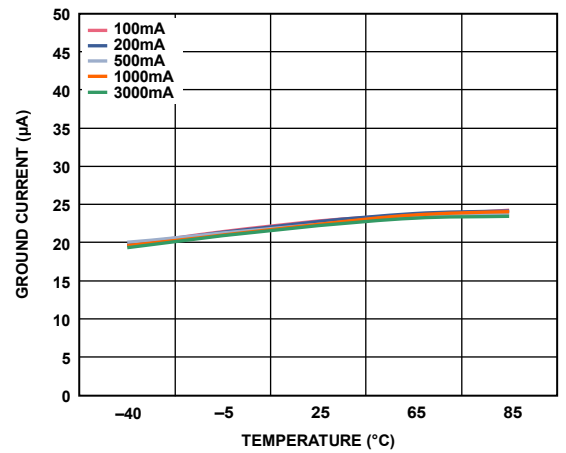

Figure 9. Ground Current vs. Temperature, Different Load Currents, $V_{IN} = 4.2\text{ V}$

09298-017

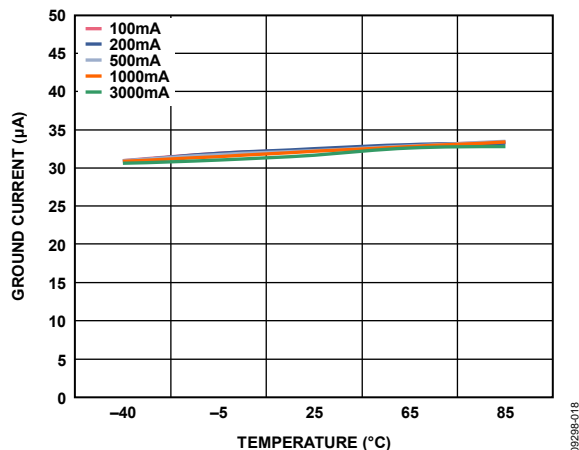

Figure 10. Ground Current vs. Temperature, Different Load Currents, $V_{IN} = 5.5V$

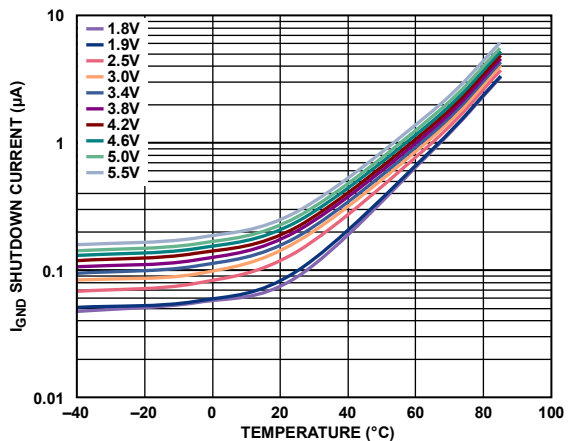

Figure 13. Ground Shutdown Current vs. Temperature, $V_{OUT} = 0V$, Different Input Voltages (V_{IN})

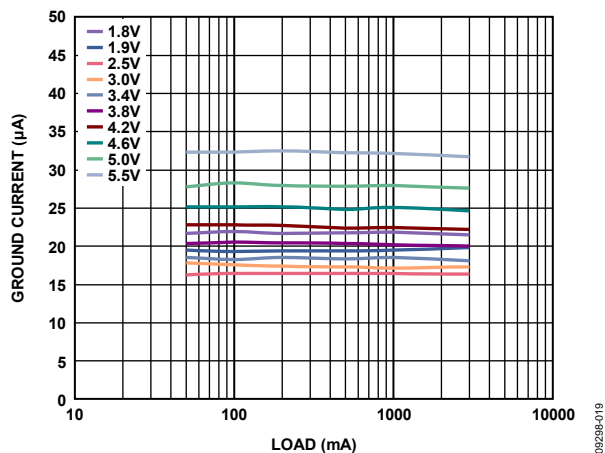

Figure 11. Ground Current vs. Load Current, Different Input Voltages (V_{IN})

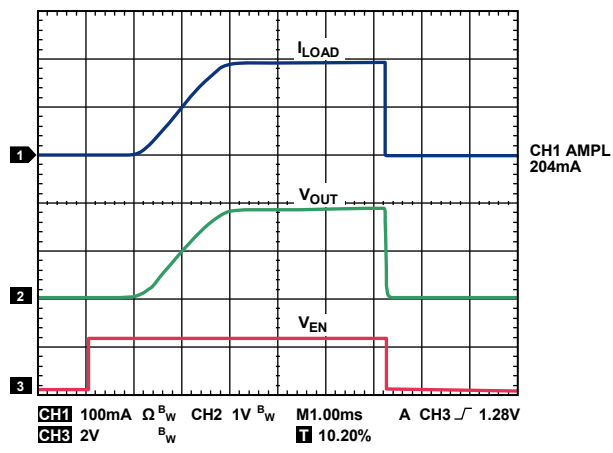

Figure 14. Typical Turn-On Time and Inrush Current, $V_{IN} = 1.9V$, 200 mA Load

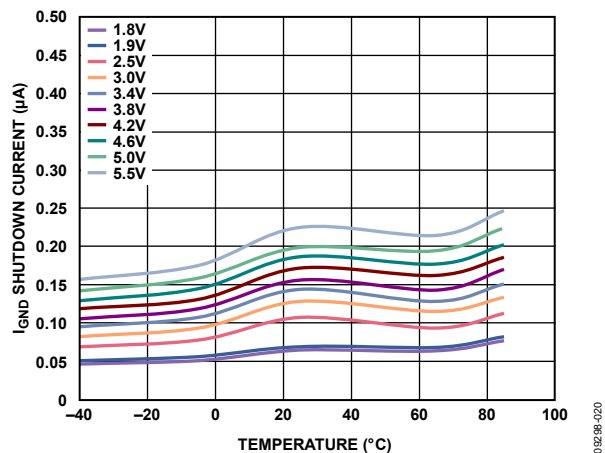

Figure 12. Ground Shutdown Current vs. Temperature, Output Open, Different Input Voltages (V_{IN})

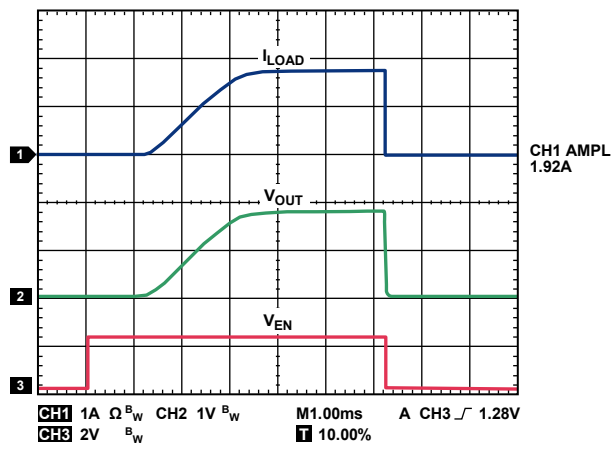

Figure 15. Typical Turn-On Time and Inrush Current, $V_{IN} = 1.9V$, 2 A Load

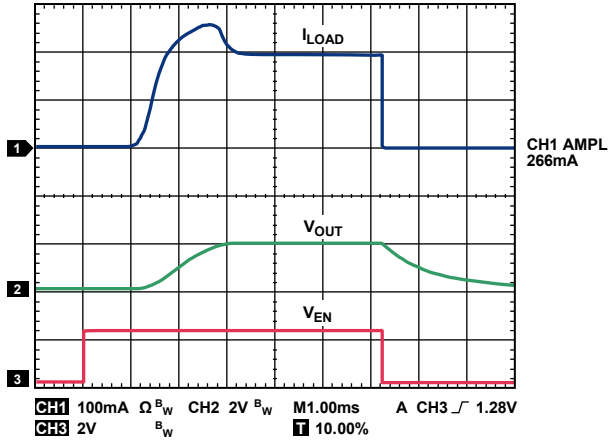

Figure 16. Typical Turn-On Time and Inrush Current, $V_{IN} = 1.9V$, 200 mA Load, $C_{OUT} = 100 \mu F$

09298-010

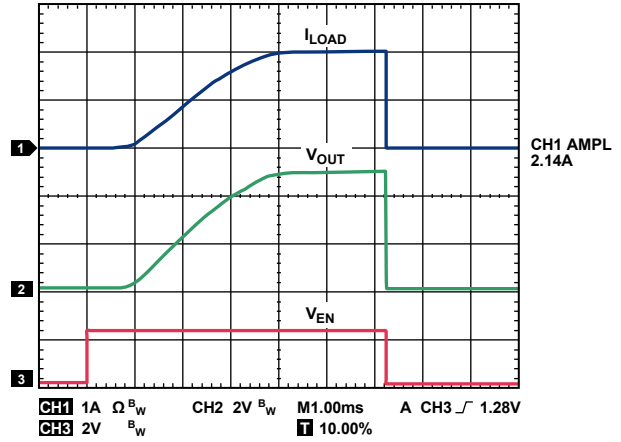

Figure 19. Typical Turn-On Time and Inrush Current, $V_{IN} = 5.5V$, 2 A Load

09298-013

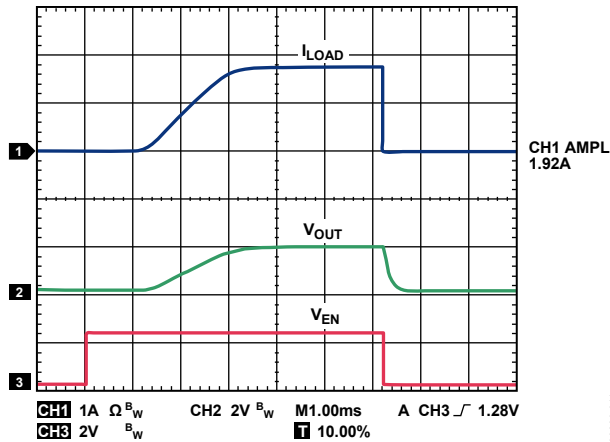

Figure 17. Typical Turn-On Time and Inrush Current, $V_{IN} = 1.9V$, 2 A Load, $C_{OUT} = 100 \mu F$

09298-011

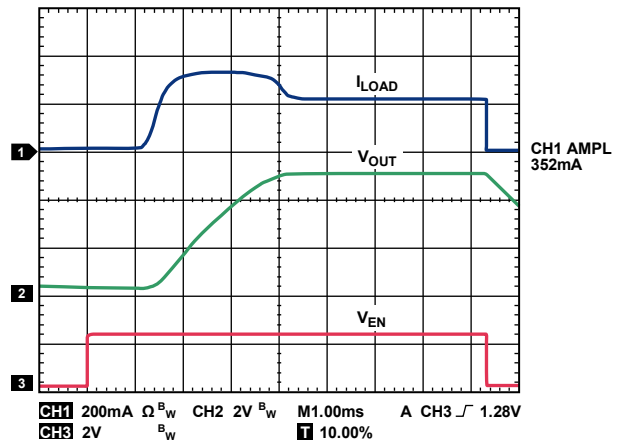

Figure 20. Typical Turn-On Time and Inrush Current, $V_{IN} = 5.5V$, 200 mA Load, $C_{OUT} = 100 \mu F$

09298-014

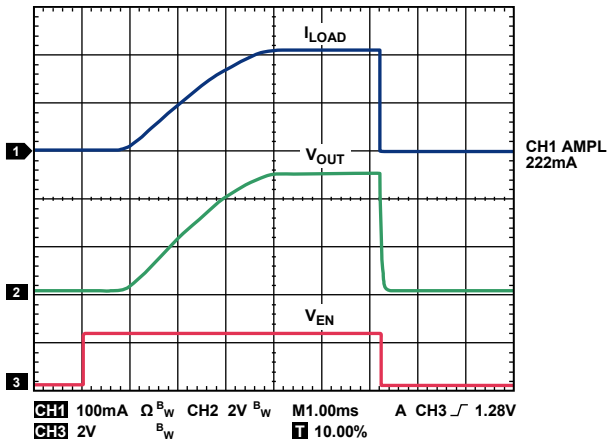

Figure 18. Typical Turn-On Time and Inrush Current, $V_{IN} = 5.5V$, 200 mA Load

09298-012

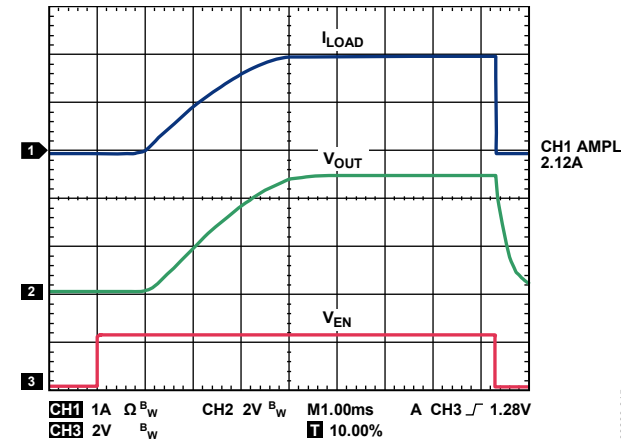

Figure 21. Typical Turn-On Time and Inrush Current, $V_{IN} = 5.5V$, 2 A Load, $C_{OUT} = 100 \mu F$

09298-015

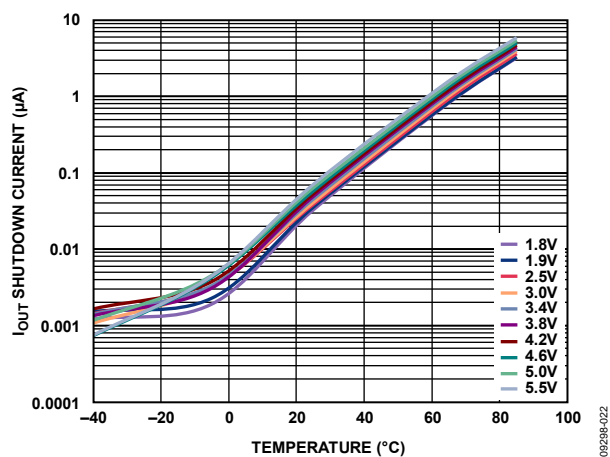

Figure 22. Output Shutdown Current vs. Temperature, $V_{OUT} = 0 V$, Different Input Voltages (V_{IN})

THEORY OF OPERATION

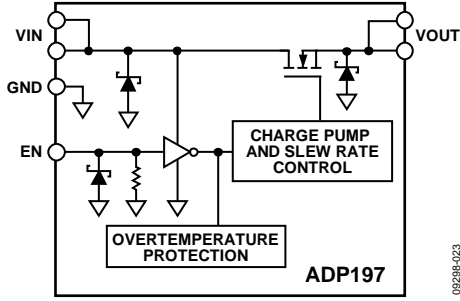

Figure 23. Functional Block Diagram

The ADP197 is a high-side NMOS load switch, controlled by an internal charge pump. The ADP197 is designed to operate with power supply voltages between 1.8 V and 5.5 V.

An internal charge pump biases the NMOS switch to achieve a relatively constant, ultralow on resistance of 12 mΩ across the entire input voltage range. The use of the internal charge pump also allows for controlled turn-on times. Turning the NMOS switch

on and off is controlled by the enable input, EN, which is capable of interfacing directly with 1.8 V logic signals.

The ADP197 is capable of 3 A of continuous current as long as T_j is less than 70°C. At 85°C, the rated current drops to 2.22 A.

The overtemperature protection circuit activates if the load current causes the junction temperature to exceed 125°C. When this occurs, the overtemperature protection circuitry disables the output until the junction temperature falls below approximately 110°C, at which point the output is reenabled. If the fault condition persists, the output cycles off and on until the fault is removed.

ESD protection structures are shown in the block diagram as Zener diodes.

The ADP197 is a low quiescent current device with a nominal 4 MΩ pull-down resistor on its enable pin (EN). The package is a space-saving 1.0 mm × 1.5 mm, 6-ball WLCSP.

APPLICATIONS INFORMATION

CAPACITOR SELECTION

Output Capacitor

The ADP197 is designed for operation with small, space-saving ceramic capacitors but functions with most commonly used capacitors when the effective series resistance (ESR) value is carefully considered. The ESR of the output capacitor affects the response to load transients. A typical 1 μF capacitor with an ESR of 0.1 Ω or less is recommended for good transient response. Using a larger value of output capacitance improves the transient response to large changes in load current.

Input Bypass Capacitor

Connecting at least 1 μF of capacitance from V_{IN} to GND reduces the circuit sensitivity to the printed circuit board (PCB) layout, especially when high source impedance or long input traces are encountered. When greater than 1 μF of output capacitance is required, increase the input capacitor to match it.

GROUND CURRENT

The major source for ground current in the ADP197 is the internal charge pump for the FET drive circuitry. Figure 24 shows the typical ground current when $V_{\text{EN}} = V_{\text{IN}}$, and varies from 1.8 V to 5.5 V.

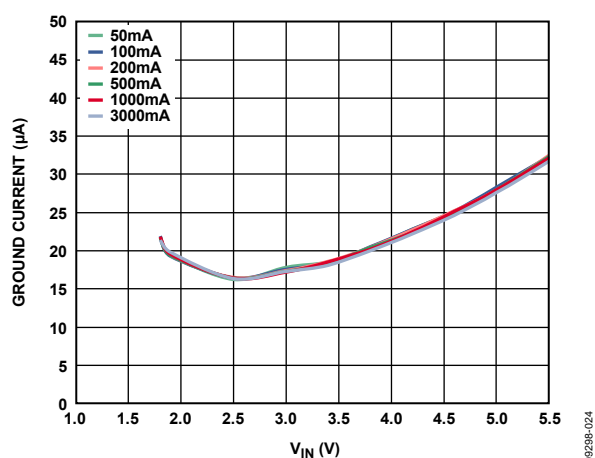

Figure 24. Ground Current vs. Load Current, Different Input Voltages (V_{IN})

ENABLE FEATURE

The ADP197 uses the EN pin to enable and disable the V_{OUT} pin under normal operating conditions. As shown in Figure 25, when a rising voltage (V_{EN}) on the EN pin crosses the active threshold, V_{OUT} turns on. When a falling voltage (V_{EN}) on the EN pin crosses the inactive threshold, V_{OUT} turns off.

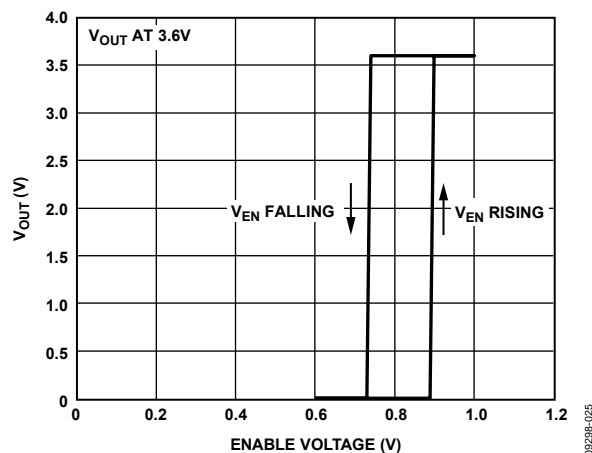

Figure 25. Typical EN Operation

As shown in Figure 25, the EN pin has hysteresis built into it. This prevents on/off oscillations that can occur due to noise on the EN pin as it passes through the threshold points.

The EN pin active/inactive thresholds derive from the V_{IN} voltage; therefore, these thresholds vary with the changing input voltage. Figure 26 shows the typical EN active/inactive thresholds when the input voltage varies from 1.8 V to 5.5 V.

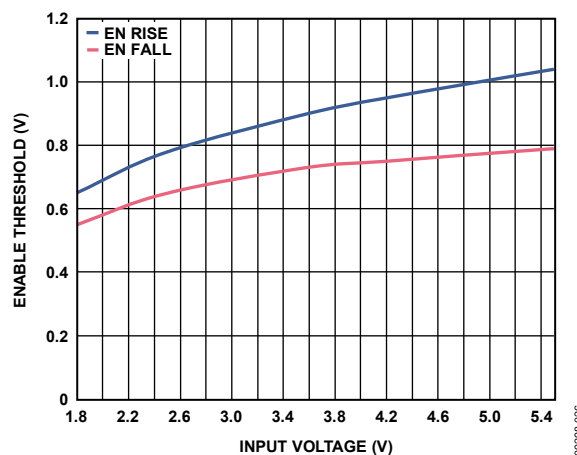

Figure 26. Typical EN Thresholds vs. Input Voltage (V_{IN})

TIMING

Turn-on delay is defined as the interval between the time that V_{EN} exceeds the rising threshold voltage and when V_{OUT} rises to $\sim 10\%$ of its final value. The ADP197 includes circuitry that has a typical 1 ms turn-on delay and a controlled rise time to limit the V_{IN} inrush current. As shown in Figure 27 and Figure 28, the turn-on delay is nearly independent of the input voltage.

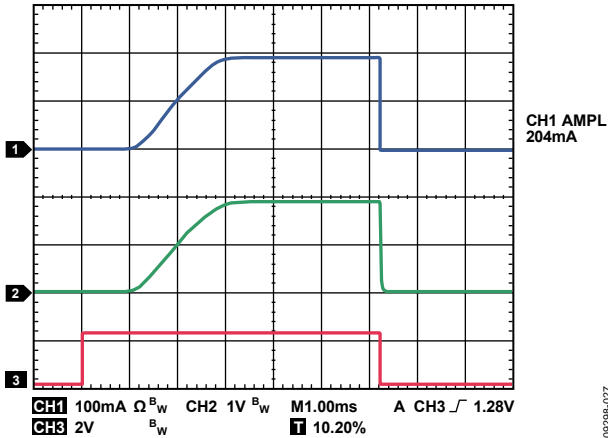

Figure 27. Typical Turn-On Delay Time with $V_{IN} = 1.9V$, $I_{LOAD} = 200mA$

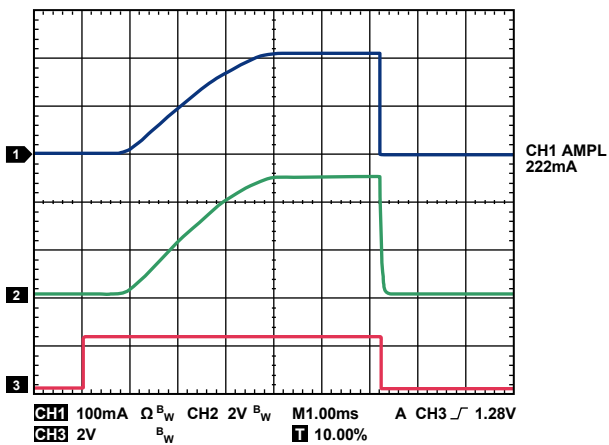

Figure 28. Typical Turn-On Delay Time with $V_{IN} = 5.5V$, $I_{LOAD} = 220mA$

The rise time is defined as the time it takes the output voltage to rise from 10% to 90% of V_{OUT} reaching its final value. It is dependent on the rise time of the internal charge pump.

For very large values of output capacitance, the RC time constant (where C is the load capacitance (C_{LOAD}) and R is the $R_{DS(ON)} || R_{LOAD}$) can become a factor in the rise time of the output voltage. Because $R_{DS(ON)}$ is much smaller than R_{LOAD} , an adequate approximation for RC is $R_{DS(ON)} \times C_{LOAD}$. An input or load capacitor is not required for the ADP197 although capacitors can be used to suppress noise on the board.

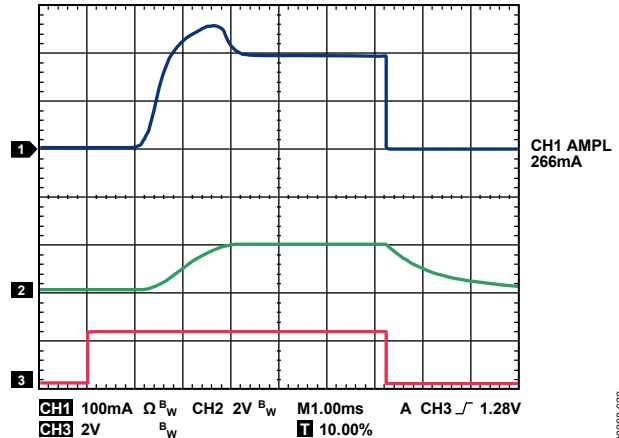

Figure 29. Typical Rise Time and Inrush Current, $C_{LOAD} = 100\mu F$, $V_{IN} = 1.9V$, $I_{LOAD} = 270mA$

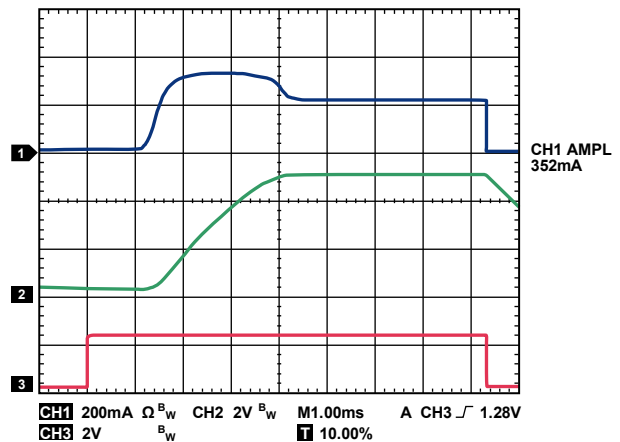

Figure 30. Typical Rise Time and Inrush Current, $C_{LOAD} = 100\mu F$, $V_{IN} = 5.5V$, $I_{LOAD} = 350mA$

The turn-off time is defined as the time it takes for the output voltage to fall from 90% to 10% of V_{OUT} reaching its final value. It is also dependent on the RC time constant of the output capacitance and load resistance. Figure 31 shows the typical turn-off time with $V_{IN} = 3.6V$, $C_{OUT} = 1\mu F$, and $R_{LOAD} = 18\Omega$.

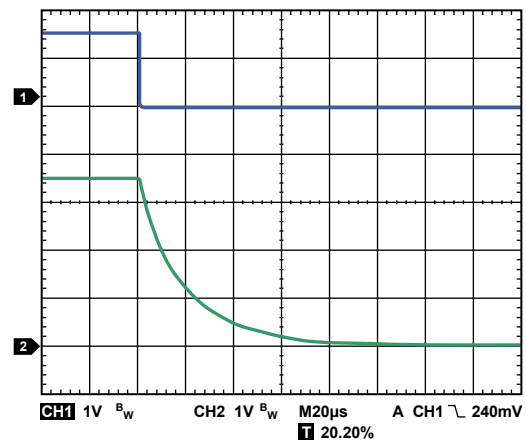
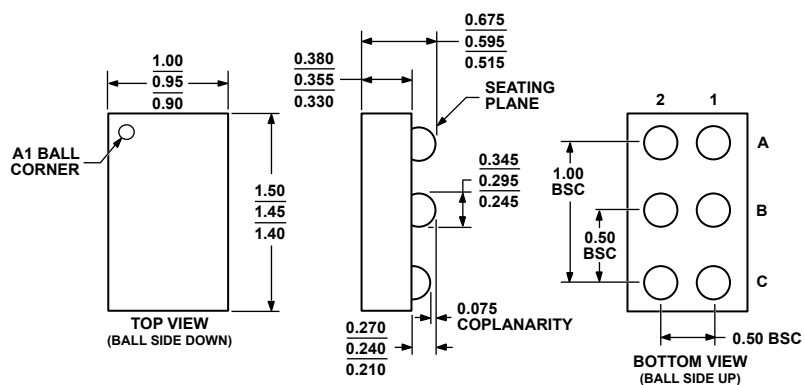

Figure 31. Typical Turn-Off Time

OUTLINE DIMENSIONS



0816807-B

Figure 32. 6-Ball Wafer Level Chip Scale Package [WLCSP]
(CB-6-2)
Dimensions shown in millimeters

ORDERING GUIDE

Model ¹	Temperature Range	Package Description	Package Option	Branding
ADP197ACBZ-R7	-40°C to +85°C	6-Ball Wafer Level Chip Scale Package [WLCSP]	CB-6-2	87
ADP197CB-EVALZ		Evaluation Board		

¹ Z = RoHS Compliant Part.

ADP197

NOTES

NOTES

ADP197

NOTES