

VI TELEFILTER**Resonator specification****TFR 315B****1/5****Measurement condition**

Ambient temperature:	25	°C
Input power level:	0	dBm
Terminating impedance: *		
Input:	50	Ω
Output:	50	Ω

Characteristics

Remark:

The minimum of the pass band attenuation a_{\min} is defined as the insertion loss a_e . The centre frequency f_C is the frequency of the minimum of the passband attenuation a_{\min} . The tolerance for the centre frequency also includes a frequency shift due to the temperature coefficient of frequency TC_f in the operating temperature range and a production tolerance for the centre frequency f_C .

D a t a		typ. value	tolerance / limit
Insertion loss (reference level)	$a_e = a_{\min}$	-	max. 2,5 dB
Centre frequency	f_C	315,15 MHz	±100 kHz
Ageing of centre frequency (Absolute value during the first year)		-	max. -40/+10 ppm/yr
Quality factor	Unloaded Q	8400	-
	Loaded Q 50Ω	2000	-
Parallel capacitance	C_0	3,8 pF	-
Motional resistance	R_1	27 Ω	-
Motional inductance	L_1	117 μH	-
Motional capacitance	C_1	2,1 fF	-
DC insulation resistance		-	min. 1 MΩ
Permissible DC voltage	V_{DC}	-	max. 12 V
Input power level		-	max. 0 dBm
Operating temperature range	OTR	-	-10 °C ... + 60°C
Storage temperature range		-	-40 °C ... + 85°C
Turnover temperature	T_0	25 °C	max. ± 15 °C
Temperature coefficient of frequency	TC_f **	0,035 ppm/K ²	

*) The equivalent circuit model is for reference only.

***) $\Delta f(\text{Hz}) = TC_f(\text{ppm/K}^2) \times (T_0 - T)^2 \times f_{CAT}(\text{MHz})$.

Generated:**Checked / Approved:**

Tele Filter GmbH
Potsdamer Straße 18
D 14 513 TELTOW / Germany
Tel: (+49) 3328 4784-0 / Fax: (+49) 3328 4784-30
E-Mail: tft@telefilter.com

VI TELEFILTER reserves the right to make changes to the product(s) and/or information contained herein without notice. No liability is assumed as a result of their use or application. No rights under any patent accompany the sale of any such product(s) or information.

Resonator characteristic

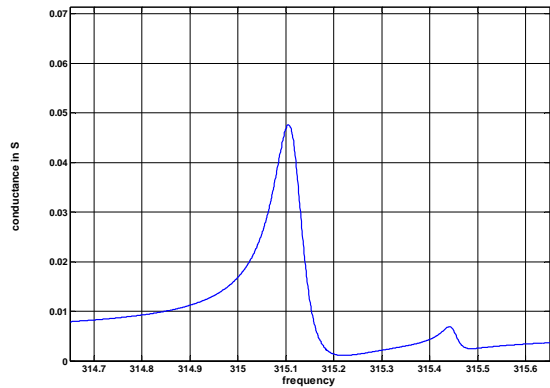
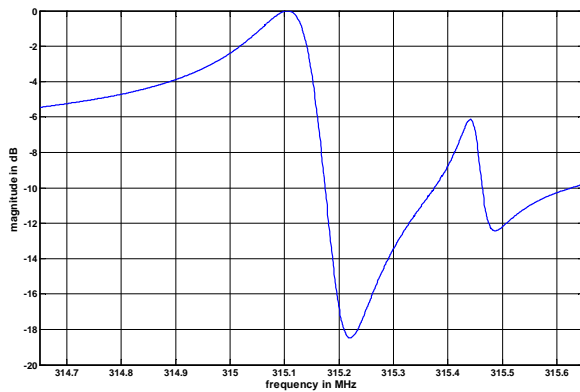

Construction and pin connection

(All dimensions in mm)

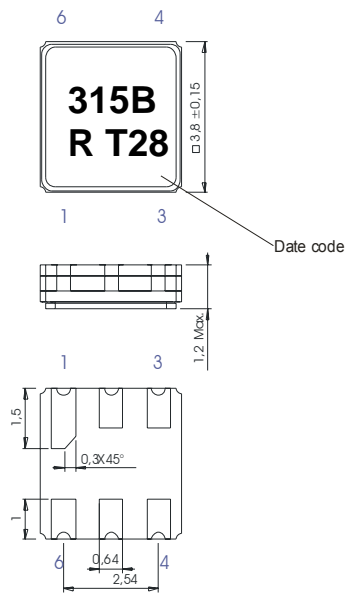

- 1 Ground
- 2 Input
- 3 Ground
- 4 Ground
- 5 Output
- 6 Ground

Date code: Year + week
 T 2005
 U 2006
 V 2007
 ...

50 Ohm Test circuit

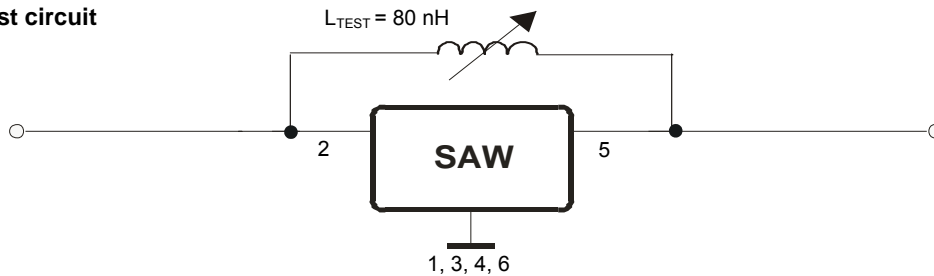

Equivalent Circuit

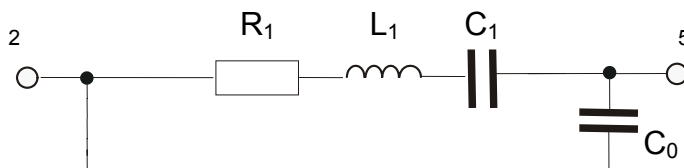

Tele Filter GmbH
 Potsdamer Straße 18
 D 14 513 TELTOW / Germany
 Tel: (+49) 3328 4784-0 / Fax: (+49) 3328 4784-30
 E-Mail: tft@telefilter.com

VI TELEFILTER reserves the right to make changes to the product(s) and/or information contained herein without notice. No liability is assumed as a result of their use or application. No rights under any patent accompany the sale of any such product(s) or information.

Stability characteristics

After the following tests the filter shall meet the whole specification:

- 1. Shock: 500g, 1 ms, half sine wave, 3 shocks each plane;
DIN IEC 68 T2 - 27
- 2. Vibration: 10 Hz to 500 Hz, 0,35 mm or 5 g respectively, 1 octave per min, 10 cycles per plan, 3 plans;
DIN IEC 68 T2 - 6
- 3. Change of temperature: -55 °C to 125°C / 30 min. each / 10 cycles
DIN IEC 68 part 2 – 14 Test N
- 4. Resistance to solder heat (reflow): reflow possible: twice max.;
for temperature conditions refer to the attached "Air reflow temperature conditions" on page 4;

Packing

Tape & Reel: IEC 286 – 3, with exception of value for N and minimum bending radius;
tape type II, embossed carrier tape with top cover tape on the upper side;

max. pieces of filters peer reel: 3000
 reel of empty components at start: min. 300 mm
 reel of empty components at start including leader: min. 500 mm
 trailer: min. 300 mm

Tape (all dimensions in mm)

- W : 12,00 ± 0,3
- Po : 4,00 ± 0,1
- Do : 1,50 +0,1/-0
- E : 1,75 ± 0,1
- F : 5,50 ± 0,05
- G(min) : 0,75
- P2 : 2,00 ± 0,05
- P1 : 8,00 ± 0,1
- D1(min) : 1,50
- Ao : 4,30 ± 0,1
- Bo : 4,30 ± 0,1
- Ct : 9,5 ± 0,1

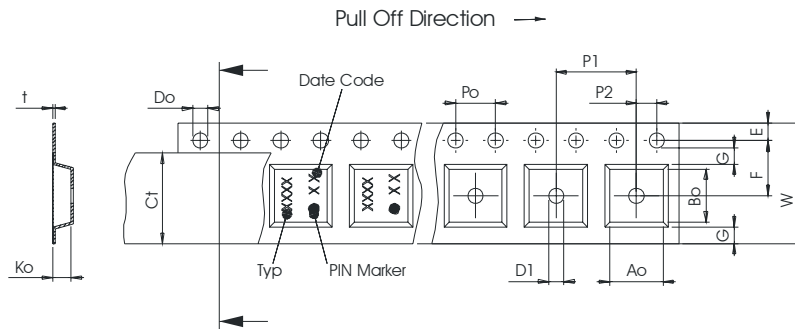

Reel (all dimensions in mm)

- A : 330
- W1 : 12,4 +2/-0
- W2(max) : 18,4
- N(min) : 50
- C : 13,0 +0,5/-0,2

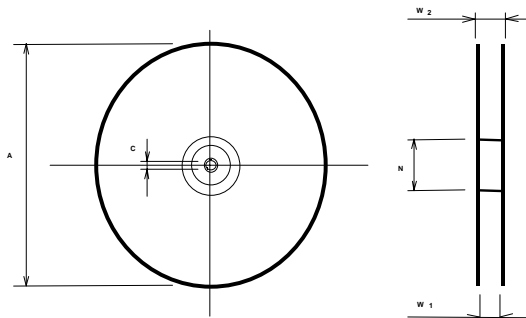

The minimum bending radius is 45 mm.

Tele Filter GmbH
Potsdamer Straße 18
D 14 513 TELTOW / Germany
Tel: (+49) 3328 4784-0 / Fax: (+49) 3328 4784-30
E-Mail: tft@telefilter.com

VI TELEFILTER reserves the right to make changes to the product(s) and/or information contained herein without notice. No liability is assumed as a result of their use or application. No rights under any patent accompany the sale of any such product(s) or information.

Air reflow temperature conditions

Conditions	Exposure
Average ramp-up rate (30°C to 217°C)	less than 3°C/second
> 100°C	between 300 and 600 seconds
> 150°C	between 240 and 500 seconds
> 217°C	between 30 and 150 seconds
Peak temperature	max. 260°C
Time within 5°C of actual peak temperature	between 10 and 30 seconds
Cool-down rate (Peak to 50°C)	less than 6°C/second
Time from 30°C to Peak temperature	no greater than 300 seconds

Chip-mount air reflow profile

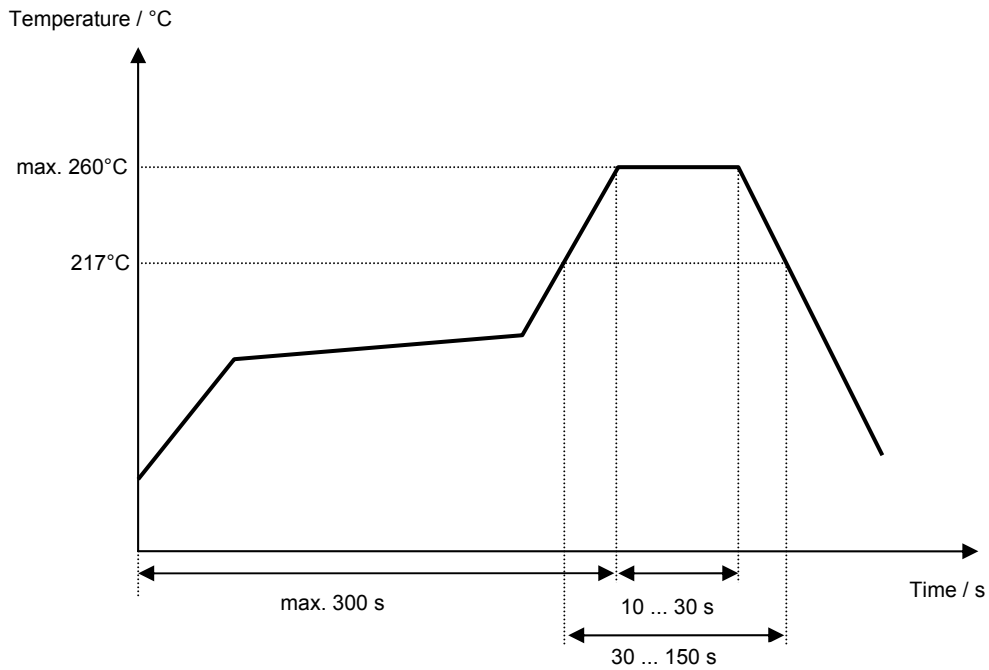

Tele Filter GmbH
Potsdamer Straße 18
D 14 513 TELTOW / Germany
Tel: (+49) 3328 4784-0 / Fax: (+49) 3328 4784-30
E-Mail: tft@telefilter.com

VI TELEFILTER reserves the right to make changes to the product(s) and/or information contained herein without notice. No liability is assumed as a result of their use or application. No rights under any patent accompany the sale of any such product(s) or information.

VI TELEFILTER**Resonator specification****TFR 315B****5/5**

History

Version	Reason of Changes	Name	Date
1.0	- generation of development specification	Steiner	05.09.2005
1.1	- added resonator characteristic; generation of resonator specification	Martens	23.09.2005

Tele Filter GmbH
Potsdamer Straße 18
D 14 513 TELTOW / Germany
Tel: (+49) 3328 4784-0 / Fax: (+49) 3328 4784-30
E-Mail: tft@telefilter.com

VI TELEFILTER reserves the right to make changes to the product(s) and/or information contained herein without notice. No liability is assumed as a result of their use or application. No rights under any patent accompany the sale of any such product(s) or information.