

Female Signal Modules — Pressfit Termination — Pushfit Retention — 4 Row

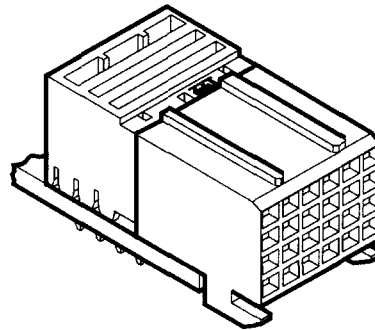

Features

- Designed to conform with IEC 48b237, EIAis64, IEEE P896 Futurebus+, IEEE P1596 SCI and IEC 917 metric modular order
- Stackable with other TEMPUS modules, with no loss of positions
- Pushfit peg retention
- High performance contacts, high hertz stress, 1000 cycles minimum
- High I/O, 20 contacts per linear centimetre (51 contacts per linear inch)
- High temperature materials, not affected by reflow solder process
- Simple 'flat rock type' application tooling
- 45° legform for optimum electrical performance

Technical Data

Mechanical Data

Contact Pitch	2,00 x 2,00 (.079 x .079)
Polarisation	By design
Coding	With coding keys, see page 56
Housing Material	Liquid Crystal Polymer, UL94V-0
Termination	Eye of needle compliant section, tin/lead plated
Termination p.t.h.	Ø 0,70 (.028), refer to page 65
Board Retention	Pushfit peg
Contact Material	Phosphor bronze
Hertz Stress	1200 MPa (174 kbf/sq. in.)
Class 1	1000 cycles minimum
Plating	Palladium Nickel plus Gold over Nickel
Insertion Force	0,45 N (1.6 oz) max. per contact
Withdrawal Force	0,15 N (0.5 oz) min. per contact

Electrical Data

Current Rating	1,50 A at 25°C, 1 A at 70°C
Withstanding Voltage	1000 Vrms
Insulation Resistance	Initial : 5000 MΩ After climatic test : 1000 MΩ
Contact Resistance	45 mΩ maximum

Female Signal Modules — Pressfit Termination — Pushfit Retention — 4 Row

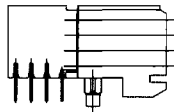
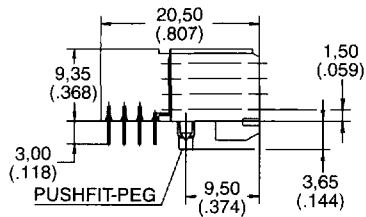

Detail Press-Fit

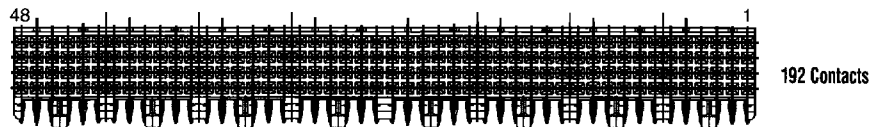
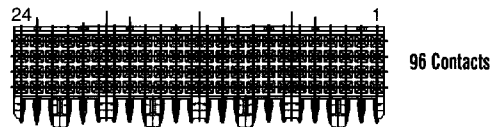
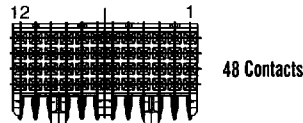
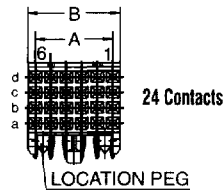
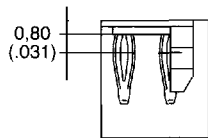

Recommended P.C.B. Hole Pattern, Component Side

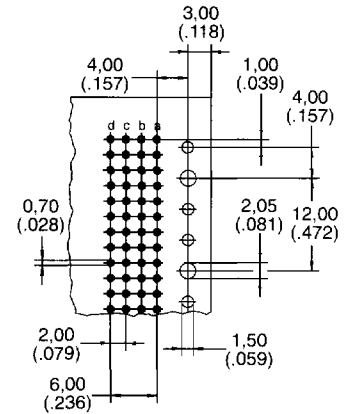

Refer to Design Notes on page 65 for circuit board drill and hole plating details.

No. of Contacts	Part Number	A	B	Availability
24	CBC20P00-024FDP1-0-1-002	10,00 (.394)	11,95 (.470)	consult ITT Cannon
48	CBC20Q00-048FDP1-0-1-002	22,00 (.866)	23,95 (.943)	consult ITT Cannon
96	CBC20R00-096FDP1-0-1-002	46,00 (1.811)	47,95 (1.888)	consult ITT Cannon
192	CBC20S00-192FDP1-0-1-002	94,00 (3.701)	95,95 (3.778)	Planned

Packaging Quantity

Contacts	In Tube	In Tray
24	44	286
48	22	143
96	11	65
192	5	26

All part numbers shown in this publication refer to connectors supplied in trays. For connectors supplied in tubes add the designation **-VR** to the end of the part number.

Note:
Minimum order quantities apply

Long pushfit peg (-002) enables fast assembly of the connector to the circuit board.

Pushfit peg (-002) is designed to work with wide wall male modules and narrow wall modules incorporating a slot.

A short pushfit peg is available to work with narrow wall modules without a slot (replace -002 with -001).

Performance 1000 mating cycles