

General Description

Switching regulator and DC-DC Converter applications.
It's mainly suitable for Back-light Inverter.

FEATURES

- N-Channel
 - : $V_{DSS}=30V$, $I_D=7A$.
 - : $R_{DS(ON)}=23.5m$ (Max.) @ $V_{GS}=10V$
 - : $R_{DS(ON)}=39m$ (Max.) @ $V_{GS}=4.5V$
- P-Channel
 - : $V_{DSS}=-30V$, $I_D=-5A$.
 - : $R_{DS(ON)}=45.5m$ (Max.) @ $V_{GS}=-10V$
 - : $R_{DS(ON)}=80m$ (Max.) @ $V_{GS}=-4.5V$
- Super High Dense Cell Design.
- Reliable and rugged.

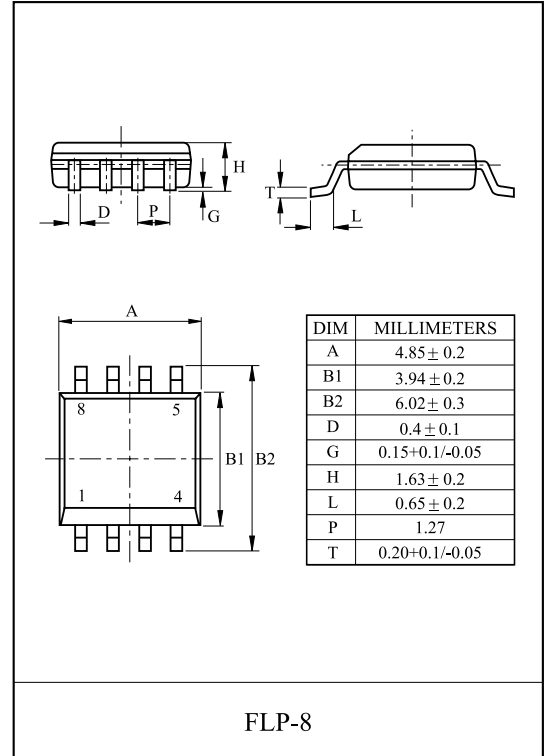

MAXIMUM RATING (Ta=25 °C)

CHARACTERISTIC		SYMBOL	N-Ch	P-Ch	UNIT
Drain-Source Voltage		V_{DSS}	30	-30	V
Gate-Source Voltage		V_{GSS}	± 20	± 20	V
Drain Current	DC	I_D^*	7	-5	A
	Pulsed (note1)	I_{DP}	29	-20	
Source-Drain Diode Current		I_S	1.7	-1.7	A
Drain Power Dissipation		P_D^*	2		W
Maximum Junction Temperature		T_j	150		
Storage Temperature Range		T_{stg}	-55 150		
Thermal Resistance, Junction to Ambient		R_{thJA}^*	62.5		/W

Note : *Surface Mounted on FR4 Board

PIN CONNECTION (TOP VIEW)

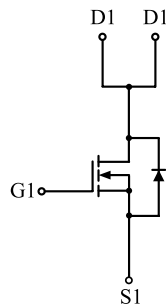
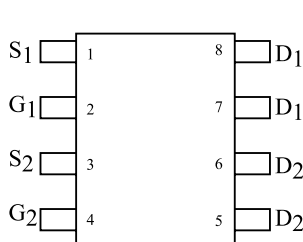

N-Channel MOSFET

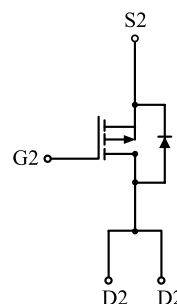

P-Channel MOSFET

KMB7D0NP30QA

ELECTRICAL CHARACTERISTICS (Ta=25 °C)

CHARACTERISTIC	SYMBOL	TEST CONDITION		MIN.	TYP.	MAX.	UNIT
Static							
Drain-Source Breakdown Voltage	BV _{DSS}	I _D =250 μA, V _{GS} =0V,	N-Ch	30	-	-	V
		I _D =-250 μA, V _{GS} =0V,	P-Ch	-30	-	-	
Drain Cut-off Current	I _{DSS}	V _{GS} =0V, V _{DS} =24V	N-Ch	-	-	1	μA
		V _{GS} =0V, V _{DS} =-24V	P-Ch	-	-	-1	
Gate Leakage Current	I _{GSS}	V _{GS} = ± 20V, V _{DS} =0V	N-Ch	-	-	± 100	nA
			P-Ch	-	-	± 100	
Gate Threshold Voltage	V _{th}	V _{DS} =V _{GS} , I _D =250 μA	N-Ch	1.0	-	3	V
		V _{DS} =V _{GS} , I _D =-250 μA	P-Ch	-1.0	-	-3	
Drain-Source ON Resistance	R _{DS(ON)} *	V _{GS} =10V, I _D =7A	N-Ch	-	18	23.5	m
		V _{GS} =-10V, I _D =-5A	P-Ch	-	35	45.5	
		V _{GS} =4.5V, I _D =6A	N-Ch	-	30	39	
		V _{GS} =-4.5V, I _D =-4A	P-Ch	-	62	80	
ON State Drain Current	I _{D(ON)} *	V _{GS} =4.5V, V _{DS} =5V	N-Ch	20	-	-	A
		V _{GS} =-10V, V _{DS} =-5V	P-Ch	-20	-	-	
Forward Transconductance	g _{fs} *	V _{DS} =5V, I _D =6.6A	N-Ch	-	10	-	S
		V _{DS} =-5V, I _D =-5A	P-Ch	-	9	-	
Source-Drain Diode Forward Voltage	V _{SD} *	I _S =1.7A, V _{GS} =0V	N-Ch	-	0.7	1.2	V
		I _S =-1.7A, V _{GS} =0V	P-Ch	-	-0.8	-1.2	

KMB7D0NP30QA

ELECTRICAL CHARACTERISTICS (Ta=25)

CHARACTERISTIC	SYMBOL	TEST CONDITION	MIN.	TYP.	MAX.	UNIT		
Dynamic								
Total Gate Charge	Q _g	N-Ch : V _{DS} =15V, I _D =6.6A, V _{GS} =10V (Fig.1)	N-Ch	-	16.4	20.5	nC	
			P-Ch	-	13	16		
		P-Ch : V _{DS} =-15V, I _D =-5A, V _{GS} =-10V (Fig.3)	N-Ch	-	7.2	9		
			P-Ch	-	6.25	7.8		
Gate-Source Charge	Q _{gs}	N-Ch : V _{DS} =15V, I _D =6.6A, V _{GS} =10V (Fig.1)	N-Ch	-	4	-		
Gate-Drain Charge	Q _{gd}		P-Ch : V _{DS} =-15V, I _D =-5A, V _{GS} =-10V (Fig.3)	P-Ch	-	2.6		-
		N-Ch		-	2.6	-		
P-Ch	-	2.9	-					
Turn-on Delay time	t _{d(on)}	N-Ch : V _{DD} =15V, I _D =6.6A, V _{GS} =10V, R _G =3 (Fig.2)	N-Ch	-	7.4	-	ns	
Turn-on Rise time	t _r		P-Ch	-	4.7	-		
			N-Ch	-	27.7	-		
Turn-off Delay time	t _{d(off)}		P-Ch : V _{DD} =-15V, V _{GS} =-10V, R _G =3 , R _L =2.7 (Fig.4)	P-Ch	-	7.8		-
				N-Ch	-	12.2		-
Turn-off Fall time	t _f		P-Ch	-	47.2	-		
			N-Ch	-	7.6	-		
P-Ch	-		22.6	-				
Input Capacitance	C _{iss}	N-Ch : V _{DS} =15V, V _{GS} =0V, f=1.0MHz	N-Ch	-	742	-	pF	
Output Capacitance	C _{oss}		P-Ch : V _{DS} =-15V, V _{GS} =0V, f=1.0MHz	P-Ch	-	820		-
				N-Ch	-	126		-
Reverse transfer Capacitance	C _{rss}		P-Ch	-	137	-		
			N-Ch	-	76	-		
P-Ch	-		89	-				

Note 1>* Pulse test : Pulse width 300μs, Duty Cycle 2%.

KMB7D0NP30QA

N-Channel

Fig1. $I_D - V_{DS}$

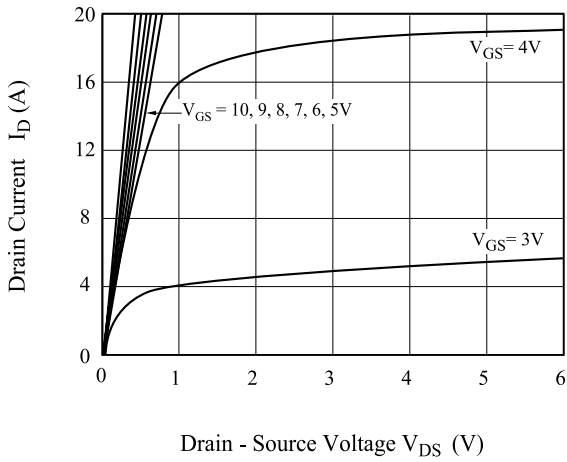

Fig2. $I_D - V_{GS}$

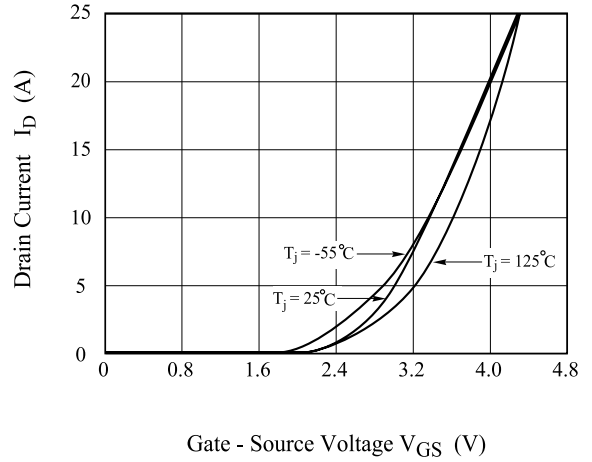

Fig3. $V_{th} - T_j$

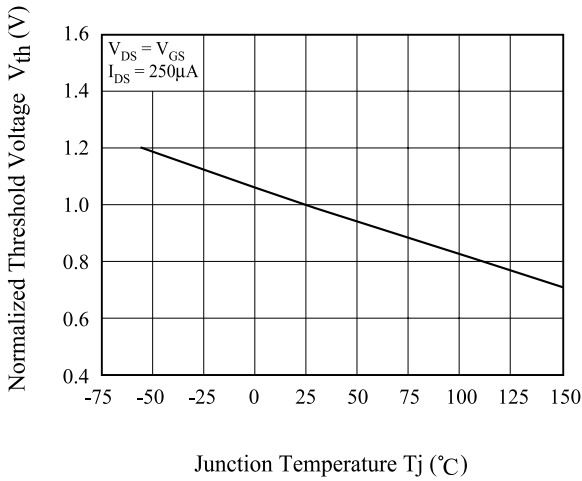

Fig4. $I_{DR} - V_{SD}$

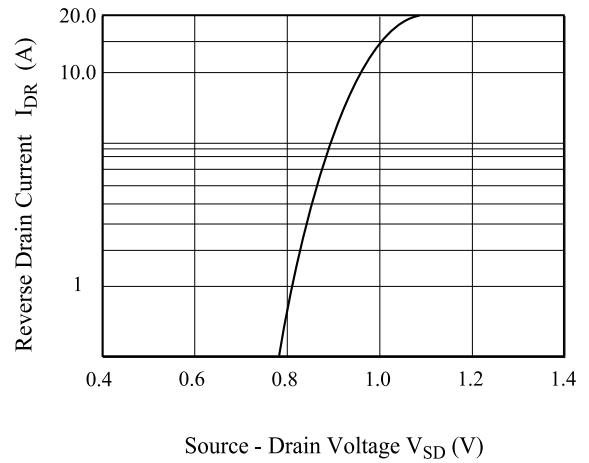

Fig5. $R_{DS(ON)} - T_j$

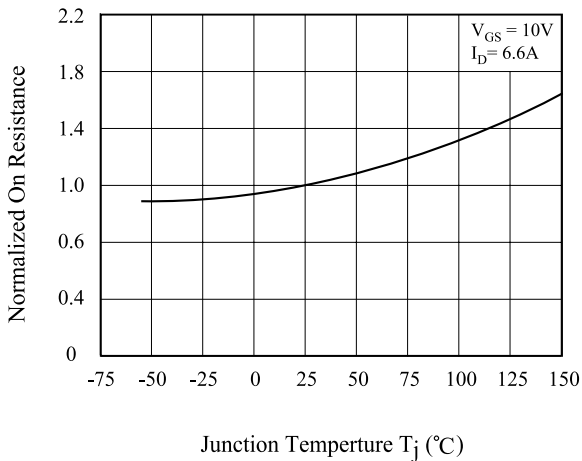
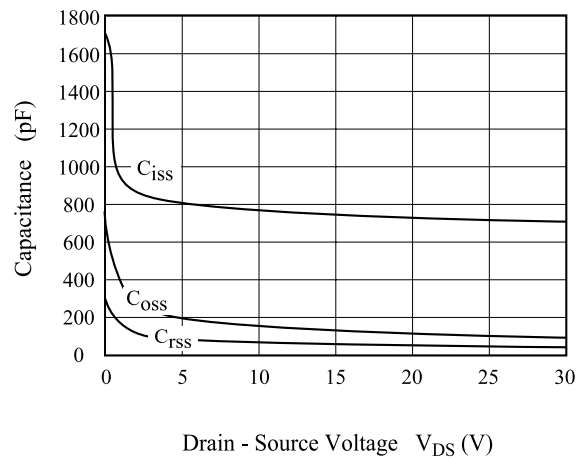

Fig6. $C - V_{DS}$



KMB7D0NP30QA

Fig7. $Q_g - V_{GS}$

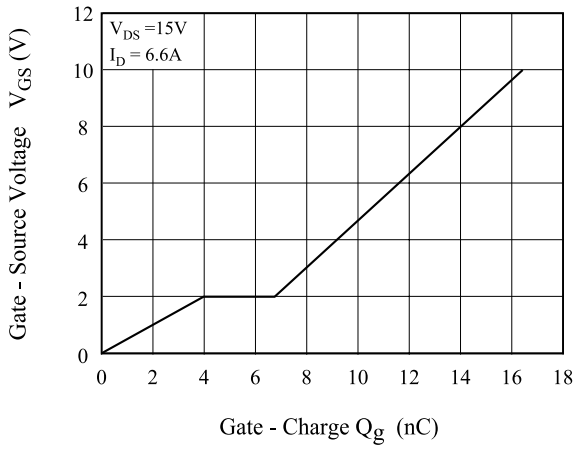

Fig8. Safe Operation Area

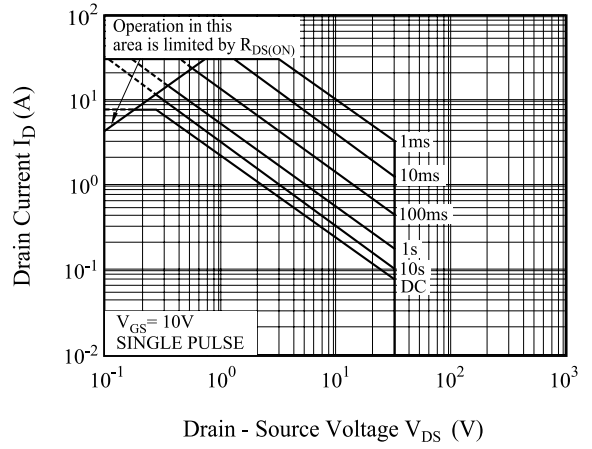
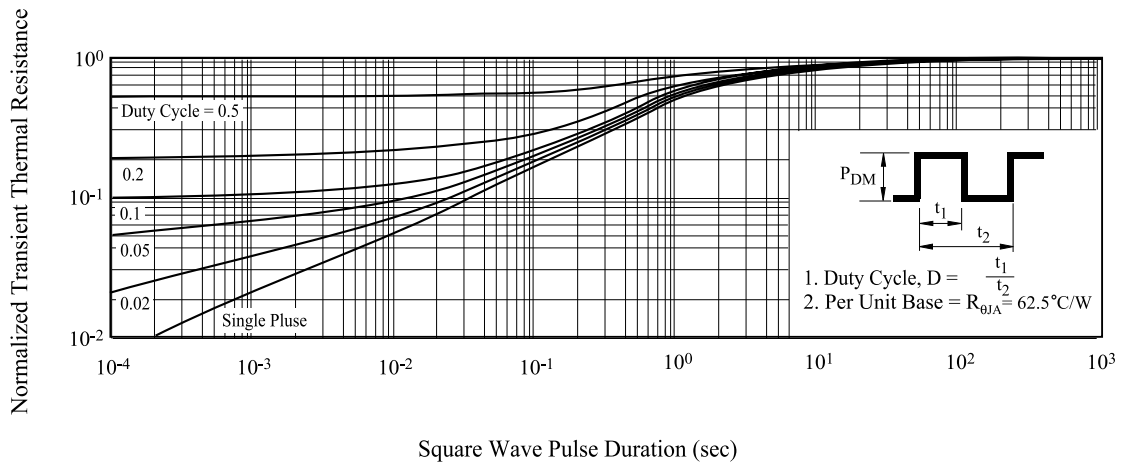

Fig9. Transient Thermal Response Curve



KMB7D0NP30QA

P-Channel

Fig1. $I_D - V_{DS}$

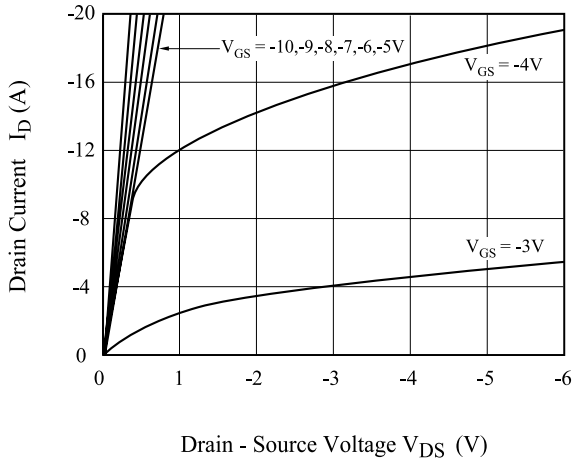

Fig2. $I_D - V_{GS}$

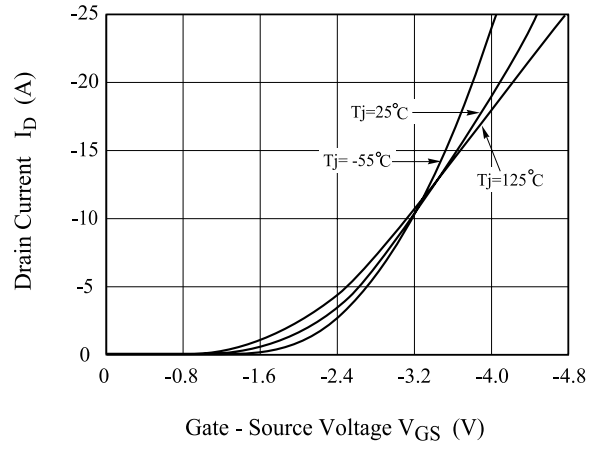

Fig3. $V_{th} - T_J$

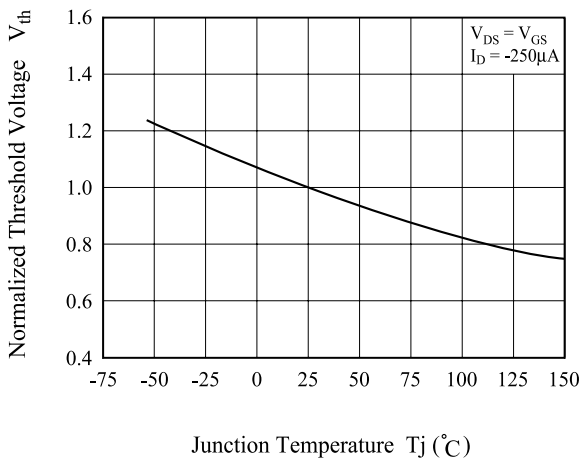

Fig4. $I_{DR} - V_{SD}$

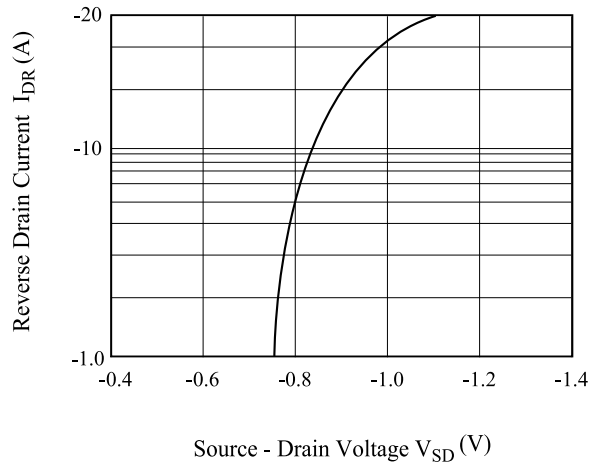

Fig5. $R_{DS(ON)} - T_J$

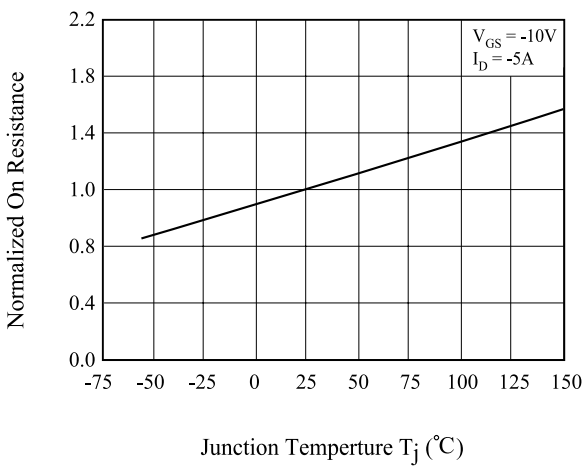
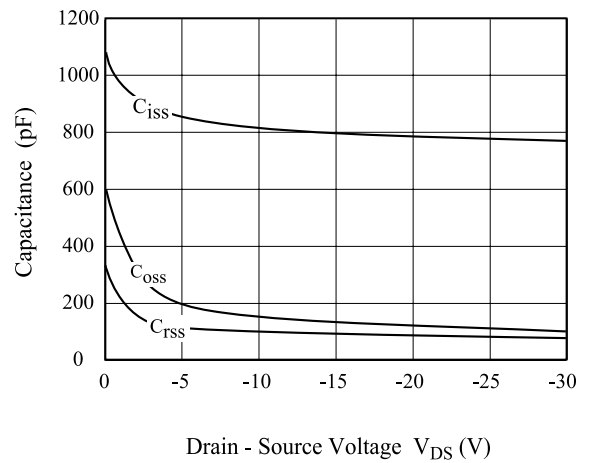

Fig6. $C - V_{DS}$



KMB7D0NP30QA

Fig7. $Q_g - V_{GS}$

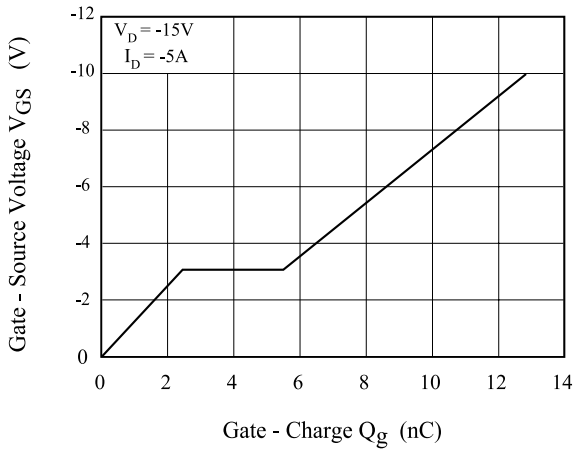

Fig8. Safe Operation Area

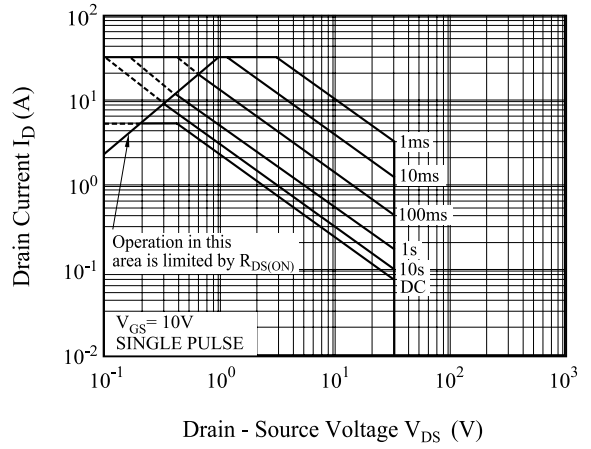
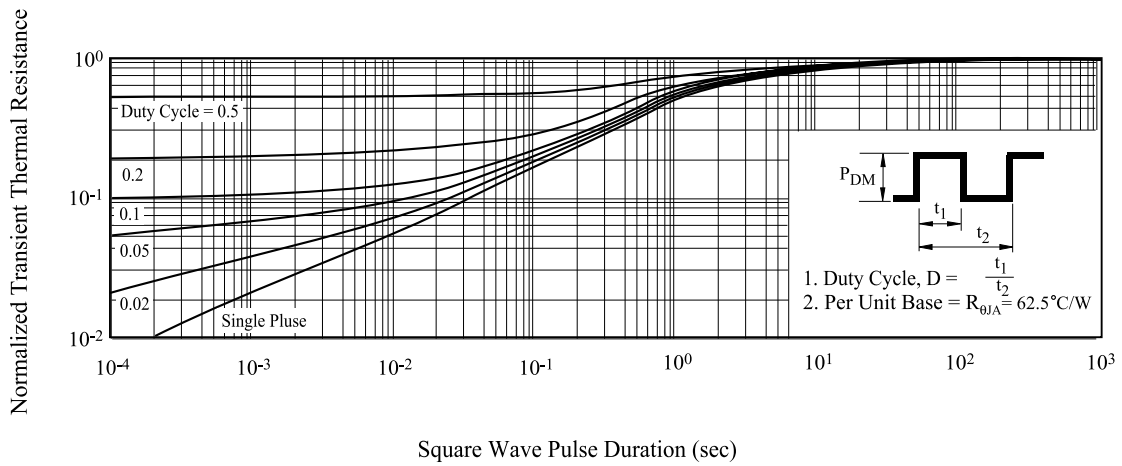

Fig9. Transient Thermal Response Curve



KMB7D0NP30QA

N-Channel

Fig. 1 Gate Charge

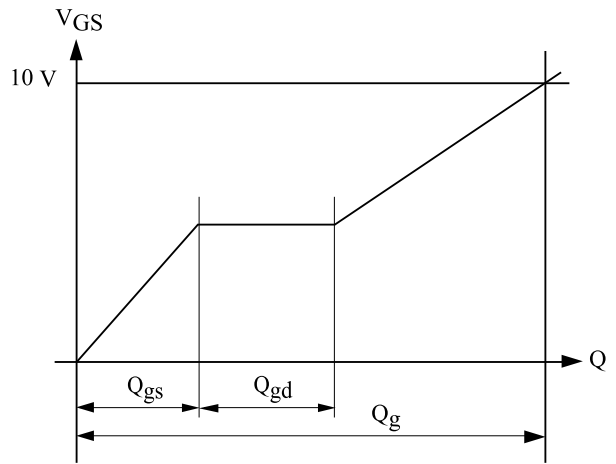
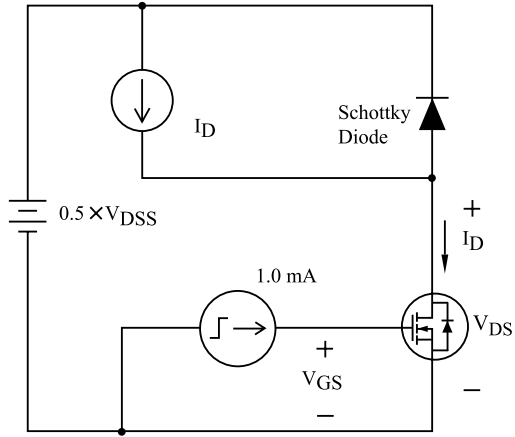
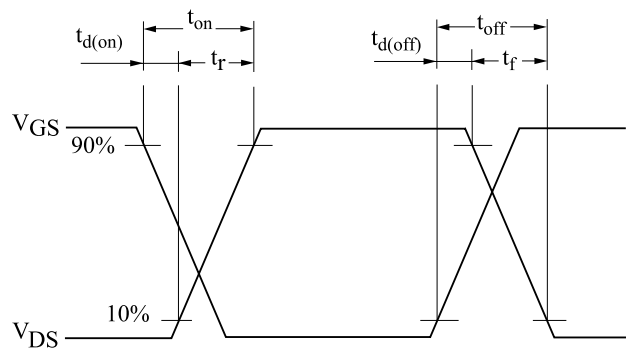
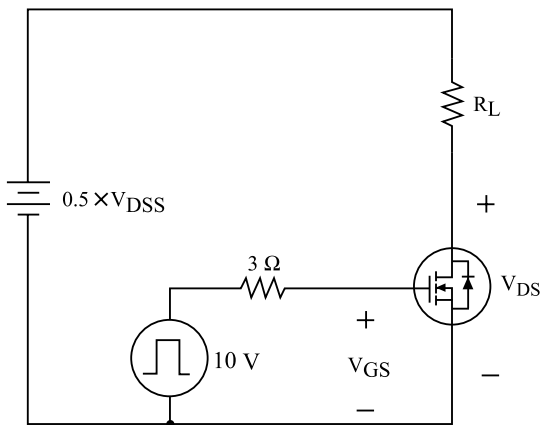

Fig. 2 Resistive Load Switching



KMB7D0NP30QA

P-Channel

Fig. 1 Gate Charge

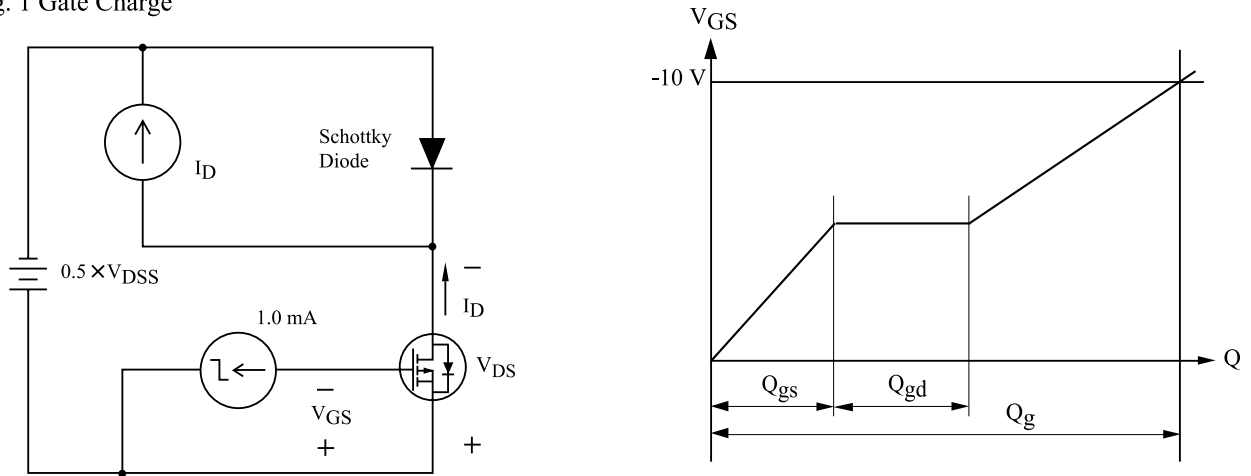

Fig. 2 Resistive Load Switching

