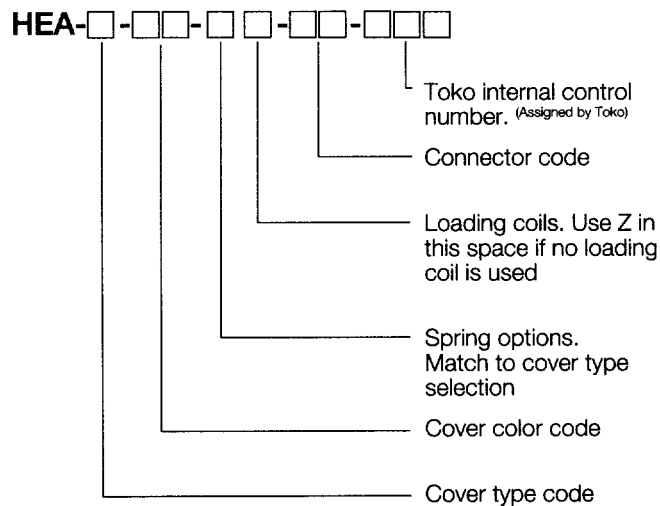

HEA Series**Features**

- 46/49MHz antenna suitable for 25 channel phone
- 900MHz antenna
- Available in 8 colors
- Flexible elastomer cover
- Most common connector styles available

Description

The HEA Series is a helical antenna suitable for 46/49MHz or 900MHz cordless phones and other wireless applications. The antenna features a flexible elastomer cover in a variety of colors.

PART NUMBERING CODE**ANTENNA SELECTION**

1. Please select the length/dimensions, color and mounting method required for your design.
2. If you wish to extend the receiving frequency range of your set under the same conditions, we recommend models with a loading coil. Since, Spring Coils will not be used enter a Z for Spring options.

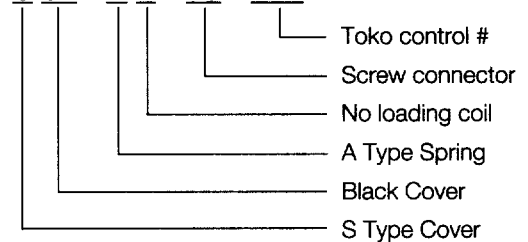
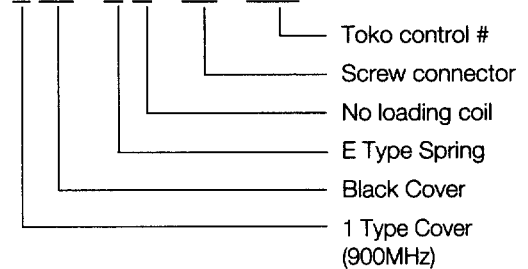
EXAMPLE: 1 46/49MHz**HEA -S 01 - A Z - 15 - 001****EXAMPLE: 2 900MHz****HEA -1 01 - E Z - 20 - 000****SPECIFICATIONS****Electrical Characteristics**

Operating frequency	In accordance with individual specifications
Impedance	50 Nominal
Power	2Max.
Voltage	500M , Min./500VDC
Power	1500VAC, 1 Minute
Wave length	1/4 λ

Mechanical Characteristics

Weighted strength of connector	49N (5kg), Min.
Weighted strength of antenna	49N-cm (5kg-cm), Min.
Length	1mm, Max.

Environmental Characteristics

Temperature loading	-10° C/+65° C, at 3 hr per cycle No electrical or mechanical defect to be detected
Operating temperature range	-20° C to +60° C
Storage temperature	-30° C to +80° C

COLOR OPTIONS

COLOR CODE	COLORS
01	BLACK
02	GRAY
03	LIGHT GRAY
05	MILKY WHITE
06	NEW IVORY
07	DARK GRAY
14	WHITE GRAY
15	WARM GRAY

CIRCUIT EXAMPLE

Cordless phone front end

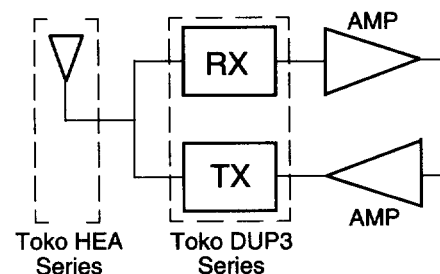

COVER TYPE OPTIONS

Basic selection Unit: mm

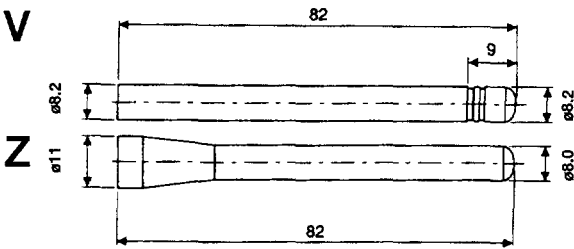
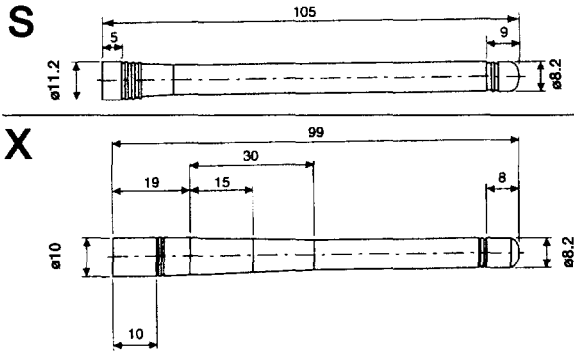

Connectors for Z type covers are designed to prevent spring rotation.

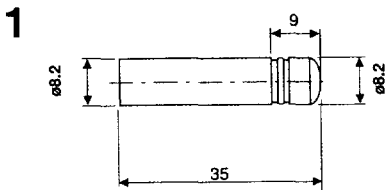
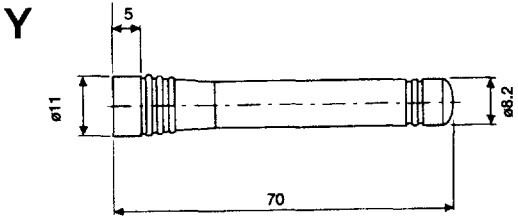

SPRING OPTIONS

Compulsory settings based on cover type

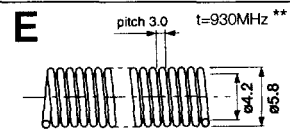
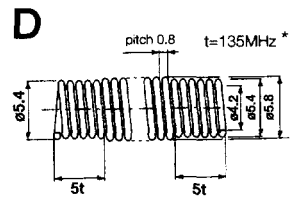
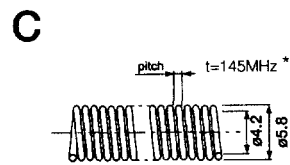
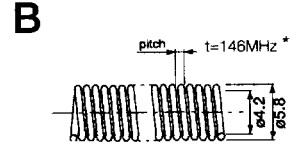
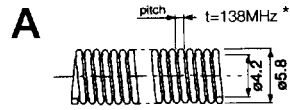

* For 46MHz Phone
** For 900MHz Phone

Unit: mm

LOADING COIL OPTIONS

Limited Settings Unit: mm

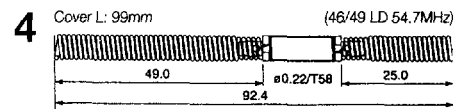
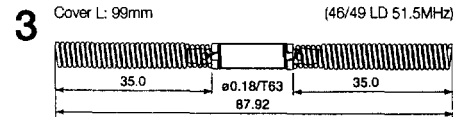
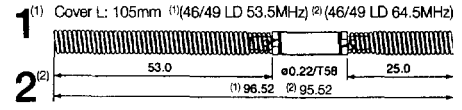

No loading coil for cover options V & Z

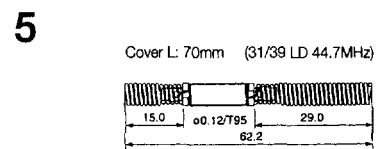

No loading coil for cover options 1

CONNECTOR OPTIONS

Options Unit: mm

