



Features:

- Zinc Diecast shell.
- The P size housing is the original wide flange front mounting XLR connector. PN is the original narrow, front mounting male connector.
- Solder Bucket connections.
- Vertical PCB mounting.
- Precision Machined or Stamped contacts (3 pin only).
- Leading first mate last break socket contact.
- Positive latch lock system.

Options: Stamped contacts (3 contact only), Gold plated contacts, Vertical PCB contacts, Black Finish, Non-Latching (Female only), Bulk Pack.

Part Number Breakdown: Page 24











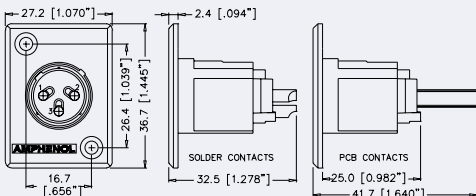



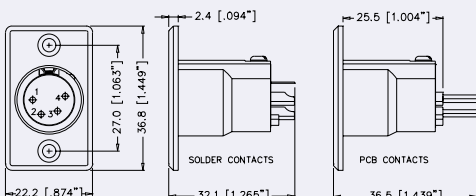



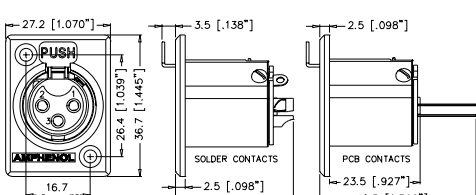



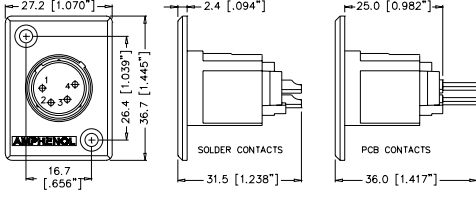

Specifications: Page 25

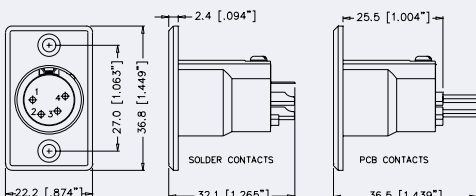





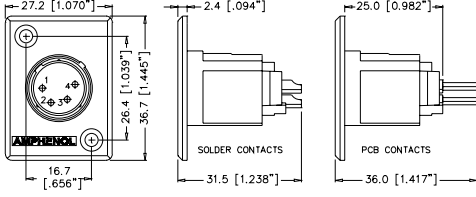

PCB Footprints: Page 26

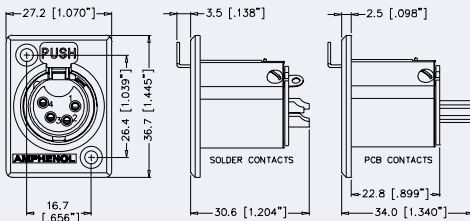
Panel Cutouts: Page 26

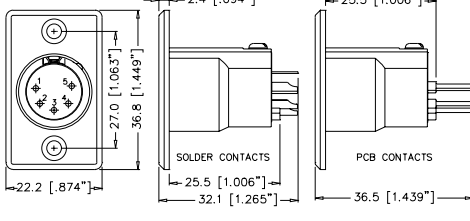

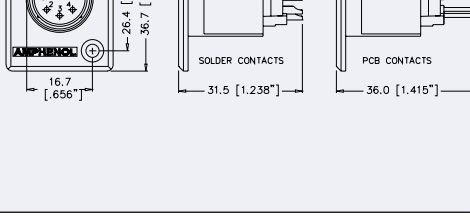
PRODUCT - FIGURE	DRAWING	DESCRIPTION	VARIATIONS	PART NUMBER
	<p>Dimensions in mm (inches)</p> <p>2.4 [.094"]</p> <p>25.5 [1.004"]</p> <p>27.0 [1.063"]</p> <p>36.8 [1.449"]</p> <p>22.2 [.874"]</p> <p>32.1 [1.265"]</p> <p>36.5 [1.437"]</p> <p>SOLDER CONTACTS</p> <p>PCB CONTACTS</p>	XLR 3 pole male, Narrow flange, Machined contacts, Nickel Finish	Standard	AC3MMPNZ
			Gold Plated Contacts	AC3MMPNZ-AU
	<p>Dimensions in mm (inches)</p> <p>2.4 [.094"]</p> <p>25.5 [1.004"]</p> <p>27.0 [1.063"]</p> <p>36.8 [1.449"]</p> <p>22.2 [.874"]</p> <p>32.1 [1.265"]</p> <p>36.5 [1.437"]</p> <p>SOLDER CONTACTS</p> <p>PCB CONTACTS</p>	XLR 3 pole male, Narrow flange, Machined contacts, Black Finish	Vertical PCB	AC3MMPNZV
			Gold Plated Contacts	AC3MMPNZB-AU
	<p>Dimensions in mm (inches)</p> <p>2.4 [.094"]</p> <p>25.5 [1.004"]</p> <p>27.0 [1.063"]</p> <p>36.8 [1.449"]</p> <p>22.2 [.874"]</p> <p>32.1 [1.265"]</p> <p>36.5 [1.437"]</p> <p>SOLDER CONTACTS</p> <p>PCB CONTACTS</p>	XLR 3 pole male, Narrow flange, Stamped contacts, Nickel Finish	Bulk Pack	AC3MMPNZ BULK
			Vertical PCB	AC3MMPNZVB
	<p>Dimensions in mm (inches)</p> <p>2.4 [.094"]</p> <p>25.5 [1.004"]</p> <p>27.0 [1.063"]</p> <p>36.8 [1.449"]</p> <p>22.2 [.874"]</p> <p>32.1 [1.265"]</p> <p>36.5 [1.437"]</p> <p>SOLDER CONTACTS</p> <p>PCB CONTACTS</p>	XLR 3 pole male, Narrow flange, Stamped contacts, Black Finish	Bulk Pack	AC3MMPNZ BULK
			Standard	AC3MMP
	<p>Dimensions in mm (inches)</p> <p>27.2 [1.070"]</p> <p>2.4 [.094"]</p> <p>25.0 [0.982"]</p> <p>26.4 [1.039"]</p> <p>36.7 [1.445"]</p> <p>16.7 [.656"]</p> <p>31.5 [1.238"]</p> <p>36.0 [1.415"]</p> <p>SOLDER CONTACTS</p> <p>PCB CONTACTS</p>	XLR 3 pole male, Wide flange, Machined contacts, Nickel Finish	Gold Plated Contacts	AC3MMP-AU
			Vertical PCB	AC3MMPV
	<p>Dimensions in mm (inches)</p> <p>27.2 [1.070"]</p> <p>2.4 [.094"]</p> <p>25.0 [0.982"]</p> <p>26.4 [1.039"]</p> <p>36.7 [1.445"]</p> <p>16.7 [.656"]</p> <p>31.5 [1.238"]</p> <p>36.0 [1.415"]</p> <p>SOLDER CONTACTS</p> <p>PCB CONTACTS</p>	XLR 3 pole male, Wide flange, Machined contacts, Black Finish	Bulk Pack	AC3MMP BULK
			Standard	AC3MMPB
	<p>Dimensions in mm (inches)</p> <p>27.2 [1.070"]</p> <p>2.4 [.094"]</p> <p>25.0 [0.982"]</p> <p>26.4 [1.039"]</p> <p>36.7 [1.445"]</p> <p>16.7 [.656"]</p> <p>31.5 [1.238"]</p> <p>36.0 [1.415"]</p> <p>SOLDER CONTACTS</p> <p>PCB CONTACTS</p>	XLR 3 pole male, Wide flange, Stamped contacts, Black Finish	Gold Plated Contacts	AC3MMPB-AU
			Vertical PCB	AC3MMPVB
	<p>Dimensions in mm (inches)</p> <p>27.2 [1.070"]</p> <p>2.4 [.094"]</p> <p>25.0 [0.982"]</p> <p>26.4 [1.039"]</p> <p>36.7 [1.445"]</p> <p>16.7 [.656"]</p> <p>31.5 [1.238"]</p> <p>36.0 [1.415"]</p> <p>SOLDER CONTACTS</p> <p>PCB CONTACTS</p>	XLR 3 pole male, Wide flange, Stamped contacts, Black Finish	Bulk Pack	AC3MMPB BULK

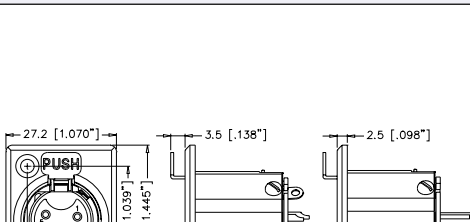

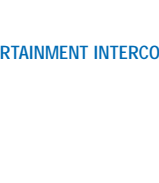

PRODUCT - FIGURE	DRAWING	DESCRIPTION	VARIATIONS	PART NUMBER
		XLR 3 pole male, Wide flange, Stamped contacts, Nickel Finish	Standard	AC3MP
			Gold Plated Contacts	AC3MP-AU
			Vertical PCB	AC3MPV
			Bulk Pack	AC3MP BULK
		XLR 3 pole male, Wide flange, Stamped contacts, Black Finish	Standard	AC3MPB
			Gold Plated Contacts	AC3MPB-AU
			Vertical PCB	AC3MPVB
			Bulk Pack	AC3MPB BULK
		XLR 3 pole female, Wide flange, Stamped contacts, Nickel Finish	Standard	AC3FPZ
			Gold Plated Contacts	AC3FPZ-AU
			Vertical PCB	AC3FPZV
			Bulk Pack	AC3FPZ BULK
		XLR 3 pole female, Wide flange, Stamped contacts, Black Finish	Standard	AC3FPZB
			Gold Plated Contacts	AC3FPZB-AU
			Vertical PCB	AC3FPZVB
			Bulk Pack	AC3FPZB BULK
		XLR 4 pole male, Narrow flange, Machined contacts, Nickel Finish	Standard	AC4MPNZ
			Gold Plated Contacts	AC4MPNZ-AU
			Vertical PCB	AC4MPNZV
			Bulk Pack	AC4MPNZ BULK
		XLR 4 pole male, Narrow flange, Machined contacts, Black Finish	Standard	AC4MPNZB
			Gold Plated Contacts	AC4MPNZB-AU
			Vertical PCB	AC4MPNZVB
			Bulk Pack	AC4MPNZB BULK
		XLR 4 pole male, Wide flange, Machined contacts, Nickel Finish	Standard	AC4MP
			Gold Plated Contacts	AC4MP-AU
			Vertical PCB	AC4MPV
			Bulk Pack	AC4MP BULK
		XLR 4 pole male, Wide flange, Machined contacts, Black Finish	Standard	AC4MPB
			Gold Plated Contacts	AC4MPB-AU
			Vertical PCB	AC4MPVB
			Bulk Pack	AC4MPB BULK

PRODUCT - FIGURE	DRAWING	DESCRIPTION	VARIATIONS	PART NUMBER
		XLR 4 pole female, Wide flange, Stamped contacts, Nickel Finish	Standard	AC4FPZ
			Gold Plated Contacts	AC4FPZ- AU
			Vertical PCB	AC4FPZV
			Bulk Pack	AC4FPZ BULK
		XLR 4 pole female, Wide flange, Stamped contacts, Black Finish	Standard	AC4FPZB
			Gold Plated Contacts	AC4FPZB- AU
			Vertical PCB	AC4FPZVB
			Bulk Pack	AC4FPZB BULK
		XLR 5 pole male, Narrow flange, Machined contacts, Nickel Finish	Standard	AC5MPNZ
			Gold Plated Contacts	AC5MPNZ- AU
			Vertical PCB	AC5MPNZV
			Bulk Pack	AC5MPNZ BULK
		XLR 5 pole male, Narrow flange, Machined contacts, Black Finish	Standard	AC5MPNZB
			Gold Plated Contacts	AC5MPNZB- AU
			Vertical PCB	AC5MPNZVB
			Bulk Pack	AC5MPNZB BULK
		XLR 5 pole male, Wide flange, Machined contacts, Nickel Finish	Standard	AC5MP
			Gold Plated Contacts	AC5MP- AU
			Vertical PCB	AC5MPV
			Bulk Pack	AC5MP BULK
		XLR 5 pole male, Wide flange, Machined contacts, Black Finish	Standard	AC5MPB
			Gold Plated Contacts	AC5MPB- AU
			Vertical PCB	AC5MPVB
			Bulk Pack	AC5MPB BULK
		XLR 5 pole female, Wide flange, Machined contacts, Nickel Finish	Standard	AC5FPZ
			Gold Plated Contacts	AC5FPZ- AU
			Vertical PCB	AC5FPZV
			Bulk Pack	AC5FPZ BULK
		XLR 5 pole female, Wide flange, Machined contacts, Black Finish	Standard	AC5FPZB
			Gold Plated Contacts	AC5FPZB- AU
			Vertical PCB	AC5FPZVB
			Bulk Pack	AC5FPZB BULK



PRODUCT - FIGURE	DRAWING	DESCRIPTION	VARIATIONS	PART NUMBER
		XLR 6A pole male, Narrow flange, Machined contacts, Nickel Finish	Standard	AC6AMPNZ
			Gold Plated Contacts	AC6AMPNZ- AU
			Vertical PCB	AC6AMPNZV
			Bulk Pack	AC6AMPNZ BULK
		XLR 6A pole male, Narrow flange, Machined contacts, Black Finish	Standard	AC6AMPNZB
			Gold Plated Contacts	AC6AMPNZB- AU
			Vertical PCB	AC6AMPNZVB
			Bulk Pack	AC6AMPNZB BULK
		XLR 6A pole male, Wide flange, Machined contacts, Nickel Finish	Standard	AC6AMP
			Gold Plated Contacts	AC6AMP- AU
			Vertical PCB	AC6AMPV
			Bulk Pack	AC6AMP BULK
		XLR 6A pole male, Wide flange, Machined contacts, Black Finish	Standard	AC6AMPB
			Gold Plated Contacts	AC6AMPB- AU
			Vertical PCB	AC6AMPVB
			Bulk Pack	AC6AMPB BULK
		XLR 6A pole female, Wide flange, Machined contacts, Nickel Finish	Standard	AC6AFPZ
			Gold Plated Contacts	AC6AFPZ- AU
			Vertical PCB	AC6AFPZV
			Bulk Pack	AC6AFPZ BULK
		XLR 6A pole female, Wide flange, Machined contacts, Black Finish,	Standard	AC6AFPZB
			Gold Plated Contacts	AC6AFPZB- AU
			Vertical PCB	AC6AFPZVB
			Bulk Pack	AC6AFPZB BULK
		XLR 7 pole male, Narrow flange, Gold Plated Machined contacts, Nickel Finish	Standard	AC7MPNZ
			Vertical PCB	AC7MPNZV
			Bulk Pack	AC7MPNZ BULK
		XLR 7 pole male, Narrow flange, Gold Plated Machined contacts, Black Finish	Standard	AC7MPNZB
			Vertical PCB	AC7MPNZVB
			Bulk Pack	AC7MPNZB BULK



PRODUCT - FIGURE	DRAWING Dimensions in mm (inches)	DESCRIPTION	VARIATIONS	PART NUMBER
		XLR 7 pole male, Wide flange, Gold Plated Machined contacts, Nickel Finish	Standard	AC7MP
			Vertical PCB	AC7MPV
			Bulk Pack	AC7MP BULK
		XLR 7 pole male, Wide flange, Gold Plated Machined contacts, Black Finish	Standard	AC7MPB
			Vertical PCB	AC7MPBV
			Bulk Pack	AC7MPB BULK
		XLR 7 pole female, Wide flange, Gold Plated Machined contacts, Nickel Finish	Standard	AC7FPZ
			Vertical PCB	AC7FPZV
			Bulk Pack	AC7FPZ BULK
		XLR 7 pole female, Wide flange, Gold Plated Machined contacts, Black Finish	Standard	AC7FPZB
			Vertical PCB	AC7FPZVB
			Bulk Pack	AC7FPZB BULK

