

## GBC548

### NPN SILICON TRANSISTOR

#### Description

The GBC548 is designed for drive and output-stages of audio amplifiers.

#### Features

- High DC Current Gain: 110~800 @  $V_{CE}=5V$ ,  $I_C=2mA$
- Complementary to GBC558

#### Package Dimensions

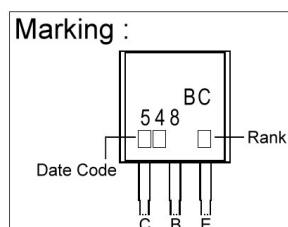
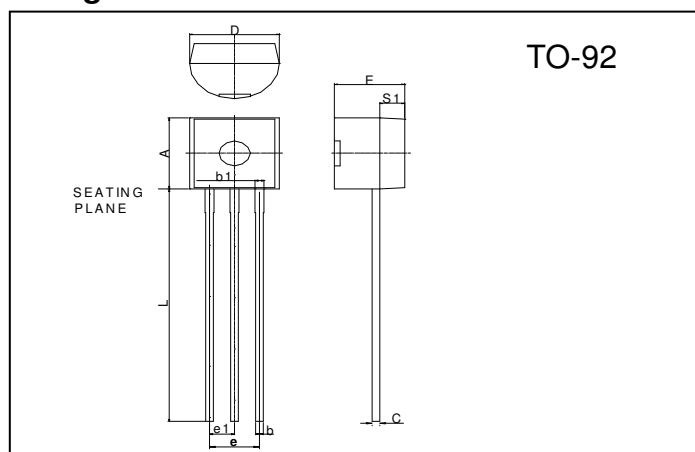

REF.	Millimeter		REF.	Millimeter	
	Min.	Max.		Min.	Max.
A	4.45	4.7	D	4.44	4.7
S1	1.02	-	E	3.30	3.81
b	0.36	0.51	L	12.70	-
b1	0.36	0.76	e1	1.150	1.390
C	0.36	0.51	e	2.42	2.66

#### Absolute Maximum Ratings ( $T_A=25^{\circ}C$ )

Parameter	Symbol	Ratings	Unit
Collector to Base Voltage	$V_{CBO}$	30	V
Collector to Emitter Voltage	$V_{CEO}$	30	V
Emitter to Base Voltage	$V_{EBO}$	6	V
Collector Current (continuous)	$I_C$	100	mA
Total Device Dissipation @ $T_A = 25^{\circ}C$	$P_D$	625	mW
Derate above $25^{\circ}C$		5.0	mW/ $^{\circ}C$
Total Device Dissipation @ $T_C = 25^{\circ}C$	$P_D$	1.5	W
Derate above $25^{\circ}C$		12	mW/ $^{\circ}C$
Operating and Storage Junction Temperature	$T_J, T_{stg}$	-55 ~ +150	$^{\circ}C$
Thermal Resistance, Junction to Ambient	$R_{\theta JA}$	200	$^{\circ}C/W$
Thermal Resistance, Junction to Case	$R_{\theta JC}$	83.3	$^{\circ}C/W$

#### Electrical Characteristics ( $T_A = 25^{\circ}C$ unless otherwise noted)

Symbol	Min.	Typ.	Max.	Unit	Test Conditions
$V_{CBO}$	30	-	-	V	$I_C=100\mu A, I_E=0$
$V_{CEO}$	30	-	-	V	$I_C=1mA, I_B=0$
$V_{EBO}$	6	-	-	V	$I_E=10\mu A, I_C=0$
$I_{CES}$	-	-	15	nA	$V_{CE}=35V, V_{BE}=0$
* $V_{CE(sat)1}$	-	0.09	0.25	V	$I_C=10mA, I_B=0.5mA$
* $V_{CE(sat)2}$	-	0.2	0.6	V	$I_C=100mA, I_B=5mA$
* $V_{BE(sat)}$	-	0.7	-	V	$I_C=10mA, I_B=0.5mA$
* $V_{BE(on)1}$	0.55	-	0.7	V	$V_{CE}=5V, I_C=2mA$
* $V_{BE(on)2}$	-	-	0.77	V	$V_{CE}=5V, I_C=10mA$
* $h_{FE}$	110	-	800		$V_{CE}=5V, I_C=2mA$
fT	150	300	-	MHz	$V_{CE}=5V, I_C=10mA, f=100MHz$
Cob	-	1.7	4.5	pF	$V_{CB}=10V, I_C=0, f=1MHz$

\*Pulse Test: Pulse Width  $\leq 380\mu s$ , Duty Cycle  $\leq 2\%$

#### Classification Of $h_{FE}$

Rank	A	B	C
Range	110 ~ 220	200 ~ 450	420 ~ 800

## Characteristics Curve

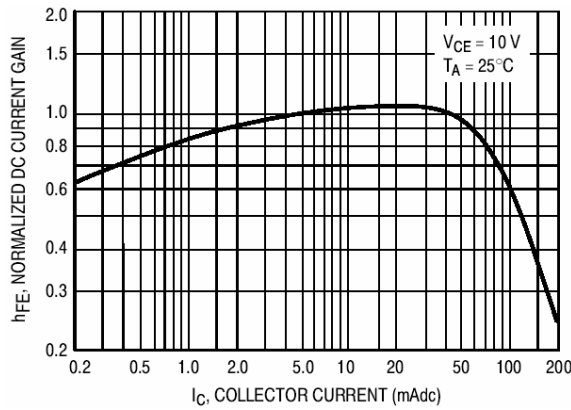

**Fig 1. DC Current Gain**

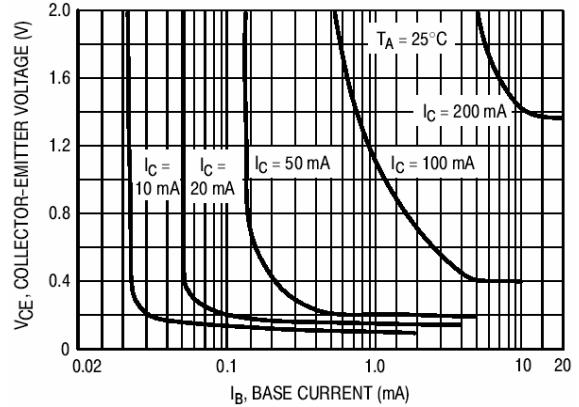

**Fig 2. Collector Saturation Region**

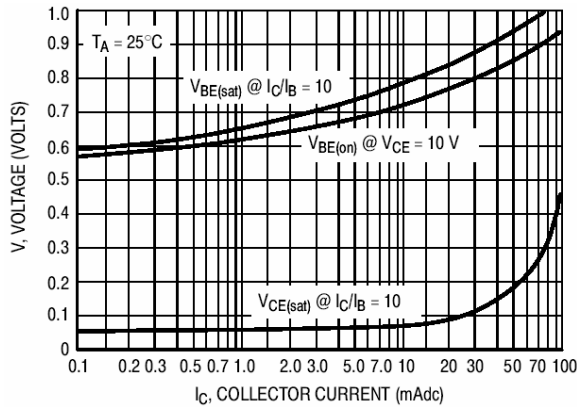

**Fig 3. "Saturation" & "On" Voltages**

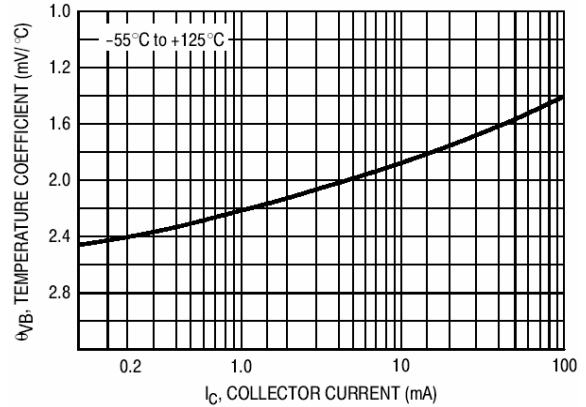

**Fig 4. Temperature Coefficients**

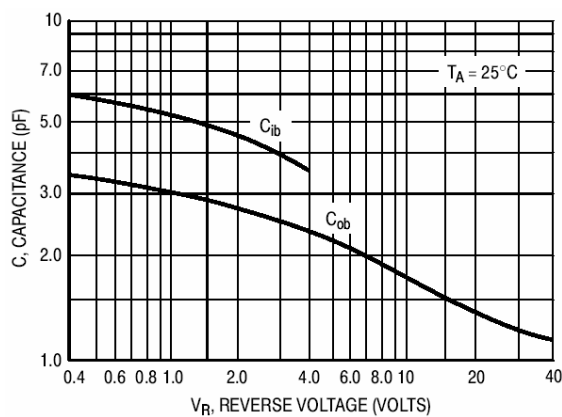

**Fig 5. Capacitances**

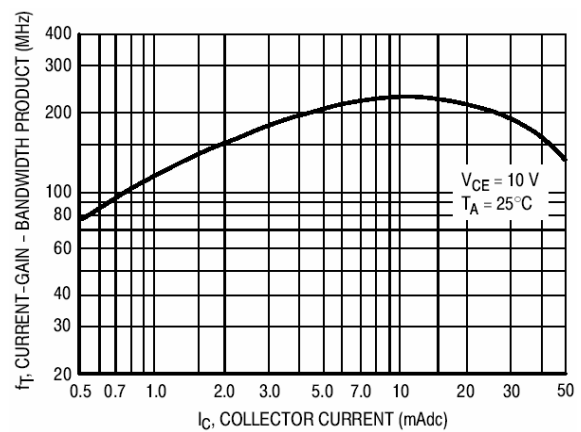

**Fig 6. Bandwidth Product**

**Important Notice:**

- All rights are reserved. Reproduction in whole or in part is prohibited without the prior written approval of GTM.
- GTM reserves the right to make changes to its products without notice.
- GTM semiconductor products are not warranted to be suitable for use in life-support Applications, or systems.
- GTM assumes no liability for any consequence of customer product design, infringement of patents, or application assistance.

**Head Office And Factory:**

- **Taiwan:** No. 17-1 Tatung Rd. Fu Kou Hsin-Chu Industrial Park, Hsin-Chu, Taiwan, R. O. C.
- TEL : 886-3-597-7061 FAX : 886-3-597-9220, 597-0785
- **China:** (201203) No.255, Jang-Jiang Tsai-Lueng RD. , Pu-Dung-Hsin District, Shang-Hai City, China
- TEL : 86-21-5895-7671 ~ 4 FAX : 86-21-38950165