

FEATURES

- No frequency Compensation Required
- No latch-up
- Large common mode and differential voltage range
- Parameter tracking over temperature range
- Gain and phase match between amplifiers
- Internally frequency compensated
- Low noise input transistors
- Moisture Sensitivity Level 3

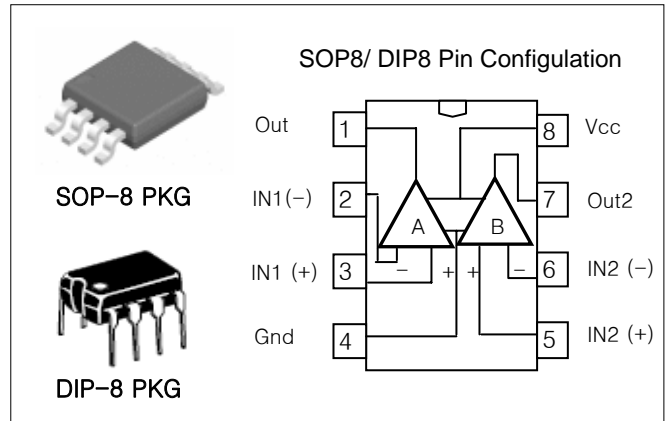

ORDERING INFORMATION

Device	Package
LM4558D	8 SOP
LM4558N	8 DIP

DESCRIPTIONS

The LM4558 devices is a monolithic integrated circuit designed for dual operational amplifier. The high common-mode input voltage range and the absence of latch-up make these amplifiers ideal for voltage-follower applications. The devices are short-circuit protected and the internal frequency compensation ensures stability without external components. The LM4558 is characterized for operation from 0°C TO 70°C.

SCHEMATIC (EACH AMPLIFIER)

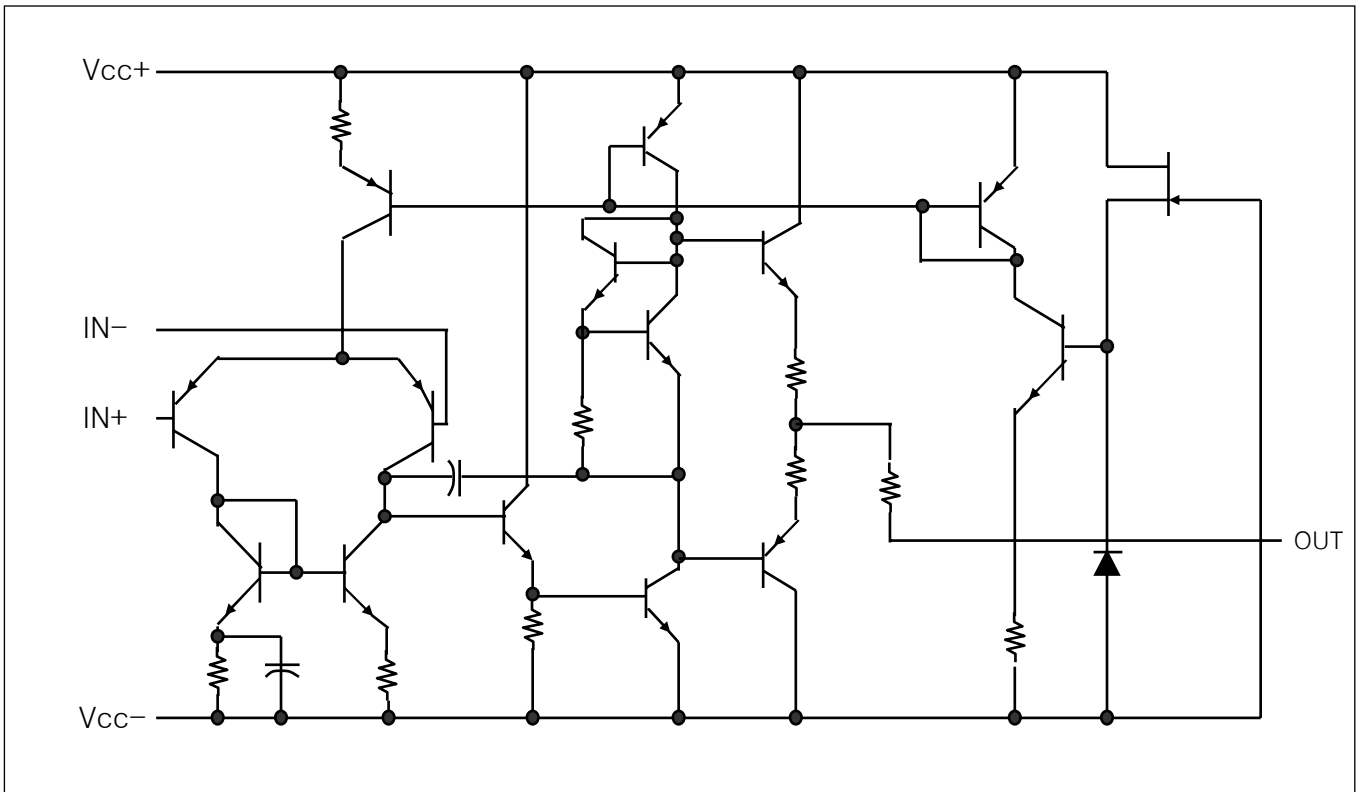

Absolute maximum ratings over operating free-air temperature range.

		LM4558	UNIT
Supply Voltage	V_{CC}	± 22	V
Differential Input Voltage	$V_{I(DIFF)}$	± 30	V
Input Voltage	V_I	± 15	V
Duration of output short circuit to ground, one amplifier at a time		Unlimited	
Short temperature range	T_{stg}	-65 to 150	°C

Recommended operating conditions

		MIN	MAX	UNIT
Supply voltage	V_{CC+}	5	15	V
	V_{CC-}	-5	-15	
Operating free-air temperature, T_A		LM4558 0	70	°C

Electrical characteristics at specified free-air temperature, $V_{CC}= 15V$ (unless otherwise noted)

PARAMETER	TEST CONDITIONS*		LM4558			UNIT
			MIN	TYP	MAX	
V_{IO} Input Offset Voltage	VO=0	25°C		0.5	5	mV
		Full Range			6	
V_{O1}/V_{O2} Crosstalk attenuation	Open	$R_S=100\ \Omega$ $f=1\text{ kHz}$	25°C		85	
	$A_{VD}=100$				100	
I_{IO} Input Offset Current	VO=0	25°C		5	200	nA
		Full Range			500	
r_i	Input resistance	25°C	0	5		M Ω
I_{IB} Input Bias Current	VO=0	25°C		140	500	nA
		Full Range			1500	
V_{ICR} Common-Mode Input Voltage range		25°C	± 12	± 14		V
VOM Maximum output voltage swing		$R_L = 10\text{ k}\Omega$	25°C	± 12	± 14	V
		$R_L = 2\text{ k}\Omega$	25°C	± 10	± 13	
		$R_L \geq 2\text{ k}\Omega$	Full Range	± 10		
A_{VD} Large-Signal Differential Voltage Amplification	$V_O=\pm 10V$ $R_L \geq 2\text{ k}\Omega$	25°C	50	350		V/mV
		Full Range	25			
CMRR Common-Mode Rejection Ratio	$V_{CC}=5V\text{ to MAX,}$ $V_{IC}=V_{ICR}\text{ MIN}$	25°C	65	80		dB
K_{SVS} Supply Voltage Sensitivity Ratio($\Delta V_{IO}/\Delta V_{CC}$)		25°C		30	150	$\mu V/V$
V_{O1}/V_{O2} Crosstalk Attenuation	$f=1\text{ kHz to }20\text{ kHz}$	25°C		120		dB
I_{CC} Supply Current (Both Amplifiers)	$V_O=0, \text{ No Load}$	25°C		2.5	5.6	mA
		$T_A(\text{min})$		3.0	6.6	
		$T_A(\text{max})$		2.0	5.0	

* All characteristics are measured under open-loop conditions with zero common-mode input voltage unless otherwise specified. Full range is 0°C to 70 °C. $T_A(\text{min}) = 0^\circ\text{C}$. $T_A(\text{max}) = 70^\circ\text{C}$.

TYPICAL PERFORMANCE CHARACTERISTICS

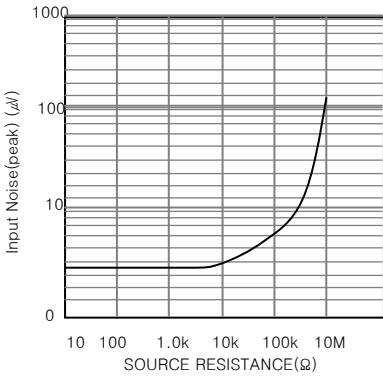

Figure 1. Burst Noise vs Source Resistance

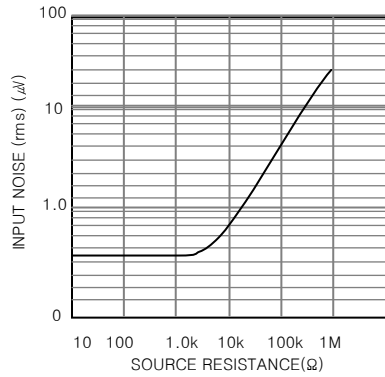

Figure 2. RMS Noise vs Source Resistance

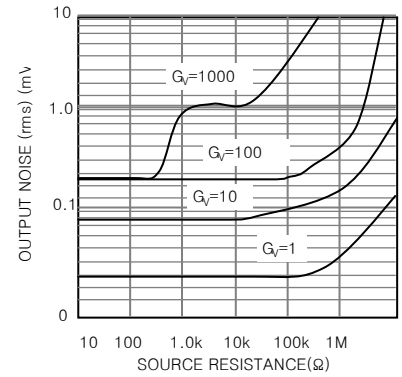

Figure 3. Output Noise vs Source Resistance

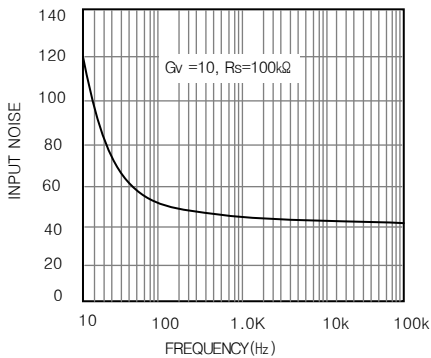

Figure 4. Spectral Noise Density

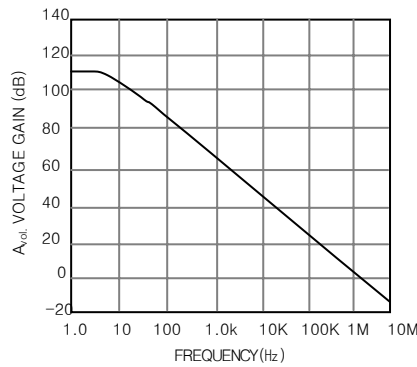

Figure 5. Open Loop Frequency Response

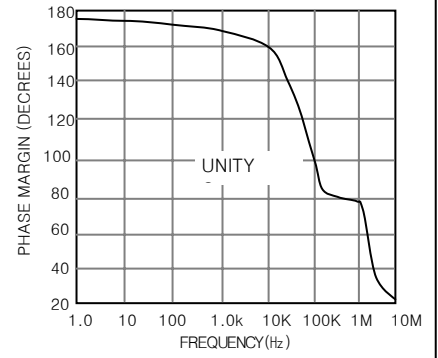

Figure 6. Phase Margin vs Frequency

OUTPUT CHARACTERISTICS
CURRENT SINKING

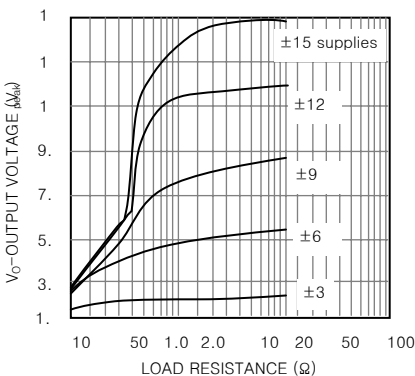

Figure 7. Positive Output Voltage Swing vs Load Resistance

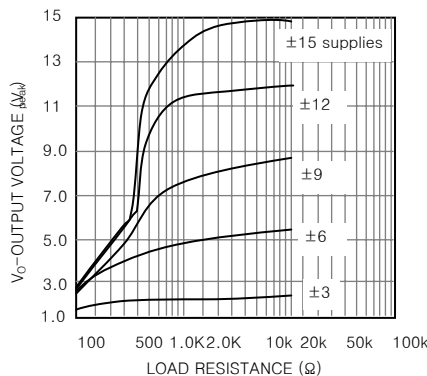

Figure 7. Negative Output Voltage Swing vs Load Resistance

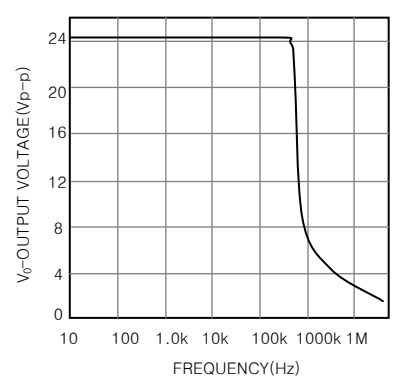

Figure 9. Power Bandwidth