

NPN Silicon RF Transistor

- Low current device suitable e.g. for handhelds
- For high frequency oscillators e.g. DRO for LNB
- For ISM band applications like Automatic Meter Reading, Sensors etc.
- Transit frequency $f_T = 25$ GHz
- Pb-free (RoHS compliant) package
- Qualified according AEC Q101

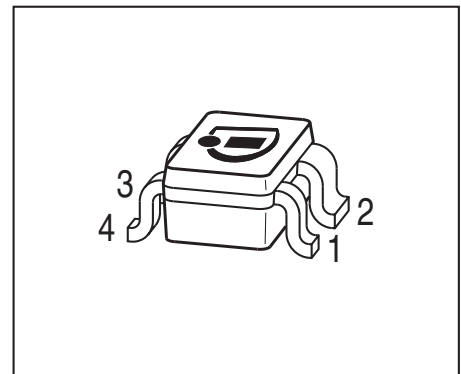

ESD (Electrostatic discharge) sensitive device, observe handling precaution!

Type	Marking	Pin Configuration						Package
BFP410	AKs	1=B	2=E	3=C	4=E	-	-	SOT343

Maximum Ratings at $T_A = 25$ °C, unless otherwise specified

Parameter	Symbol	Value	Unit
Collector-emitter voltage $T_A = 25$ °C $T_A = -55$ °C	V_{CEO}	4.5 4.1	V
Collector-emitter voltage	V_{CES}	13	
Collector-base voltage	V_{CBO}	13	
Emitter-base voltage	V_{EBO}	1.5	
Collector current	I_C	40	mA
Base current	I_B	6	
Total power dissipation ¹⁾ $T_S \leq 100$ °C	P_{tot}	150	mW
Junction temperature	T_J	150	°C
Ambient temperature	T_A	-55 ... 150	
Storage temperature	T_{Stg}	-55 ... 150	

¹⁾ T_S is measured on the emitter lead at the soldering point to the pcb

Thermal Resistance

Parameter	Symbol	Value	Unit
Junction - soldering point ¹⁾	R_{thJS}	335	K/W

Electrical Characteristics at $T_A = 25^\circ\text{C}$, unless otherwise specified

Parameter	Symbol	Values			Unit
		min.	typ.	max.	
DC Characteristics					
Collector-emitter breakdown voltage $I_C = 1\text{ mA}, I_B = 0$	$V_{(BR)CEO}$	4.5	5	-	V
Collector-emitter cutoff current $V_{CE} = 2\text{ V}, V_{BE} = 0$ $V_{CE} = 5\text{ V}, V_{BE} = 0, T_A = 85^\circ\text{C}$ (verified by random sampling)	I_{CES}	-	1	30	nA
		-	2	50	
Collector-base cutoff current $V_{CB} = 2\text{ V}, I_E = 0$	I_{CBO}	-	1	30	
Emitter-base cutoff current $V_{EB} = 0.5\text{ V}, I_C = 0$	I_{EBO}	-	0.001	0.6	μA
DC current gain $I_C = 13\text{ mA}, V_{CE} = 2\text{ V}$, pulse measured	h_{FE}	60	95	130	-

¹For calculation of R_{thJA} please refer to Application Note Thermal Resistance

Electrical Characteristics at $T_A = 25^\circ\text{C}$, unless otherwise specified

Parameter	Symbol	Values			Unit
		min.	typ.	max.	
AC Characteristics (verified by random sampling)					
Transition frequency $I_C = 20\text{ mA}$, $V_{CE} = 2\text{ V}$, $f = 2\text{ GHz}$	f_T	18	25	-	GHz
Collector-base capacitance $V_{CB} = 2\text{ V}$, $f = 1\text{ MHz}$, $V_{BE} = 0$, emitter grounded	C_{cb}	-	0.09	0.17	pF
Collector emitter capacitance $V_{CE} = 2\text{ V}$, $f = 1\text{ MHz}$, $V_{BE} = 0$, base grounded	C_{ce}	-	0.35	-	
Emitter-base capacitance $V_{EB} = 0.5\text{ V}$, $f = 1\text{ MHz}$, $V_{CB} = 0$, collector grounded	C_{eb}	-	0.45	-	
Noise figure $I_C = 2\text{ mA}$, $V_{CE} = 2\text{ V}$, $f = 2\text{ GHz}$, $Z_S = Z_{Sopt}$	F	-	1.2	-	dB
Power gain, maximum stable ¹⁾ $I_C = 20\text{ mA}$, $V_{CE} = 2\text{ V}$, $Z_S = Z_{Sopt}$, $Z_L = Z_{Lopt}$, $f = 2\text{ GHz}$	G_{ms}	-	21.5	-	dB
Insertion power gain $V_{CE} = 2\text{ V}$, $I_C = 20\text{ mA}$, $f = 2\text{ GHz}$, $Z_S = Z_L = 50\ \Omega$	$ S_{21} ^2$	-	18.5	-	
Third order intercept point at output ²⁾ $V_{CE} = 2\text{ V}$, $I_C = 20\text{ mA}$, $f = 2\text{ GHz}$, $Z_S = Z_L = 50\ \Omega$	IP_3	-	23.5	-	dBm
1dB Compression point at output $I_C = 20\text{ mA}$, $V_{CE} = 2\text{ V}$, $Z_S = Z_L = 50\ \Omega$, $f = 2\text{ GHz}$	P_{-1dB}	-	10.5	-	

¹⁾ $G_{ms} = |S_{21} / S_{12}|$

²⁾ IP_3 value depends on termination of all intermodulation frequency components.
Termination used for this measurement is $50\ \Omega$ from 0.1 MHz to 6 GHz

Total power dissipation $P_{tot} = f(T_S)$

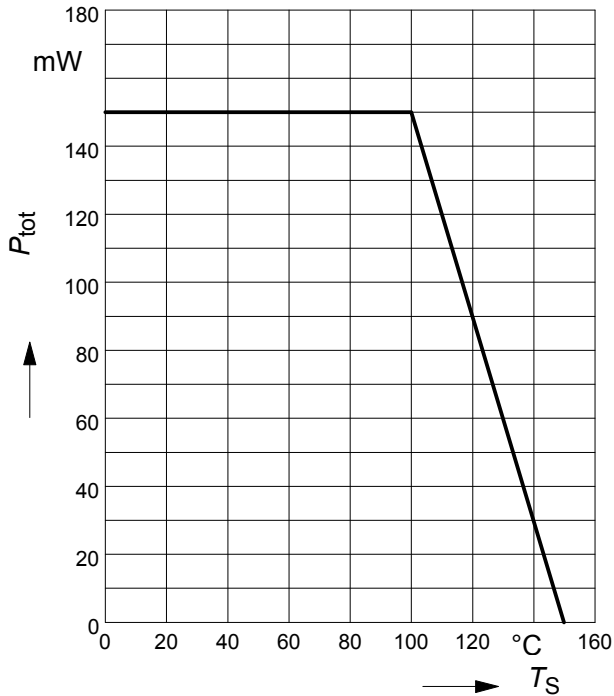

**Collector-base capacitance $C_{cb} = f(V_{CB})$
 $f = 1\text{ MHz}$**

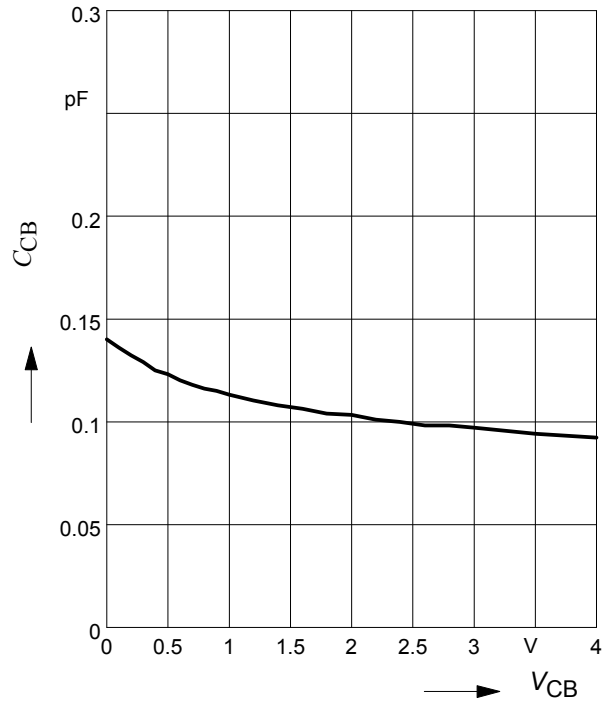

Transition frequency $f_T = f(I_C)$

$f = 2\text{ GHz}$

$V_{CE} = \text{parameter in V}$

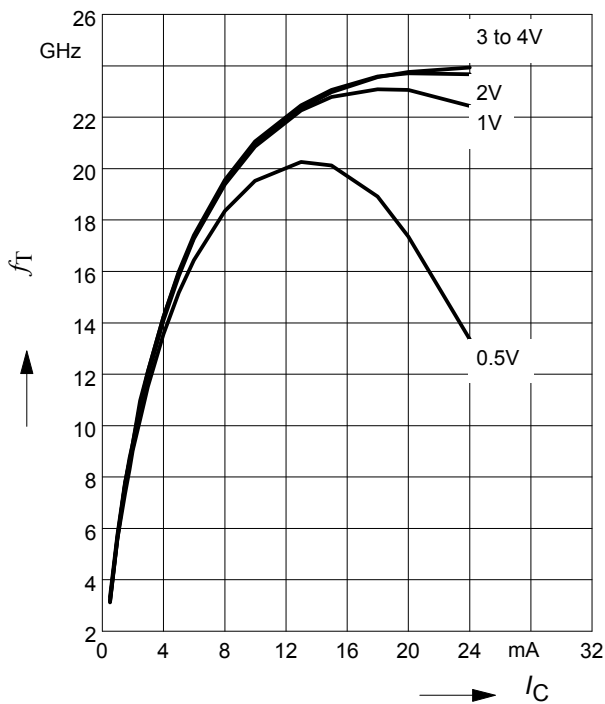

Power gain $G_{ma}, G_{ms}, |S_{21}|^2 = f(f)$

$V_{CE} = 2\text{ V}, I_C = 13\text{ mA}$

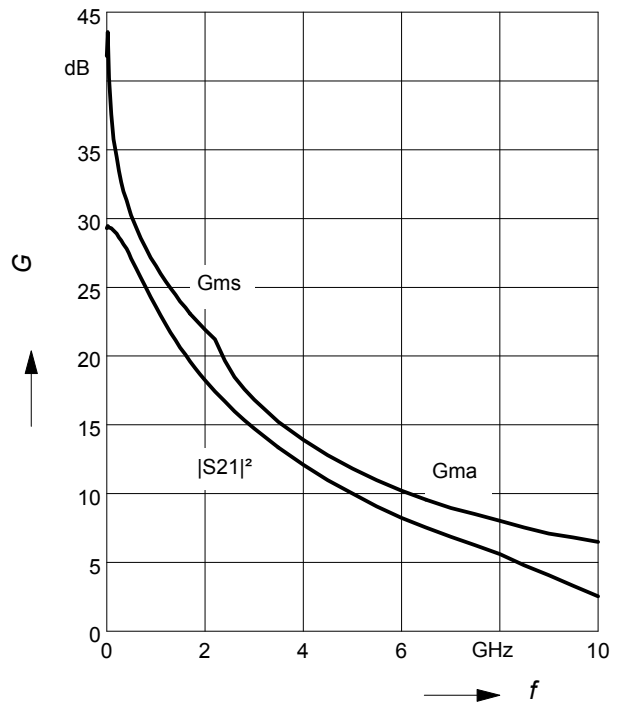

Power gain $G_{ma}, G_{ms} = f(I_C)$

$V_{CE} = 2V$

$f =$ parameter in GHz

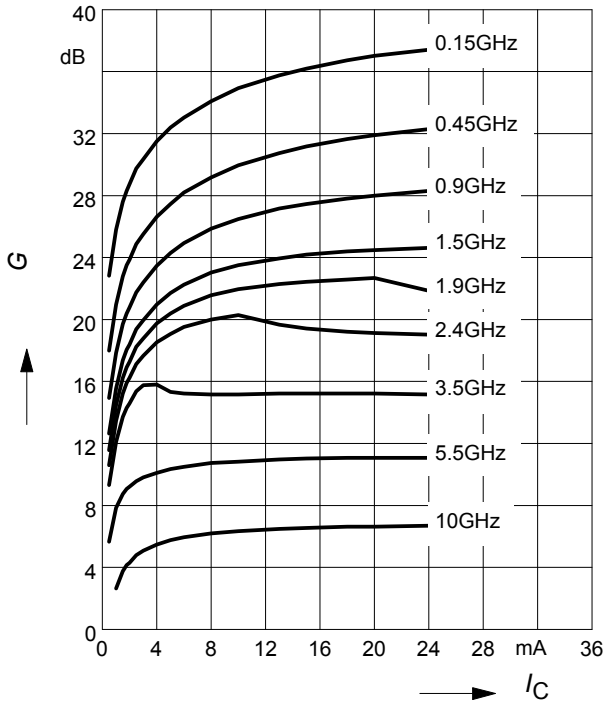

Power gain $G_{ma}, G_{ms} = f(V_{CE})$

$I_C = 13\text{ mA}$

$f =$ parameter in GHz

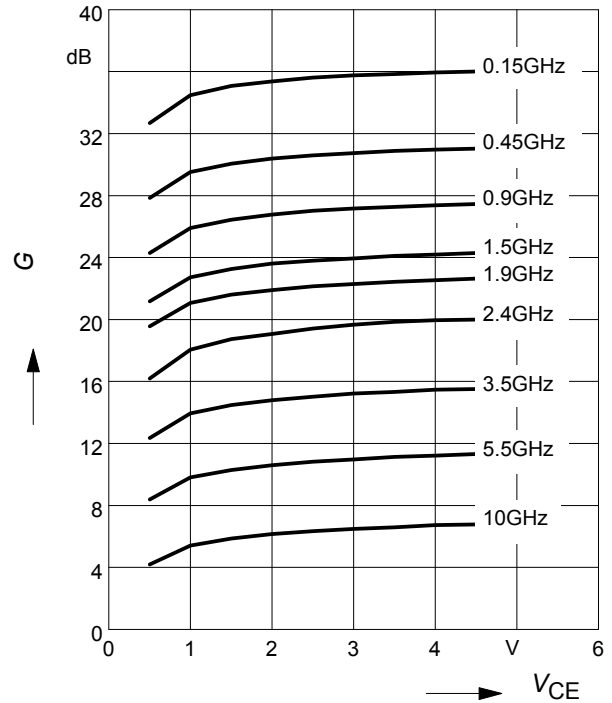

Noise figure $F = f(I_C)$

$V_{CE} = 2\text{ V}, Z_S = Z_{Sopt}$

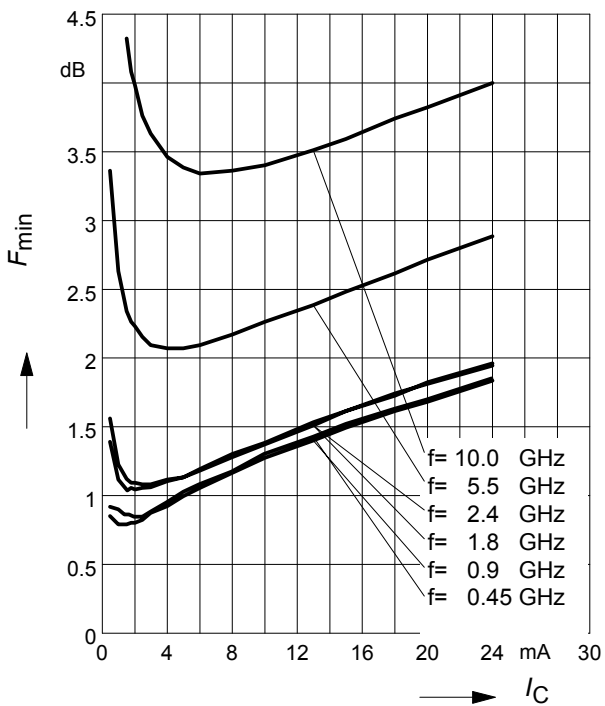

Noise figure $F = f(I_C)$

$V_{CE} = 2\text{ V}, f = 2\text{ GHz}$

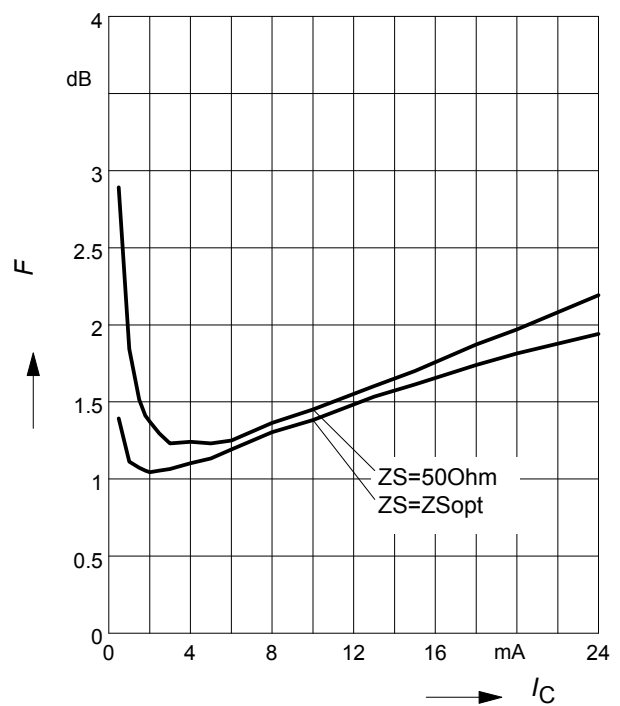

Collector current $I_C = f(V_{BE})$

$V_{CE} = 2\text{ V}$

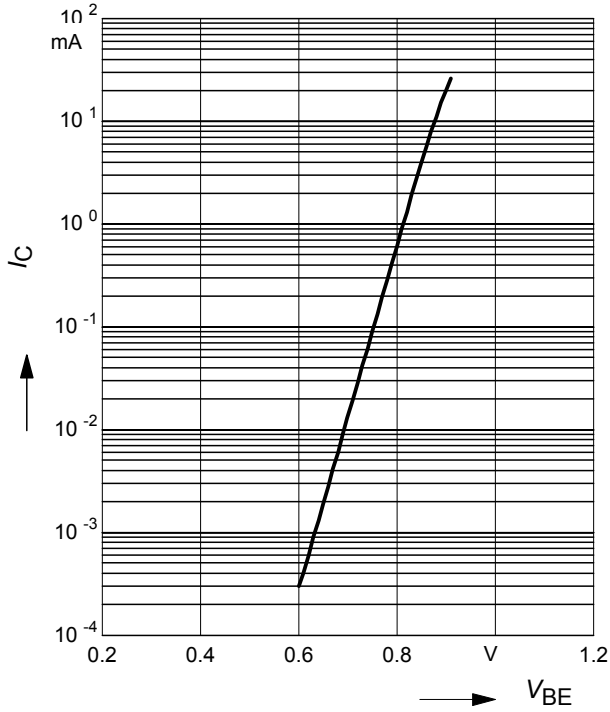

Collector current $I_C = f(V_{CE})$

Parameter I_B

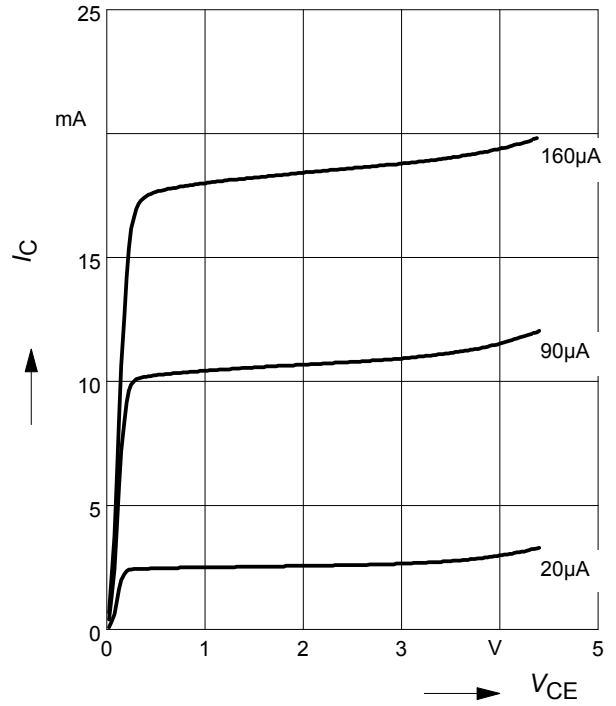

DC current gain $h_{FE} = f(I_C)$

$V_{CE} = 2\text{ V}$

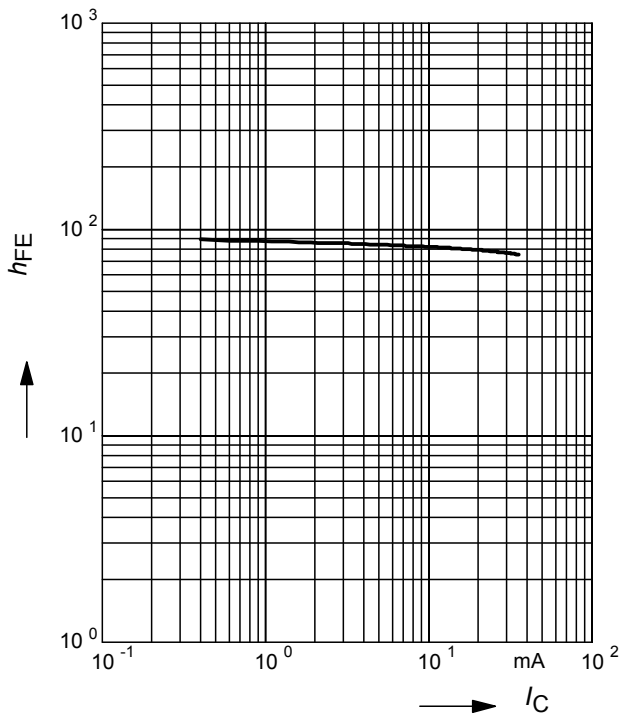

Base current reverse $I_B = f(V_{EB})$

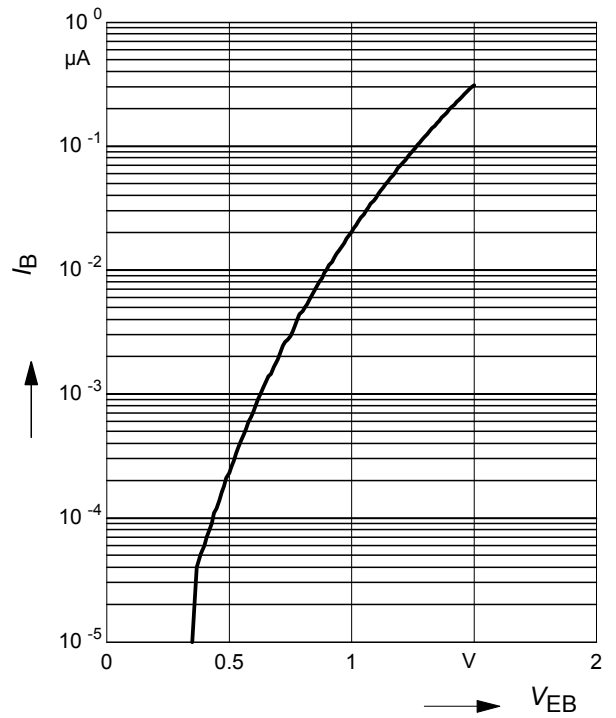

Package Outline

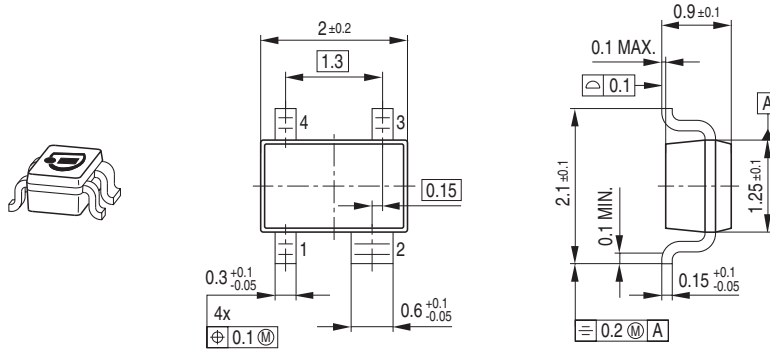

Foot Print

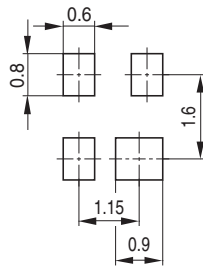

Marking Layout (Example)

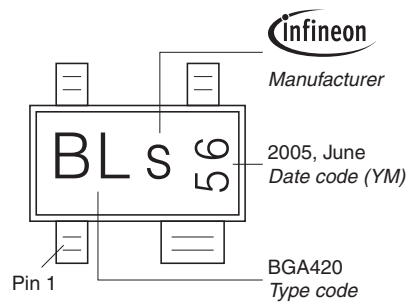

Standard Packing

Reel ø180 mm = 3.000 Pieces/Reel
 Reel ø330 mm = 10.000 Pieces/Reel

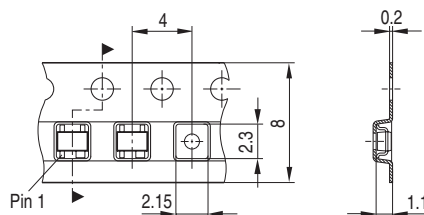

Edition 2009-11-16

**Published by
Infineon Technologies AG
81726 Munich, Germany**

**© 2009 Infineon Technologies AG
All Rights Reserved.**

Legal Disclaimer

The information given in this document shall in no event be regarded as a guarantee of conditions or characteristics. With respect to any examples or hints given herein, any typical values stated herein and/or any information regarding the application of the device, Infineon Technologies hereby disclaims any and all warranties and liabilities of any kind, including without limitation, warranties of non-infringement of intellectual property rights of any third party.

Information

For further information on technology, delivery terms and conditions and prices, please contact the nearest Infineon Technologies Office (www.infineon.com).

Warnings

Due to technical requirements, components may contain dangerous substances. For information on the types in question, please contact the nearest Infineon Technologies Office.

Infineon Technologies components may be used in life-support devices or systems only with the express written approval of Infineon Technologies, if a failure of such components can reasonably be expected to cause the failure of that life-support device or system or to affect the safety or effectiveness of that device or system. Life support devices or systems are intended to be implanted in the human body or to support and/or maintain and sustain and/or protect human life. If they fail, it is reasonable to assume that the health of the user or other persons may be endangered.