

SKiIP 312 GDL 120 - 404 WT (E/U)

Absolute Maximum Ratings		Values	Units
Symbol	Conditions ¹⁾		
IGBT & Inverse Diode			
V _{CES}		1200	V
V _{CC} ¹⁰⁾	Operating DC link voltage	900	V
I _C	T _{heatsink} = 25 °C	300	A
I _{CM}	T _{heatsink} = 25 °C; t _p < 1 ms	600	A
T _J ³⁾	IGBT & Diode	-55 ... +150	°C
V _{isot} ⁴⁾	AC, 1 min.	3000 ⁵⁾	V
I _F	T _{heatsink} = 25 °C	240	A
I _{FM}	T _{heatsink} = 25 °C; t _p < 1 ms	600	A
I _{FSM}	t _p = 10 ms; sin.; T _J = 150 °C	2160	A
I _t ²⁾ (Diode)	t _p = 10 ms; T _J = 150 °C	23,4	kA ² s
Driver - inverter			
V _{S1}	Stabilized power supply	18	V
V _{S2} ¹⁰⁾	Nonstabilized power supply	30	V
dv/dt	Primary to second. side	75	kV/μs
T _{op} , T _{stg}	Operating / stor. temperature	-25 ... +85	°C

Characteristics					
Symbol	Conditions ¹⁾	min.	typ.	max.	Units
V _{(BR)CES}	Driver without power supply	≥ V _{CES}	-	-	V
I _{CES}	V _{GE} = 0 } T _J = 25 °C	-	0,3	-	mA
	V _{CE} = V _{CES} } T _J = 125 °C	-	15	-	mA
V _{CEsat} ⁸⁾	I _C = 225 A T _J = 25 (125) °C	-	2,75 (3,6)	-	V
V _{CEsat} ⁸⁾	I _C = 300 A T _J = 25 (125) °C	-	3,15 (4,2)	-	V
I _{CETRIP}	T _J = 125 °C; V _s = 15 V ± 0,6V	≥ 375	-	-	A
C _{CHC}	per SKiIPACK AC side	-	0,8	-	nF
L _{CE}	Top (Bottom)	-	15	-	nH
t _{d(on)}	V _{CC} = 600 V I _C = 300 A T _J = 125 °C inductive load	-	150	-	ns
t _{d(on)Driver}		-	1,2	-	μs
t _r		-	100	-	ns
t _{d(off)}		-	0,7	-	μs
t _{d(off)Driver}		-	1,2	-	μs
t _f		-	80	-	ns
E _{on} + E _{off}		-	90	-	mJ
Inverse Diode ²⁾ - inverter					
V _F ⁸⁾ = V _{EC}	I _F = 225 A T _J = 25 (125) °C	-	2,0(1,8)	-	V
	I _F = 300 A T _J = 25 (125) °C	-	2,25(2,05)	-	V
V _{TO}	T _J = 125 °C	-	1,0	-	V
r _T	T _J = 125 °C	-	4,0	-	mΩ
E _{on} + E _{off}	I _F = 300 A; T _J = 125 °C	-	12	-	mJ
Diode ²⁾ - brake chopper (BC)					
V _F ⁸⁾ = V _{EC}	I _F = 150 A T _J = 25 (125) °C	-	2,0(1,8)	-	V
	I _F = 200 A T _J = 25 (125) °C	-	2,25(2,05)	-	V
V _{TO}	T _J = 125 °C	-	1,0	-	V
r _T	T _J = 125 °C	-	6,0	-	mΩ
Thermal Characteristics					
R _{thjh}	per IGBT	-	0,08	-	K/W
R _{thjd}	per diode inverter (BC)	-	0,27(0,4)	-	K/W
T _{tp} ¹¹⁾	Over temperature protection	109	115	121	°C
R _{thha} ⁶⁾	P16/360 F; V _{air} = 297 m ³ / h	-	0,036	-	K/W
Mechanical Data					
M _{dc}	for DC terminals, SI Units	4	-	6	Nm
M _{ac}	for AC terminals, SI Units	8	-	10	Nm
Case			S5		

SKiIPACK® SK integrated Intelligent Power PACK 3-phase bridge with brake chopper

SKiIP 312 GDL 120 + Driver 404 WT (E/U)⁷⁾

Case S5

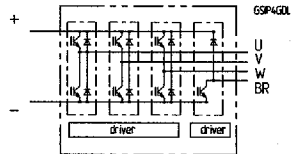
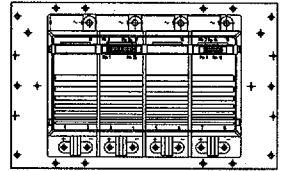

Features

- Low thermal impedance
- Optimal thermal management with integrated heatsink
- Pressure contact technology with increased power cycling capability, compact design
- Low stray inductance
- High power, small losses
- Overtemp. protection
- Short circuit protection
- Isolated power supply

- 1) T_{heatsink} = 25 °C, unless otherwise specified
- 2) CAL = Controlled Axial Lifetime Technology (soft and fast)
- 3) without driver
- 4) Driver input to DC link/AC output or DC link/AC output to heatsink
- 5) 3,5 kV (AC; on request)
- 6) other heatsink on request
- 7) W - Driver wire input
T - Temperature protection
E/U-voltage levels V_{DC} br. chopper
- 8) Chip voltage drop
- 9) 24 V supply voltage selective
- 10) with SK-DC link (low inductance)
- 11) thermal reference for R_{thjh}; R_{thha}

SKIIPACK®
SK integrated
Intelligent Power PACK
3-phase bridge with
brake chopper
SKIIP 312 GDL 120
+ Driver 404 WT (E/U)³⁾

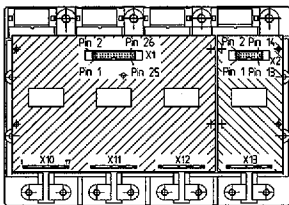

SKIIP 312 GDL 120 - 404 WT (E/U)
Driver for 3-phase bridge and brake chopper

Absolute Maximum Ratings		3-phase bridge	brake chopper	Units	remark
Symbol	Conditions	Values			
V _{S1}	supply voltage primary	18		V	
V _{S2} ¹⁾	supply voltage primary	30		V	
I _{outmax}	output peak current max.	± 10	± 1,5	A	
I _{outAV}	output average current	± 50	± 90	A	
f _{swmax}	switching frequency max.	12	5	kHz	
V _{CE}	collector emitter voltage sense across IGBT	1200		V	
dv/dt	rate of rise and fall of voltage (secondary to primary side)	75	50	kv/μs	
V _{isol IO} ⁴⁾	Isol. test volt. IN/OUT (RMS; 1 min)	2,5		kv~	
V _{isol 12}	Isol. test volt. OUT1 - OUT2	1,5		kv=	
T _{op} , T _{stg}	operating / stor. temperature	-25...+85		°C	

Characteristics		Values		Units	remark
Symbol	Conditions				
V _{S1}	supply voltage primary	15,0 ± 4%		V	
V _{S2} ¹⁾	supply voltage primary	24,0		V	+25%/ -15%
V _{uvs}	supply undervolt. monitoring	13		V	
V _{uvs} ¹⁾	supply undervolt. monitoring	19,5	16	V	
I _{S01}	sup. current pr.side (standby)	380	67	mA	
I _{S02} ¹⁾	sup. current pr.side (standby)	300	67	mA	
I _{S1}	sup. current pr.side (max)	900	77	mA	
I _{S2} ¹⁾	sup. current pr.side (max)	700	77	mA	
V _{IT+}	input thresh. volt. (high) min	12,9		V	
V _{IT-}	input thresh. volt. (low) max.	2,1		V	
V _{GE(on)}	turn-on output gate voltage	15	15	V	
V _{GE(off)}	turn-off output gate voltage	- 8	0	V	
t _{d(on)}	propagation delay time on	1,2	< 20	μs	typ.
t _{d(off)}	propagation delay time off	1,2	< 25	μs	typ.
t _{TD}	dead time of interlock	3		μs	typ.
V _{CEstat}	V _{CE} -thresh. st. monitoring	5,1	5	V	typ.
V _{CEdyn}	V _{CE} -thresh. dyn. monitoring	9,5	10	V	typ.
V _{ol} ²⁾	logic low output voltage	< 0,5		V	15mA sink 2,5mA sink
V _{OH} ²⁾	logic high output voltage	max.30		V	
V _{RESET L}	Input voltage RESET Low	< 2		V	
V _{RESET H}	Input voltage RESET High	> 12		V	
V _{IL}	logic low input volt. Chop. ext. ON	< 5		V	> 5 mA
V _{IH}	logic high input volt. Chop.ext. ON	> 11,5		V	< 1 mA
t _{pdon-error}	propag. delay time-on error	6	< 60	μs	
t _{p RESET}	min. pulse width error memory RESET	5		μs	
T _{err}	max. temperature	115 ± 6		°C	
I _{AQmax}	max. output current	± 5		mA	pin 20

Voltage levels V _{DC} brake ⁵⁾		Values		Units	remark
Symbol	Conditions				
V _{DCmax}	DC-link voltage (max)		730	V	E
			860	V	U
V _{DCON}	Chopper voltage ON		681	V	E
			802	V	U
V _{DCOFF}	Chopper voltage OFF		667	V	E
			786	V	U

Features

3-phase bridge

- CMOS compatible inputs
- Short circuit protection by V_{CE} monitoring and soft switch off
- Drive interlock top/bottom
- Isolation by transformers
- Supply undervoltage protection
- Overtemperature protection

Features

brake chopper

- Short circuit protection by V_{CE} monitoring and soft switch off
- Self controlled switching
- Supply undervoltage protection
- Overtemperature protection

1) 24 V - supply voltage selective

2) Open collector output external pull-up resistor necessary

3) W - Driver wire input
T - Temperature protection

E/U-voltage levels V_{DC} br. chopper
E - EUROPE (400 V_{RMS})
U - USA (460 V_{RMS})

4) 3,5 kV_{AC} (on request)

5) other levels (on request)

CASES4

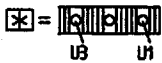
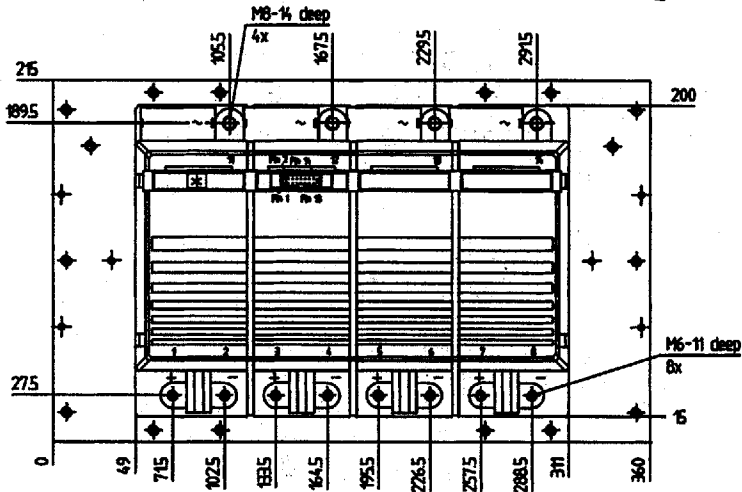
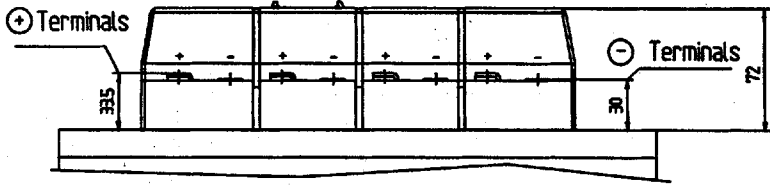

Version SKiIP ... GB ... FT (Fibreoptic input)

Case S5

SKIIPACK 4 - GDL

CASES5

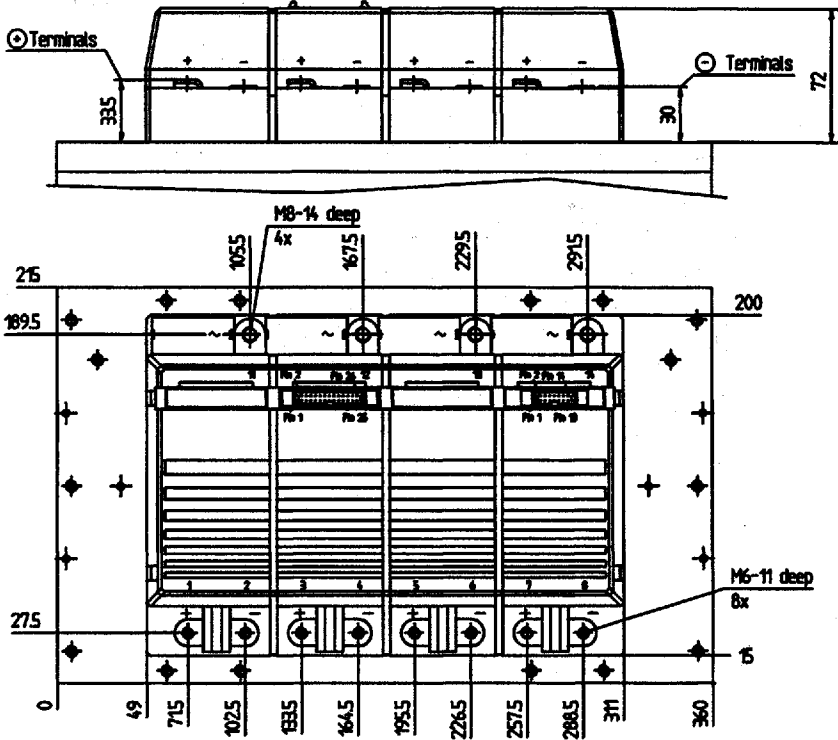

SKIIPACK view from right

