

Frequency Synthesizer

DSN-2100A+

50Ω 1230 to 2100 MHz

The Big Deal

- Fractional N synthesizer
- Low phase noise and spurious
- Wide bandwidth

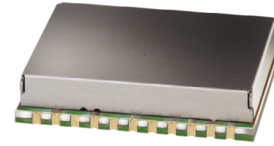

CASE STYLE: KL1294

Product Overview

The DSN-2100A+ is a Frequency Synthesizer, designed to operate from 1230 to 2100 MHz for Digital TV distribution application. The DSN-2100A+ is packaged in a metal case (size of 1.250" x 1.000" x 0.232") to shield against unwanted signals and noise.

Key Features

Feature	Advantages
Low phase noise and spurious: <ul style="list-style-type: none">• Phase Noise: -97 dBc/Hz typ. @ 10 kHz offset• Step Size Spurious: -92 dBc typ.• Comparison Spurious: -85 dBc typ.• Reference Spurious: -88 dBc typ.	Low phase noise and spurious improve system EVM (Error Vector Magnitude).
Robust design and construction	To enhance the robustness of DSN-2100A+, each internal component is secured to the substrate with chip bonder, thereby eliminating the risk of tombstoning during subsequent solder reflow operations by the customer.



IF/RF MICROWAVE COMPONENTS • ISO 9001 ISO 14001 AS9100 CERTIFIED RoHS compliant
P.O. Box 350166, Brooklyn, New York 11235-0003 (718) 934-4500 Fax (718) 332-4661



The Design Engineers Search Engine finds the model you need, Instantly • For detailed performance specs & shopping online see



Notes: 1. Performance and quality attributes and conditions not expressly stated in this specification sheet are intended to be excluded and do not form a part of this specification sheet. 2. Electrical specifications and performance data contained herein are based on Mini-Circuit's applicable established test performance criteria and measurement instructions. 3. The parts covered by this specification sheet are subject to Mini-Circuits standard limited warranty and terms and conditions (collectively, "Standard Terms"); Purchasers of this part are entitled to the rights and benefits contained therein. For a full statement of the Standard Terms and the exclusive rights and remedies thereunder, please visit Mini-Circuits' website at www.minicircuits.com/MCLStore/terms.jsp.

50Ω 1230 to 2100 MHz

Features

- Fractional N synthesizer
- Integrated VCO + PLL
- Low phase noise and spurious
- Robust design and construction
- Operating voltage (VCC VCO=+10V, VCC PLL=+18V)
- Wide bandwidth

Applications

- Digital TV distribution

General Description

The DSN-2100A+ is a Frequency Synthesizer, designed to operate from 1230 to 2100 MHz for Digital TV distribution application. The DSN-2100A+ is packaged in a metal case (size of 1.250" x 1.000" x 0.232") to shield against unwanted signals and noise. To enhance the robustness of DSN-2100A+, each internal component is secured to the substrate with chip bonder, thereby eliminating the risk of tombstoning during subsequent solder reflow operations by the customer.

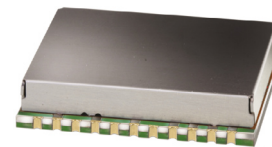

CASE STYLE: KL1294
PRICE: \$41.95 ea. QTY (1-9)

+ RoHS compliant in accordance with EU Directive (2002/95/EC)

The +Suffix has been added in order to identify RoHS Compliance. See our web site for RoHS Compliance methodologies and qualifications.

Simplified Schematic

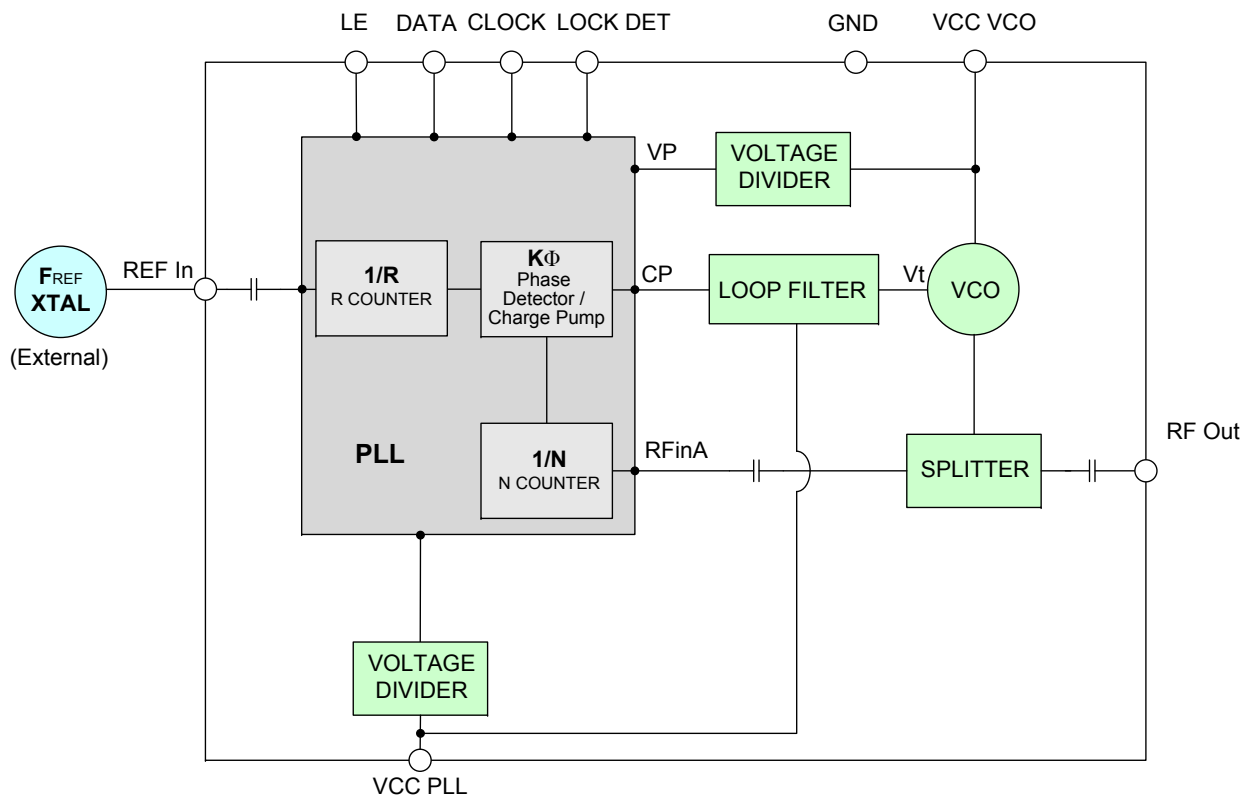

Mini-Circuits®

IF/RF MICROWAVE COMPONENTS • ISO 9001 ISO 14001 AS9100 CERTIFIED RoHS compliant

P.O. Box 350166, Brooklyn, New York 11235-0003 (718) 934-4500 Fax (718) 332-4661



The Design Engineers Search Engine finds the model you need, Instantly • For detailed performance specs & shopping online see

minicircuits.com

Notes: 1. Performance and quality attributes and conditions not expressly stated in this specification sheet are intended to be excluded and do not form a part of this specification sheet. 2. Electrical specifications and performance data contained herein are based on Mini-Circuit's applicable established test performance criteria and measurement instructions. 3. The parts covered by this specification sheet are subject to Mini-Circuits standard limited warranty and terms and conditions (collectively, "Standard Terms"); Purchasers of this part are entitled to the rights and benefits contained therein. For a full statement of the Standard Terms and the exclusive rights and remedies thereunder, please visit Mini-Circuits' website at www.minicircuits.com/MCLStore/terms.jsp.

REV. A
M127864
EDR-9534/1F1
DSN-2100A+
Category-E7
RAV
100630
Page 2 of 13

Electrical Specifications (over operating temperature -10°C to +60°C)

Parameters	Test Conditions	Min.	Typ.	Max.	Units
Frequency Range	-	1230	-	2100	MHz
Step Size	-	-	2	-	MHz
Comparison Frequency	-	-	20	-	MHz
Settling Time	Within ± 1 kHz	-	15	-	mSec
Output Power	-	0	+3	+6	dBm
SSB Phase Noise	@ 100 Hz offset	-	-90	-	dBc/Hz
	@ 1 kHz offset	-	-95	-91	
	@ 10 kHz offset	-	-97	-94	
	@ 100 kHz offset	-	-115	-111	
	@ 1 MHz offset	-	-141	-136	
Integrated SSB Phase Noise	@100 Hz to 1MHz	-	-51	-	dBc
Step Size Spurious Suppression	Step Size 2 MHz	-	-92	-74	dBc
0.5 Step Size Spurious Suppression	0.5 Step Size 1 MHz	-	-92	-74	
Reference Spurious Suppression	Ref. Freq. 10 MHz	-	-88	-70	
Comparison Spurious Suppression	Comp. Freq. 20 MHz	-	-85	-70	
Non - Harmonic Spurious Suppression	-	-	-90	-	
Harmonic Suppression	-	-	-42	-18	
VCO Supply Voltage	+10.00	+9.75	+10.00	+10.25	V
PLL Supply Voltage	+18.00	+17.75	+18.00	+18.25	
VCO Supply Current	-	-	50	56	mA
PLL Supply Current	-	-	24	33	
Reference Input (External)	Frequency	10 (square wave)	-	10	MHz
	Amplitude	1	-	1	V _{P-P}
	Input impedance	-	-	100	KΩ
	Phase Noise @ 100 Hz offset	-	-	-145	dBc/Hz
RF Output port Impedance	-	-	50	-	Ω
Input Logic Level	Input high voltage	-	2.4	-	V
	Input low voltage	-	-	0.6	V
Digital Lock Detect	Locked	-	2.4	3.3	V
	Unlocked	-	-	0.4	V
Frequency Synthesizer PLL	-	ADF4153			
PLL Programming	-	3-wire serial 3V CMOS			
Register Map @ 2100 MHz	R0_Register	-	(MSB) 11010010000000000000 (LSB)		
	R1_Register *	-	(MSB) 10P000100000000101001 (LSB)		
	R2_Register *	-	(MSB) 10XYZ0100010 (LSB)		
	R3_Register	-	(MSB) 1111000111 (LSB)		

*** Refer to Charge Pump Settings**

FREQ.LOCK [MHz]	Charge Pump Settings			
	P	X	Y	Z
1230 - 1400	0	0	1	1
1402 - 1800	0	1	0	0
1802 - 1820	0	1	0	1
1822 - 1950	1	1	0	1
1952 - 2050	1	1	1	0
2052 - 2100	1	1	1	1

Absolute Maximum Ratings

Parameters	Ratings
VCO Supply Voltage	10.7V
PLL Supply Voltage	19.5V
VCO Supply Voltage to PLL Supply Voltage	N.A
Reference Frequency Voltage	-0.3Vmin, +3.6Vmax
Data, Clock, LE Levels	-0.3Vmin, +3.6Vmax
Operating Temperature	-40°C to +85°C
Storage Temperature	-55°C to +100°C

Permanent damage may occur if any of these limits are exceeded



IF/RF MICROWAVE COMPONENTS • ISO 9001 ISO 14001 AS9100 CERTIFIED RoHS compliant
P.O. Box 350166, Brooklyn, New York 11235-0003 (718) 934-4500 Fax (718) 332-4661

The Design Engineers Search Engine finds the model you need, Instantly • For detailed performance specs & shopping online see



Notes: 1. Performance and quality attributes and conditions not expressly stated in this specification sheet are intended to be excluded and do not form a part of this specification sheet. 2. Electrical specifications and performance data contained herein are based on Mini-Circuit's applicable established test performance criteria and measurement instructions. 3. The parts covered by this specification sheet are subject to Mini-Circuits standard limited warranty and terms and conditions (collectively, "Standard Terms"); Purchasers of this part are entitled to the rights and benefits contained therein. For a full statement of the Standard Terms and the exclusive rights and remedies thereunder, please visit Mini-Circuits' website at www.minicircuits.com/MCLStore/terms.jsp.

Typical Performance Data

FREQUENCY (MHz)	POWER OUTPUT (dBm)			VCO CURRENT (mA)			PLL CURRENT (mA)		
	-15°C	+25°C	+65°C	-15°C	+25°C	+65°C	-15°C	+25°C	+65°C
	1230	3.02	3.00	2.84	49.19	49.75	50.31	23.39	24.90
1292	3.04	3.02	2.86	49.30	49.84	50.40	23.52	25.06	26.93
1384	3.16	3.13	2.97	49.43	49.96	50.50	23.09	24.49	26.36
1476	2.99	2.98	2.82	49.63	50.16	50.69	23.13	24.67	26.56
1568	2.90	2.89	2.75	49.67	50.20	50.73	23.48	25.04	26.97
1660	2.65	2.65	2.52	49.69	50.22	50.75	21.28	22.73	24.53
1752	2.59	2.60	2.48	49.69	50.23	50.76	23.54	25.11	27.06
1844	2.69	2.70	2.56	49.75	50.30	50.86	23.27	24.85	26.81
1936	2.70	2.70	2.55	49.70	50.28	50.85	23.40	24.99	26.96
2028	2.76	2.75	2.58	49.75	50.35	50.94	23.63	25.36	27.36
2100	2.54	2.53	2.36	49.80	50.40	51.02	21.55	23.04	24.91

FREQUENCY (MHz)	HARMONICS (dBc)					
	F2			F3		
	-15°C	+25°C	+65°C	-15°C	+25°C	+65°C
1230	-21.92	-22.93	-24.68	-51.92	-53.02	-54.92
1292	-24.54	-25.68	-27.44	-52.63	-53.31	-55.11
1384	-33.67	-34.79	-36.40	-55.21	-56.36	-55.44
1476	-43.51	-44.19	-45.73	-53.50	-54.69	-54.79
1568	-49.79	-50.51	-50.76	-50.17	-51.15	-52.58
1660	-47.07	-48.04	-49.20	-50.19	-50.41	-51.85
1752	-47.95	-48.72	-49.94	-55.92	-55.97	-56.43
1844	-46.49	-46.85	-48.25	-51.14	-49.69	-50.68
1936	-46.46	-47.49	-48.85	-40.88	-40.73	-41.45
2028	-46.99	-48.00	-49.45	-36.02	-35.36	-35.83
2100	-49.54	-50.68	-50.39	-33.44	-33.12	-33.62



IF/RF MICROWAVE COMPONENTS • ISO 9001 ISO 14001 AS9100 CERTIFIED RoHS compliant
 P.O. Box 350166, Brooklyn, New York 11235-0003 (718) 934-4500 Fax (718) 332-4661



The Design Engineers Search Engine finds the model you need, Instantly • For detailed performance specs & shopping online see



Notes: 1. Performance and quality attributes and conditions not expressly stated in this specification sheet are intended to be excluded and do not form a part of this specification sheet. 2. Electrical specifications and performance data contained herein are based on Mini-Circuit's applicable established test performance criteria and measurement instructions. 3. The parts covered by this specification sheet are subject to Mini-Circuits standard limited warranty and terms and conditions (collectively, "Standard Terms"); Purchasers of this part are entitled to the rights and benefits contained therein. For a full statement of the Standard Terms and the exclusive rights and remedies thereunder, please visit Mini-Circuits' website at www.minicircuits.com/MCLStore/terms.jsp.

FREQUENCY (MHz)	PHASE NOISE (dBc/Hz) @ OFFSETS				
	+25°C				
	100Hz	1kHz	10kHz	100kHz	1MHz
1230	-92.21	-99.01	-100.43	-115.22	-142.10
1292	-91.52	-99.11	-99.76	-115.65	-142.72
1384	-91.43	-98.02	-99.28	-115.97	-143.06
1476	-90.74	-98.02	-99.82	-115.50	-143.22
1568	-90.22	-97.80	-99.21	-115.79	-141.34
1660	-90.08	-98.42	-98.74	-115.85	-143.45
1752	-89.09	-96.40	-98.01	-116.41	-143.51
1844	-88.47	-96.29	-98.19	-116.13	-143.48
1936	-88.03	-96.15	-97.76	-116.72	-141.68
2028	-87.91	-95.64	-97.77	-117.03	-141.81
2100	-88.77	-96.63	-98.05	-116.75	-143.60

FREQUENCY (MHz)	PHASE NOISE (dBc/Hz) @ OFFSETS				
	-15°C				
	100Hz	1kHz	10kHz	100kHz	1MHz
1230	-91.03	-98.72	-100.58	-115.85	-143.16
1292	-87.12	-98.54	-100.01	-116.26	-143.71
1384	-87.16	-97.84	-99.47	-116.56	-144.04
1476	-90.31	-97.12	-99.73	-116.00	-144.02
1568	-86.02	-97.11	-99.22	-116.28	-143.97
1660	-88.82	-96.57	-98.32	-116.69	-143.97
1752	-86.09	-95.98	-98.20	-116.82	-143.93
1844	-84.86	-95.96	-98.13	-116.56	-142.52
1936	-86.70	-94.42	-97.70	-117.07	-143.64
2028	-85.65	-94.88	-97.63	-117.34	-144.05
2100	-83.86	-94.22	-97.13	-117.61	-143.96

FREQUENCY (MHz)	PHASE NOISE (dBc/Hz) @ OFFSETS				
	+65°C				
	100Hz	1kHz	10kHz	100kHz	1MHz
1230	-92.01	-99.74	-100.17	-114.47	-140.74
1292	-89.16	-99.23	-99.91	-114.88	-141.39
1384	-91.73	-99.14	-99.06	-115.19	-141.80
1476	-91.50	-98.57	-99.68	-114.85	-142.11
1568	-90.67	-98.76	-99.04	-115.17	-142.37
1660	-89.75	-97.81	-98.53	-115.46	-142.61
1752	-89.55	-96.70	-98.02	-115.77	-142.71
1844	-85.82	-96.29	-98.14	-115.59	-141.81
1936	-88.56	-96.28	-97.68	-116.17	-142.38
2028	-88.00	-95.29	-97.54	-116.59	-142.96
2100	-88.05	-95.73	-97.51	-116.64	-142.97



IF/RF MICROWAVE COMPONENTS • ISO 9001 ISO 14001 AS9100 CERTIFIED RoHS compliant
 P.O. Box 350166, Brooklyn, New York 11235-0003 (718) 934-4500 Fax (718) 332-4661



The Design Engineers Search Engine finds the model you need, Instantly • For detailed performance specs & shopping online see



Notes: 1. Performance and quality attributes and conditions not expressly stated in this specification sheet are intended to be excluded and do not form a part of this specification sheet. 2. Electrical specifications and performance data contained herein are based on Mini-Circuit's applicable established test performance criteria and measurement instructions. 3. The parts covered by this specification sheet are subject to Mini-Circuits standard limited warranty and terms and conditions (collectively, "Standard Terms"); Purchasers of this part are entitled to the rights and benefits contained therein. For a full statement of the Standard Terms and the exclusive rights and remedies thereunder, please visit Mini-Circuits' website at www.minicircuits.com/MCLStore/terms.jsp.

COMPARISON SPURIOUS ORDER	COMPARISON SPURIOUS @Fcarrier 1230MHz+(n*Fcomparison) (dBc) note 1			COMPARISON SPURIOUS @Fcarrier 1664MHz+(n*Fcomparison) (dBc) note 1			COMPARISON SPURIOUS @Fcarrier 2098MHz+(n*Fcomparison) (dBc) note 1			
	n	-15°C	+25°C	+65°C	-15°C	+25°C	+65°C	-15°C	+25°C	+65°C
	-5	-96.40	-94.28	-94.93	-107.96	-104.31	-104.82	-93.64	-104.47	-99.66
-4	-88.67	-86.97	-86.95	-91.06	-91.64	-91.14	-89.54	-89.60	-85.34	
-3	-100.41	-92.16	-88.48	-91.10	-89.20	-92.66	-88.33	-86.61	-90.31	
-2	-92.41	-90.13	-90.71	-107.15	-99.27	-98.37	-94.63	-97.25	-104.28	
-1	-94.41	-92.33	-91.27	-113.48	-104.24	-95.22	-98.20	-104.58	-107.79	
0 note 2	-	-	-	-	-	-	-	-	-	
+1	-92.57	-91.04	-97.06	-100.61	-107.07	-101.20	-104.32	-94.46	-91.60	
+2	-96.71	-105.48	-107.42	-96.50	-94.17	-96.94	-89.15	-88.94	-86.46	
+3	-95.78	-96.90	-101.22	-93.88	-95.51	-96.94	-89.02	-89.51	-89.50	
+4	-95.47	-94.26	-93.26	-87.07	-85.25	-87.22	-84.61	-86.15	-88.67	
+5	-99.79	-110.39	-106.43	-93.46	-91.40	-92.47	-94.63	-93.87	-96.98	

Note 1: Comparison frequency 20 MHz

Note 2: All spurs are referenced to carrier signal (n=0).

REFERENCE SPURIOUS ORDER	REFERENCE SPURIOUS @Fcarrier 1230MHz+(n*Frefernce) (dBc) note 3			REFERENCE SPURIOUS @Fcarrier 1664MHz+(n*Frefernce) (dBc) note 3			REFERENCE SPURIOUS @Fcarrier 2098MHz+(n*Frefernce) (dBc) note 3			
	n	-15°C	+25°C	+65°C	-15°C	+25°C	+65°C	-15°C	+25°C	+65°C
	-5	-99.56	-93.79	-88.95	-112.17	-109.07	-114.47	-103.88	-105.05	-103.02
-4	-92.41	-90.13	-90.71	-107.15	-99.27	-98.37	-94.63	-97.25	-104.28	
-3	-101.16	-96.13	-92.72	-112.99	-113.32	-117.61	-103.84	-107.60	-102.78	
-2	-94.41	-92.33	-91.27	-113.48	-104.24	-95.22	-98.20	-104.58	-107.79	
-1	-114.84	-106.29	-100.25	-108.80	-117.54	-115.00	-104.14	-104.43	-100.32	
0 note 4	-	-	-	-	-	-	-	-	-	
+1	-101.56	-96.30	-101.91	-107.73	-111.21	-116.21	-104.03	-104.02	-100.60	
+2	-92.57	-91.04	-97.06	-100.61	-107.07	-101.20	-104.32	-94.46	-91.60	
+3	-100.35	-99.17	-103.37	-111.69	-111.88	-116.52	-107.87	-107.41	-101.84	
+4	-96.71	-105.48	-107.42	-96.50	-94.17	-96.94	-89.15	-88.94	-86.46	
+5	-105.69	-99.33	-116.23	-114.40	-107.67	-116.48	-110.97	-106.23	-101.19	

Note 3: Reference frequency 10 MHz

Note 4: All spurs are referenced to carrier signal (n=0).



IF/RF MICROWAVE COMPONENTS • ISO 9001 ISO 14001 AS9100 CERTIFIED RoHS compliant
P.O. Box 350166, Brooklyn, New York 11235-0003 (718) 934-4500 Fax (718) 332-4661



The Design Engineers Search Engine finds the model you need, Instantly • For detailed performance specs & shopping online see



Notes: 1. Performance and quality attributes and conditions not expressly stated in this specification sheet are intended to be excluded and do not form a part of this specification sheet. 2. Electrical specifications and performance data contained herein are based on Mini-Circuit's applicable established test performance criteria and measurement instructions. 3. The parts covered by this specification sheet are subject to Mini-Circuits standard limited warranty and terms and conditions (collectively, "Standard Terms"); Purchasers of this part are entitled to the rights and benefits contained therein. For a full statement of the Standard Terms and the exclusive rights and remedies thereunder, please visit Mini-Circuits' website at www.minicircuits.com/MCLStore/terms.jsp.

STEP SIZE SPURIOUS ORDER	0.5 STEP SIZE & STEP SIZE SPURIOUS @Fcarrier 1230MHz+(n*Fstep size) (dBc) note 5			0.5 STEP SIZE & STEP SIZE SPURIOUS @Fcarrier 1664MHz+(n*Fstep size) (dBc) note 5			0.5 STEP SIZE & STEP SIZE SPURIOUS @Fcarrier 2098MHz+(n*Fstep size) (dBc) note 5			
	n	-15°C	+25°C	+65°C	-15°C	+25°C	+65°C	-15°C	+25°C	+65°C
	-5.0	-107.90	-110.47	-99.26	-106.81	-113.77	-116.48	-100.85	-111.00	-101.94
-4.5	-126.29	-108.47	-117.06	-112.22	-116.14	-112.70	-109.96	-110.95	-113.07	
-4.0	-106.11	-117.48	-110.39	-114.71	-116.39	-116.70	-112.21	-107.14	-103.09	
-3.5	-118.72	-116.54	-110.79	-116.58	-113.92	-118.07	-106.28	-108.95	-106.28	
-3.0	-117.01	-117.35	-120.68	-111.62	-107.49	-102.41	-113.89	-115.77	-114.57	
-2.5	-122.64	-115.73	-106.36	-101.53	-114.35	-111.31	-110.70	-111.14	-115.75	
-2.0	-119.34	-110.30	-111.28	-108.63	-108.73	-100.61	-113.31	-111.47	-114.07	
-1.5	-117.18	-112.12	-112.84	-113.24	-114.16	-117.86	-111.55	-114.52	-114.16	
-1.0	-120.31	-114.02	-110.16	-121.21	-122.17	-115.26	-93.15	-109.13	-106.30	
-0.5	-110.17	-93.89	-113.89	-95.50	-102.32	-110.38	-100.64	-101.61	-98.89	
0 ^{note 6}	-	-	-	-	-	-	-	-	-	
+0.5	-108.17	-91.75	-112.41	-96.80	-105.23	-111.62	-100.21	-103.84	-97.87	
+1.0	-112.30	-117.99	-100.56	-117.97	-118.65	-115.76	-90.25	-107.40	-104.88	
+1.5	-113.99	-109.12	-111.65	-111.51	-116.48	-113.39	-111.72	-114.18	-114.01	
+2.0	-111.37	-109.21	-113.24	-114.15	-106.72	-102.19	-122.42	-105.87	-115.61	
+2.5	-110.47	-112.76	-105.08	-103.04	-107.76	-104.06	-112.81	-115.33	-111.92	
+3.0	-113.83	-115.76	-111.50	-105.26	-105.64	-104.25	-116.14	-120.46	-114.86	
+3.5	-127.49	-112.49	-112.45	-115.40	-118.01	-117.76	-110.17	-115.15	-104.61	
+4.0	-108.02	-126.73	-116.10	-117.14	-114.57	-116.38	-112.59	-109.64	-113.22	
+4.5	-113.97	-104.56	-115.13	-112.66	-114.10	-112.77	-113.34	-115.35	-118.81	
+5.0	-104.82	-93.80	-104.06	-109.65	-112.22	-117.71	-104.19	-108.04	-101.24	

Note 5: Step size 2 MHz

Note 6: All spurs are referenced to carrier signal (n=0).



IF/RF MICROWAVE COMPONENTS • ISO 9001 ISO 14001 AS9100 CERTIFIED RoHS compliant
 P.O. Box 350166, Brooklyn, New York 11235-0003 (718) 934-4500 Fax (718) 332-4661



The Design Engineers Search Engine finds the model you need, Instantly • For detailed performance specs & shopping online see



Notes: 1. Performance and quality attributes and conditions not expressly stated in this specification sheet are intended to be excluded and do not form a part of this specification sheet. 2. Electrical specifications and performance data contained herein are based on Mini-Circuit's applicable established test performance criteria and measurement instructions. 3. The parts covered by this specification sheet are subject to Mini-Circuits standard limited warranty and terms and conditions (collectively, "Standard Terms"); Purchasers of this part are entitled to the rights and benefits contained therein. For a full statement of the Standard Terms and the exclusive rights and remedies thereunder, please visit Mini-Circuits' website at www.minicircuits.com/MCLStore/terms.jsp.

Typical Performance Curves

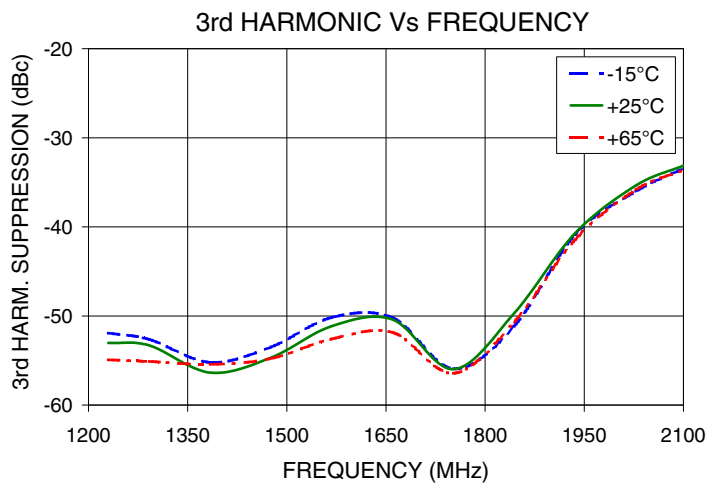
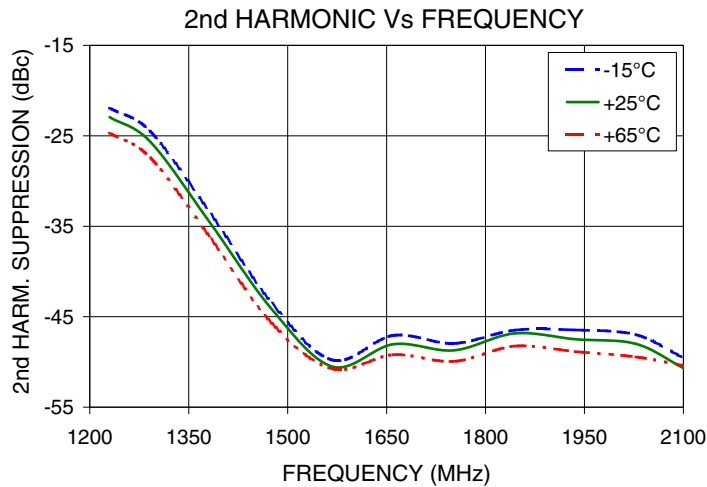
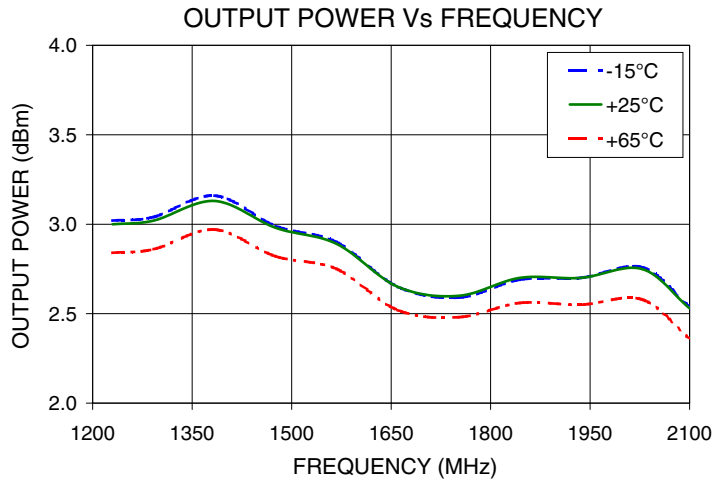

IF/RF MICROWAVE COMPONENTS • ISO 9001 ISO 14001 AS9100 CERTIFIED RoHS compliant
 P.O. Box 350166, Brooklyn, New York 11235-0003 (718) 934-4500 Fax (718) 332-4661



The Design Engineers Search Engine finds the model you need, Instantly • For detailed performance specs & shopping online see



Notes: 1. Performance and quality attributes and conditions not expressly stated in this specification sheet are intended to be excluded and do not form a part of this specification sheet. 2. Electrical specifications and performance data contained herein are based on Mini-Circuit's applicable established test performance criteria and measurement instructions. 3. The parts covered by this specification sheet are subject to Mini-Circuits standard limited warranty and terms and conditions (collectively, "Standard Terms"); Purchasers of this part are entitled to the rights and benefits contained therein. For a full statement of the Standard Terms and the exclusive rights and remedies thereunder, please visit Mini-Circuits' website at www.minicircuits.com/MCLStore/terms.jsp.

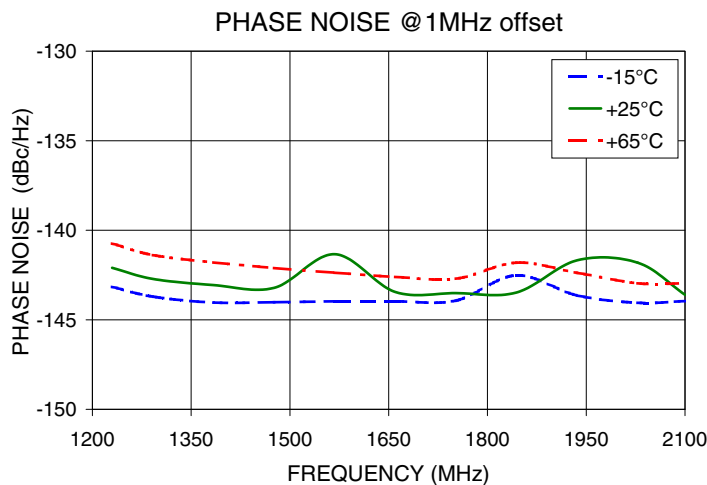
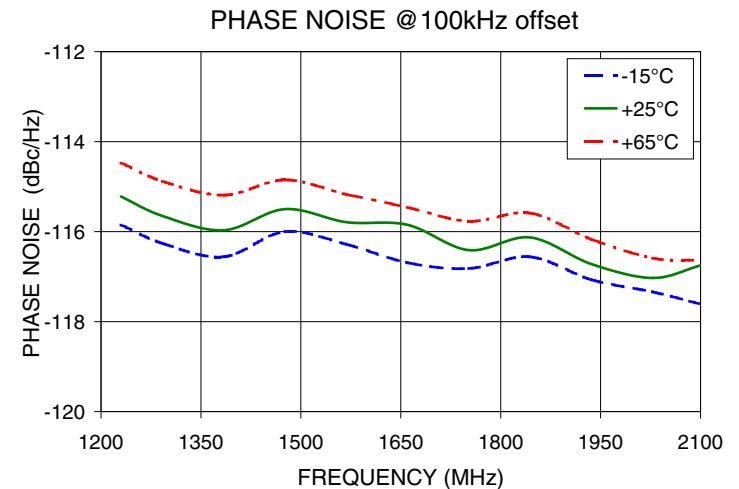
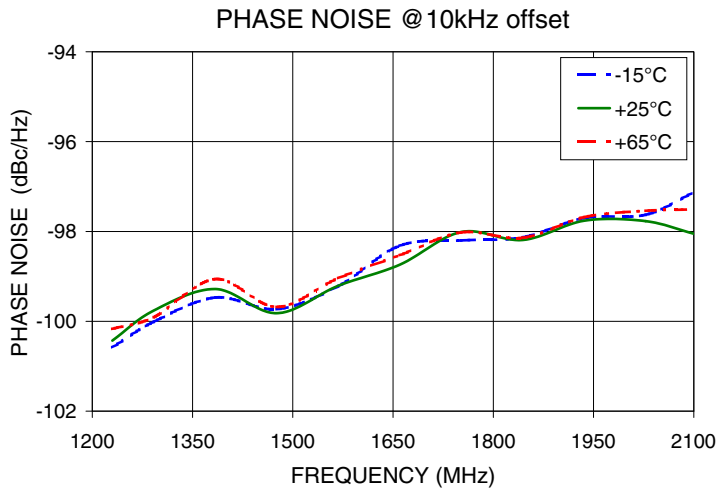
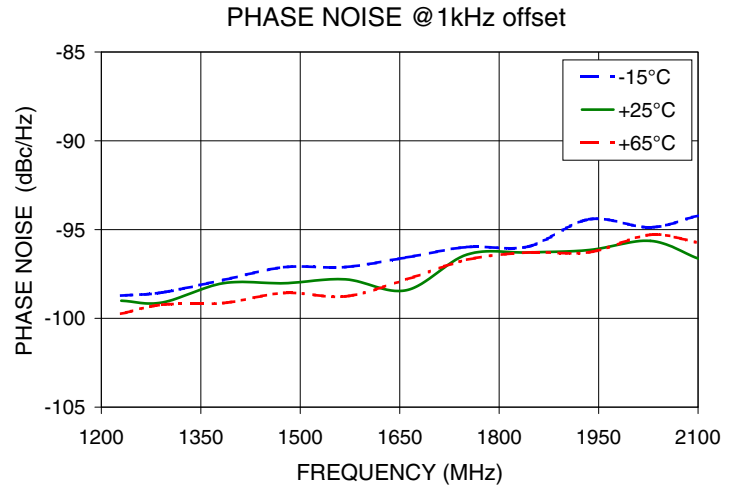
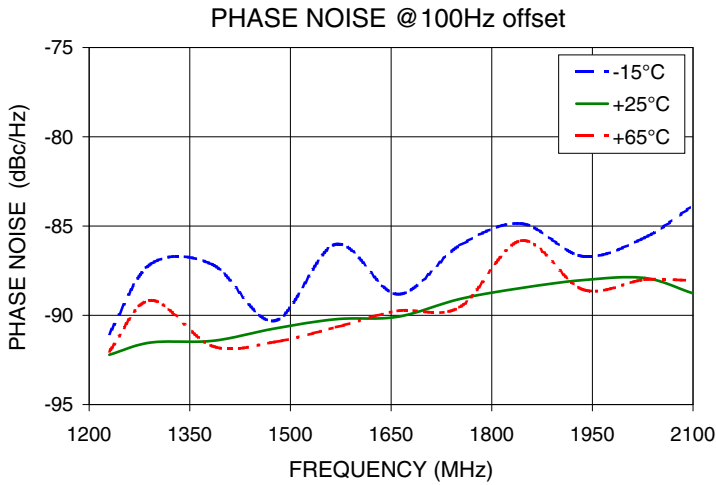

IF/RF MICROWAVE COMPONENTS • ISO 9001 ISO 14001 AS9100 CERTIFIED RoHS compliant
 P.O. Box 350166, Brooklyn, New York 11235-0003 (718) 934-4500 Fax (718) 332-4661



The Design Engineers Search Engine finds the model you need, Instantly • For detailed performance specs & shopping online see



Notes: 1. Performance and quality attributes and conditions not expressly stated in this specification sheet are intended to be excluded and do not form a part of this specification sheet. 2. Electrical specifications and performance data contained herein are based on Mini-Circuit's applicable established test performance criteria and measurement instructions. 3. The parts covered by this specification sheet are subject to Mini-Circuits standard limited warranty and terms and conditions (collectively, "Standard Terms"); Purchasers of this part are entitled to the rights and benefits contained therein. For a full statement of the Standard Terms and the exclusive rights and remedies thereunder, please visit Mini-Circuits' website at www.minicircuits.com/MCLStore/terms.jsp.

COMPARISON SPURIOUS
Vs FREQ. OFFSET @ Fcar = 1230MHz

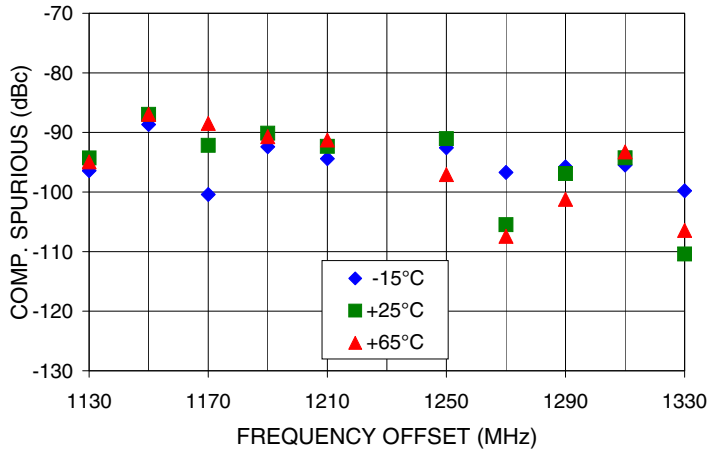

REFERENCE SPURIOUS
Vs FREQ. OFFSET @ Fcar = 1230MHz

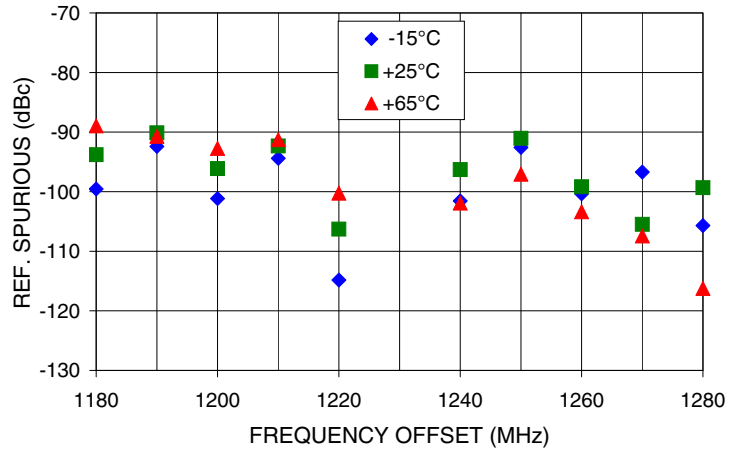

COMPARISON SPURIOUS
Vs FREQ. OFFSET @ Fcar = 1664MHz

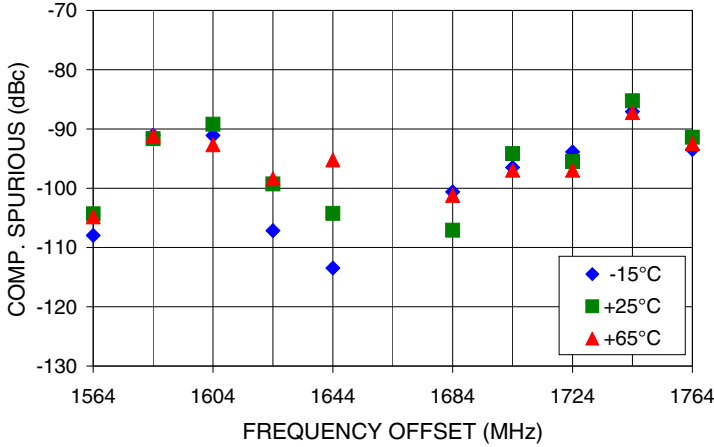

REFERENCE SPURIOUS
Vs FREQ. OFFSET @ Fcar = 1664MHz

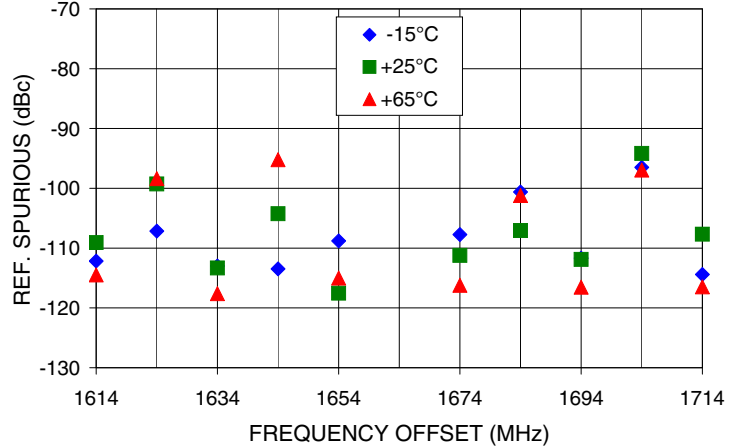

COMPARISON SPURIOUS
Vs FREQ. OFFSET @ Fcar = 2098MHz

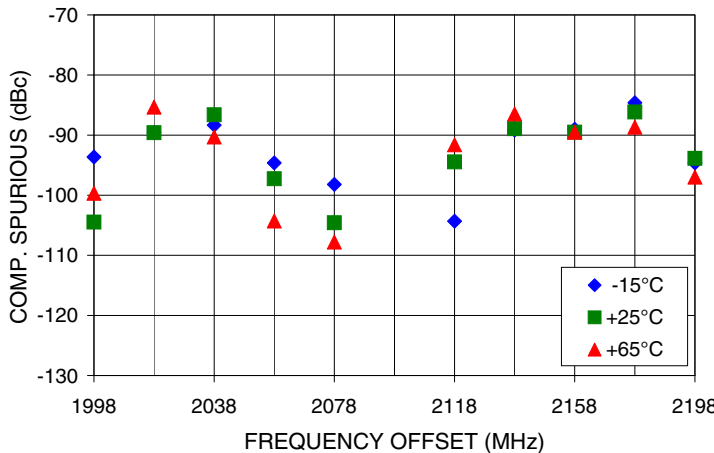

REFERENCE SPURIOUS
Vs FREQ. OFFSET @ Fcar = 2098MHz

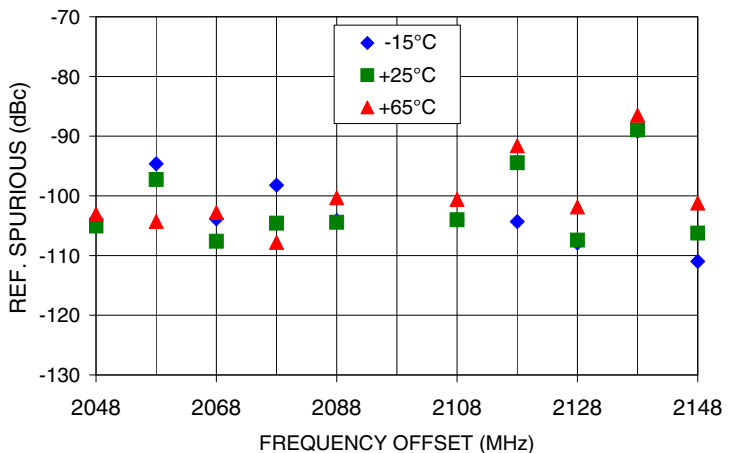

IF/RF MICROWAVE COMPONENTS • ISO 9001 ISO 14001 AS9100 CERTIFIED RoHS compliant
P.O. Box 350166, Brooklyn, New York 11235-0003 (718) 934-4500 Fax (718) 332-4661



The Design Engineers Search Engine finds the model you need, Instantly • For detailed performance specs & shopping online see



Notes: 1. Performance and quality attributes and conditions not expressly stated in this specification sheet are intended to be excluded and do not form a part of this specification sheet. 2. Electrical specifications and performance data contained herein are based on Mini-Circuit's applicable established test performance criteria and measurement instructions. 3. The parts covered by this specification sheet are subject to Mini-Circuits standard limited warranty and terms and conditions (collectively, "Standard Terms"); Purchasers of this part are entitled to the rights and benefits contained therein. For a full statement of the Standard Terms and the exclusive rights and remedies thereunder, please visit Mini-Circuits' website at www.minicircuits.com/MCLStore/terms.jsp.

0.5 STEP SIZE & STEP SIZE SPURIOUS
Vs FREQ. OFFSET @ Fcar = 1230MHz

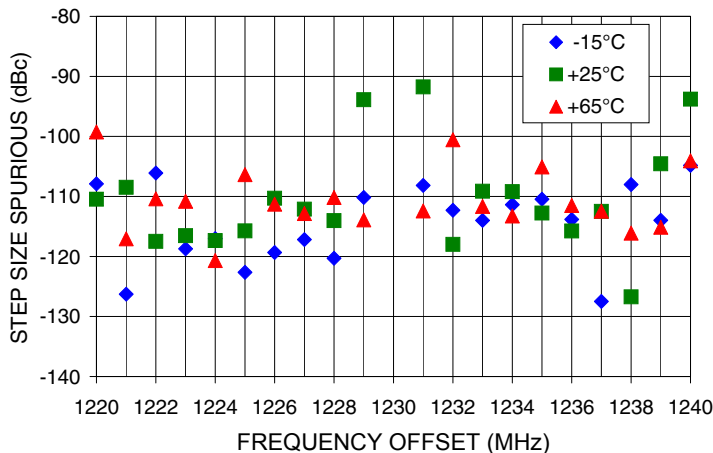

0.5 STEP SIZE & STEP SIZE SPURIOUS
Vs FREQ. OFFSET @ Fcar = 1664MHz

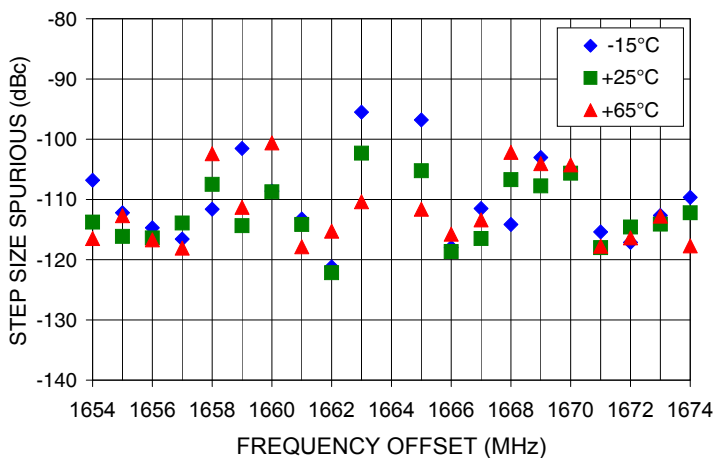

0.5 STEP SIZE & STEP SIZE SPURIOUS
Vs FREQ. OFFSET @ Fcar = 2098MHz

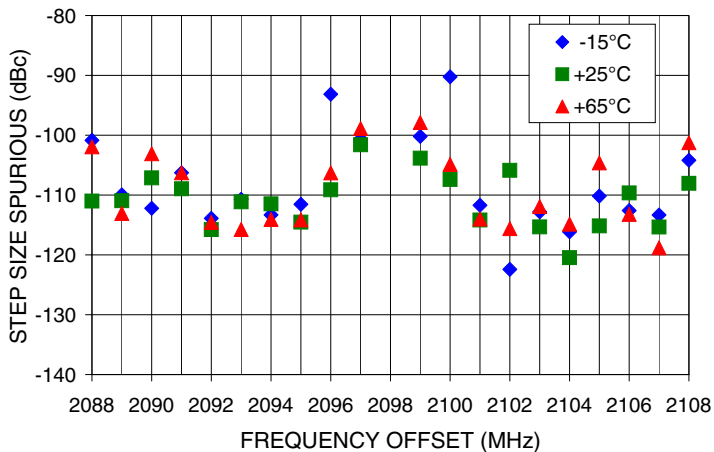

IF/RF MICROWAVE COMPONENTS • ISO 9001 ISO 14001 AS9100 CERTIFIED RoHS compliant
P.O. Box 350166, Brooklyn, New York 11235-0003 (718) 934-4500 Fax (718) 332-4661



The Design Engineers Search Engine finds the model you need, Instantly • For detailed performance specs & shopping online see



Notes: 1. Performance and quality attributes and conditions not expressly stated in this specification sheet are intended to be excluded and do not form a part of this specification sheet. 2. Electrical specifications and performance data contained herein are based on Mini-Circuit's applicable established test performance criteria and measurement instructions. 3. The parts covered by this specification sheet are subject to Mini-Circuits standard limited warranty and terms and conditions (collectively, "Standard Terms"); Purchasers of this part are entitled to the rights and benefits contained therein. For a full statement of the Standard Terms and the exclusive rights and remedies thereunder, please visit Mini-Circuits' website at www.minicircuits.com/MCLStore/terms.jsp.

Pin Configuration

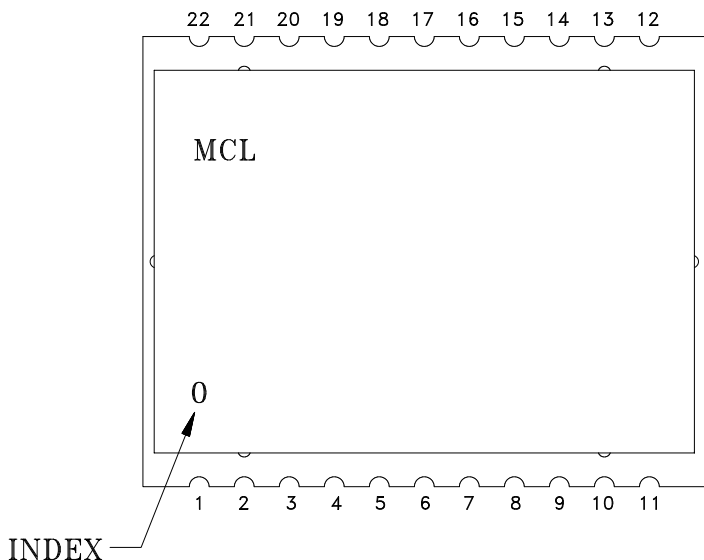

Pin Connection

Pin Number	Function	Pin Number	Function
1	GND	12	LE
2	GND	13	GND
3	GND	14	REF IN
4	GND	15	GND
5	RF OUT	16	VCC VCO
6	GND	17	GND
7	LOCK DET	18	VCC PLL
8	GND	19	GND
9	DATA	20	GND
10	GND	21	GND
11	CLOCK	22	GND

Recommended Application Circuit

Note: REF IN and RF OUT ports are internally AC coupled.

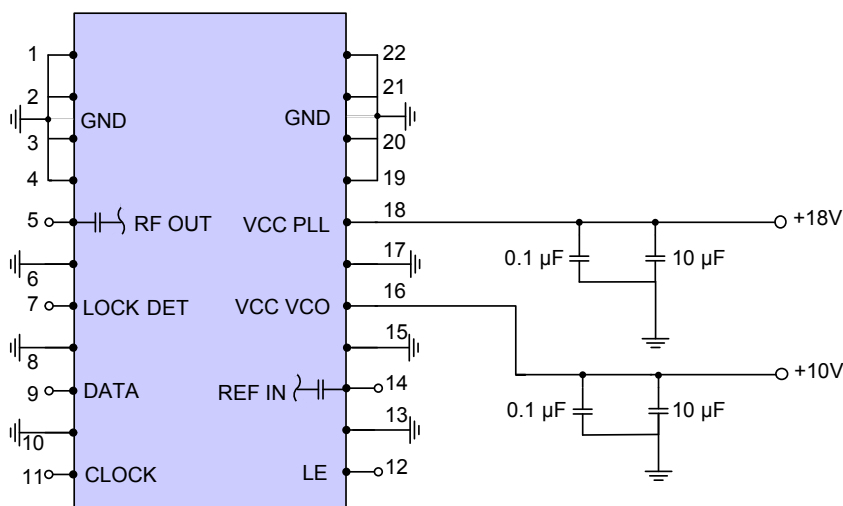

IF/RF MICROWAVE COMPONENTS • ISO 9001 ISO 14001 AS9100 CERTIFIED RoHS compliant
 P.O. Box 350166, Brooklyn, New York 11235-0003 (718) 934-4500 Fax (718) 332-4661



The Design Engineers Search Engine finds the model you need, Instantly • For detailed performance specs & shopping online see

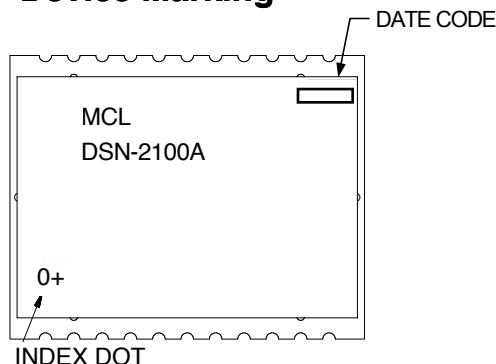

Notes: 1. Performance and quality attributes and conditions not expressly stated in this specification sheet are intended to be excluded and do not form a part of this specification sheet. 2. Electrical specifications and performance data contained herein are based on Mini-Circuit's applicable established test performance criteria and measurement instructions. 3. The parts covered by this specification sheet are subject to Mini-Circuits standard limited warranty and terms and conditions (collectively, "Standard Terms"); Purchasers of this part are entitled to the rights and benefits contained therein. For a full statement of the Standard Terms and the exclusive rights and remedies thereunder, please visit Mini-Circuits' website at www.minicircuits.com/MCLStore/terms.jsp.

Device Marking**Additional Detailed Technical Information**

Additional information is available on our web site. To access this information enter the model number on our web site home page.

Case Style: KL1294

Tape & Reel: TR-F97

Suggested Layout for PCB Design: PL-318

Evaluation Board: TB-553+

Environment Ratings: ENV03T2



IF/RF MICROWAVE COMPONENTS • ISO 9001 ISO 14001 AS9100 CERTIFIED RoHS compliant
P.O. Box 350166, Brooklyn, New York 11235-0003 (718) 934-4500 Fax (718) 332-4661



The Design Engineers Search Engine finds the model you need, Instantly • For detailed performance specs & shopping online see



Notes: 1. Performance and quality attributes and conditions not expressly stated in this specification sheet are intended to be excluded and do not form a part of this specification sheet. 2. Electrical specifications and performance data contained herein are based on Mini-Circuit's applicable established test performance criteria and measurement instructions. 3. The parts covered by this specification sheet are subject to Mini-Circuits standard limited warranty and terms and conditions (collectively, "Standard Terms"); Purchasers of this part are entitled to the rights and benefits contained therein. For a full statement of the Standard Terms and the exclusive rights and remedies thereunder, please visit Mini-Circuits' website at www.minicircuits.com/MCLStore/terms.jsp.