

# H7N1002LD, H7N1002LS, H7N1002LM

Silicon N Channel MOS FET  
High Speed Power Switching

REJ03G1131-0700  
(Previous: ADE-208-1573E)  
Rev.7.00  
Apr 07, 2006

## Features

- Low on-resistance  
 $R_{DS(on)} = 8 \text{ m}\Omega$  typ.
- Low drive current
- Available for 4.5 V gate drive

## Outline

RENESAS Package code: PRSS0004AE-A  
(Package name: LDKPAK (L) )

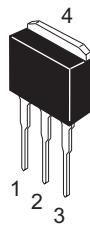

H7N1002LD

RENESAS Package code: PRSS0004AE-B  
(Package name: LDKPAK (S)-(1) )



H7N1002LS

1. Gate
2. Drain
3. Source
4. Drain

RENESAS Package code: PRSS0004AE-C  
(Package name: LDKPAK (S)-(2) )

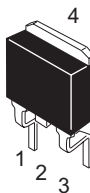

H7N1002LM

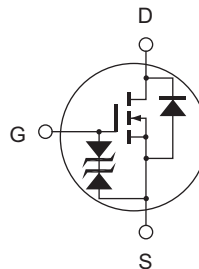

## Absolute Maximum Ratings

(Ta = 25°C)

Item	Symbol	Value	Unit
Drain to source voltage	V <sub>DSS</sub>	100	V
Gate to source voltage	V <sub>GSS</sub>	±20	V
Drain current	I <sub>D</sub>	75	A
Drain peak current	I <sub>D (pulse)</sub> <sup>Note 1</sup>	300	A
Body to drain diode reverse drain current	I <sub>DR</sub>	75	A
Avalanche current	I <sub>AP</sub> <sup>Note 3</sup>	50	A
Avalanche energy	E <sub>AR</sub> <sup>Note 3</sup>	166	mJ
Channel dissipation	P <sub>ch</sub> <sup>Note 2</sup>	100	W
Channel temperature	T <sub>ch</sub>	150	°C
Storage temperature	T <sub>stg</sub>	-55 to +150	°C

- Notes: 1. PW ≤ 10 μs, duty cycle ≤ 1%  
 2. Value at Tc = 25°C  
 3. Value at Tch = 25°C, Rg ≥ 50 Ω

## Electrical Characteristics

(Ta = 25°C)

Item	Symbol	Min	Typ	Max	Unit	Test Conditions
Drain to source breakdown voltage	V <sub>(BR) DSS</sub>	100	—	—	V	I <sub>D</sub> = 10 mA, V <sub>GS</sub> = 0
Gate to source breakdown voltage	V <sub>(BR) GSS</sub>	±20	—	—	V	I <sub>G</sub> = ±100 μA, V <sub>DS</sub> = 0
Gate to source leak current	I <sub>GSS</sub>	—	—	±10	μA	V <sub>GS</sub> = ±16 V, V <sub>DS</sub> = 0
Zero gate voltage drain current	I <sub>DSS</sub>	—	—	10	μA	V <sub>DS</sub> = 100 V, V <sub>GS</sub> = 0
Gate to source cutoff voltage	V <sub>GS (off)</sub>	1.0	—	2.5	V	I <sub>D</sub> = 1 mA, V <sub>DS</sub> = 10 V <sup>Note 4</sup>
Static drain to source on state resistance	R <sub>DS (on)</sub>	—	8	10	mΩ	I <sub>D</sub> = 37.5 A, V <sub>GS</sub> = 10 V <sup>Note 4</sup>
		—	10	15	mΩ	I <sub>D</sub> = 37.5 A, V <sub>GS</sub> = 4.5 V <sup>Note 4</sup>
Forward transfer admittance	y <sub>fs</sub>	57	95	—	S	I <sub>D</sub> = 37.5 A, V <sub>DS</sub> = 10 V <sup>Note 4</sup>
Input capacitance	C <sub>iss</sub>	—	9700	—	pF	V <sub>DS</sub> = 10 V
Output capacitance	C <sub>oss</sub>	—	740	—	pF	V <sub>GS</sub> = 0
Reverse transfer capacitance	C <sub>rss</sub>	—	330	—	pF	f = 1 MHz
Total gate charge	Q <sub>g</sub>	—	155	—	nC	V <sub>DD</sub> = 50 V
Gate to source charge	Q <sub>gs</sub>	—	35	—	nC	V <sub>GS</sub> = 10 V
Gate to drain charge	Q <sub>gd</sub>	—	33	—	nC	I <sub>D</sub> = 75 A
Turn-on delay time	t <sub>d (on)</sub>	—	43	—	ns	V <sub>GS</sub> = 10 V, I <sub>D</sub> = 37.5 A
Rise time	t <sub>r</sub>	—	245	—	ns	R <sub>L</sub> = 0.8 Ω
Turn-off delay time	t <sub>d (off)</sub>	—	130	—	ns	R <sub>g</sub> = 4.7 Ω
Fall time	t <sub>f</sub>	—	25	—	ns	
Body to drain diode forward voltage	V <sub>DF</sub>	—	0.93	—	V	I <sub>F</sub> = 75 A, V <sub>GS</sub> = 0
Body to drain diode reverse recovery time	t <sub>rr</sub>	—	70	—	ns	I <sub>F</sub> = 75 A, V <sub>GS</sub> = 0 di <sub>F</sub> /dt = 100 A/μs

- Note: 4. Pulse test

### Main Characteristics

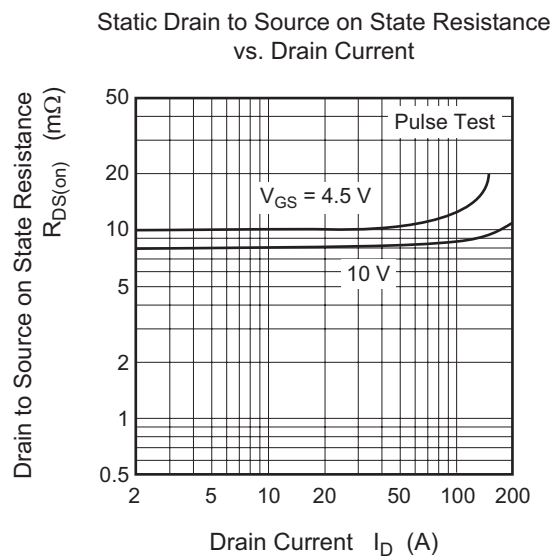
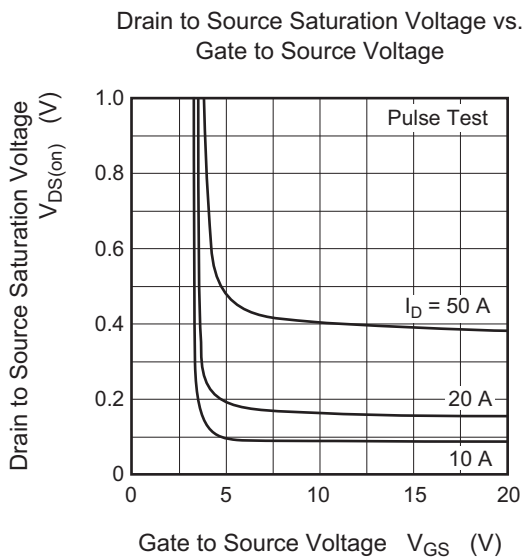
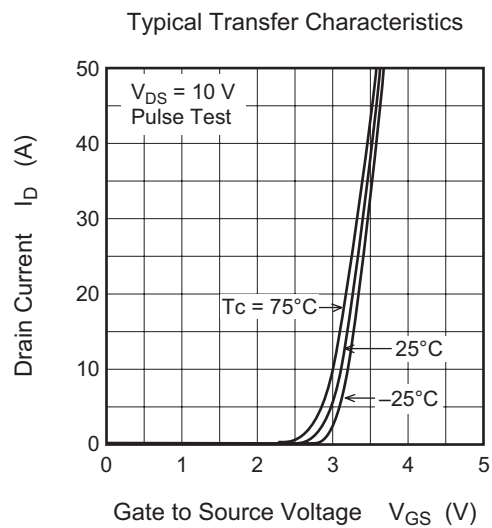
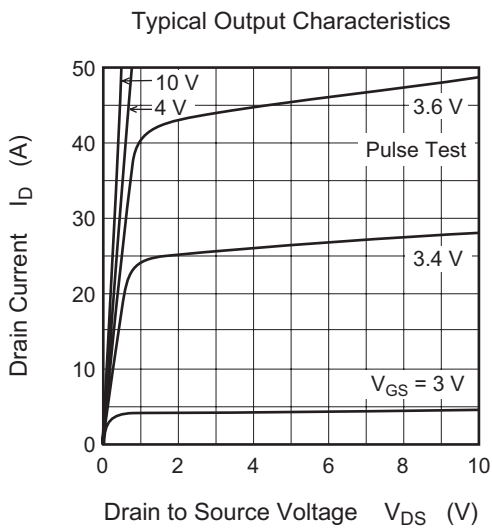
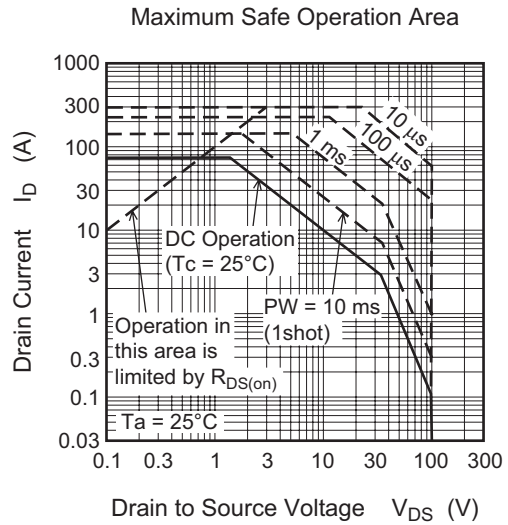
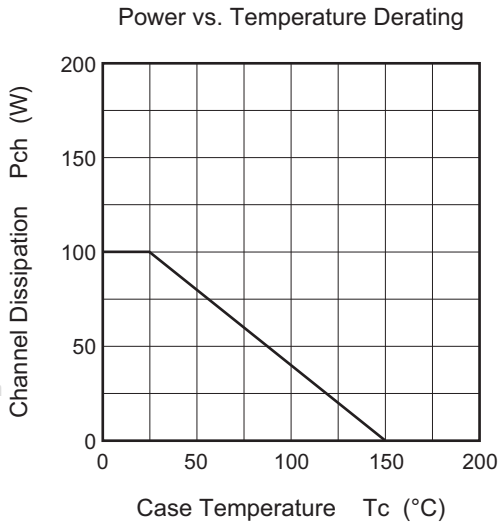

Static Drain to Source on State Resistance vs. Temperature

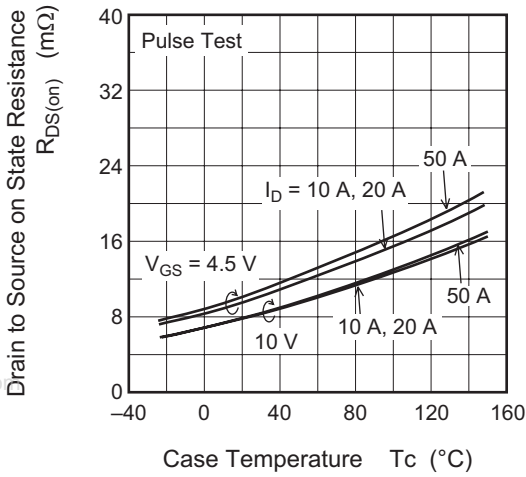

Forward Transfer Admittance vs. Drain Current

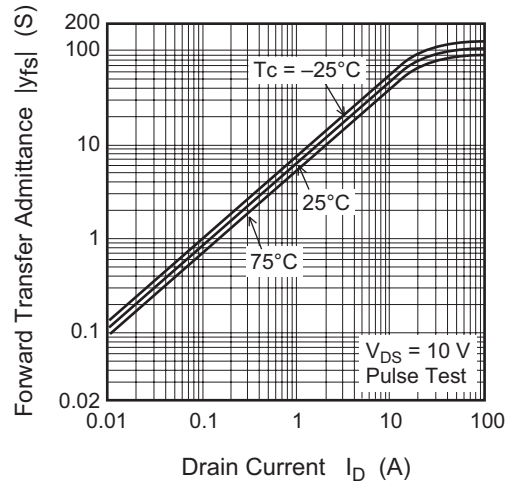

Body to Drain Diode Reverse Recovery Time

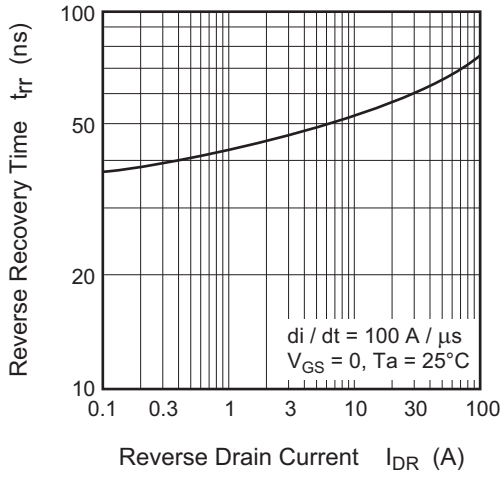

Typical Capacitance vs. Drain to Source Voltage

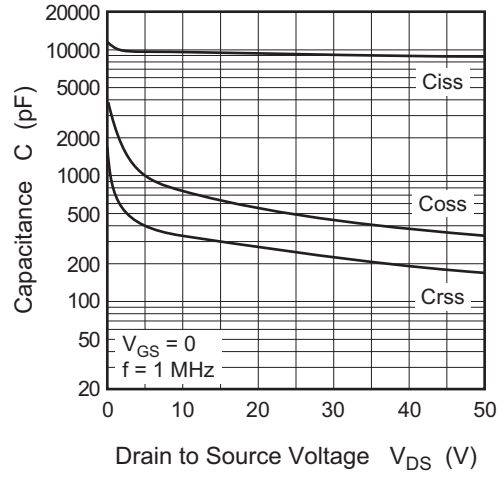

Dynamic Input Characteristics

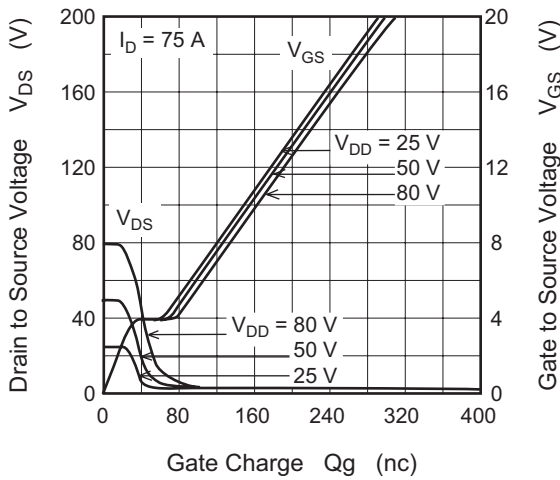

Switching Characteristics

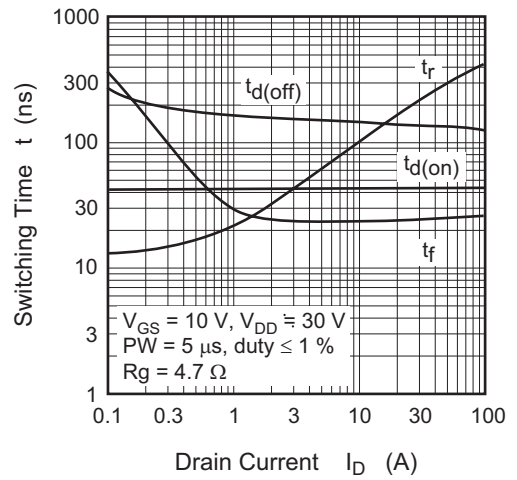

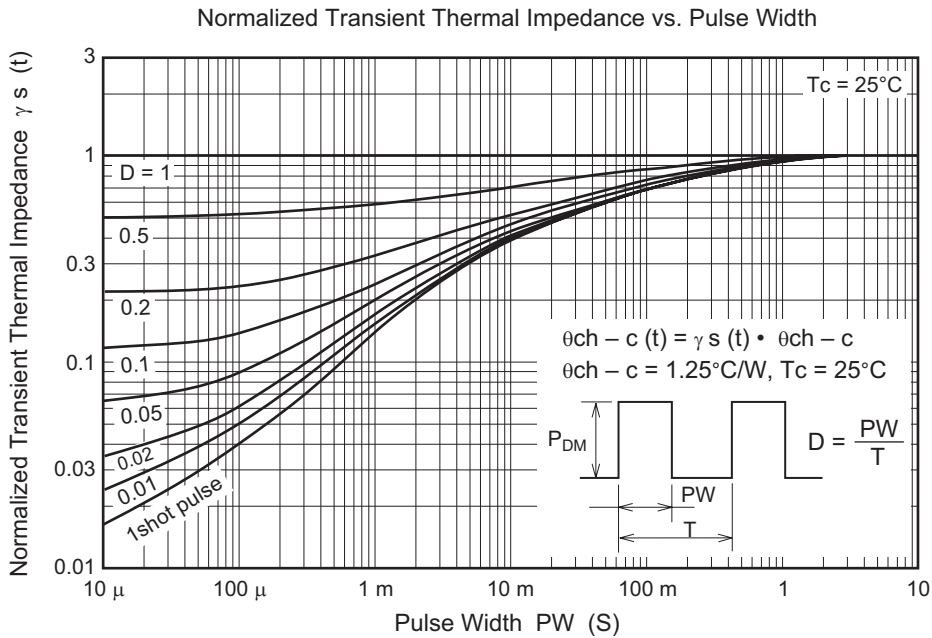
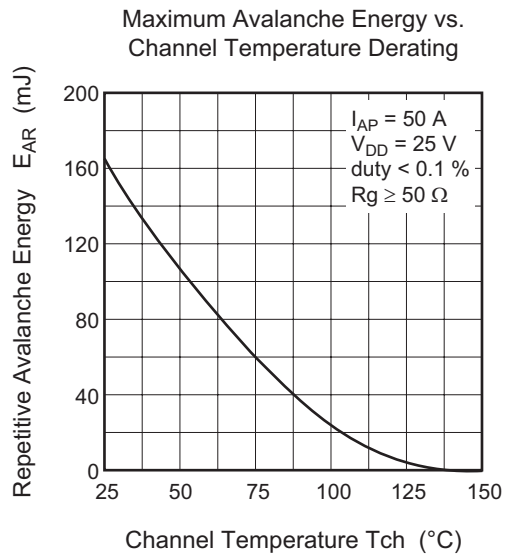
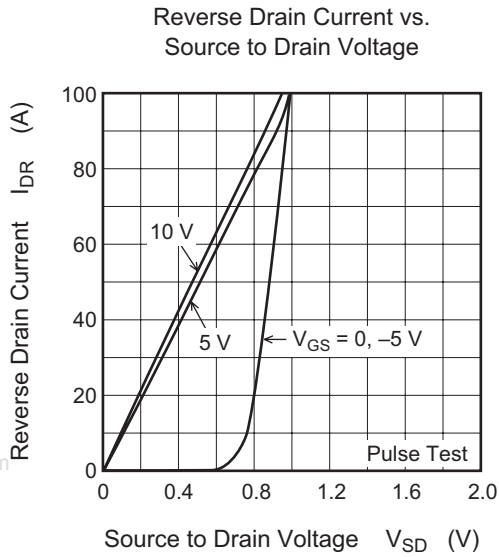

Avalanche Test Circuit

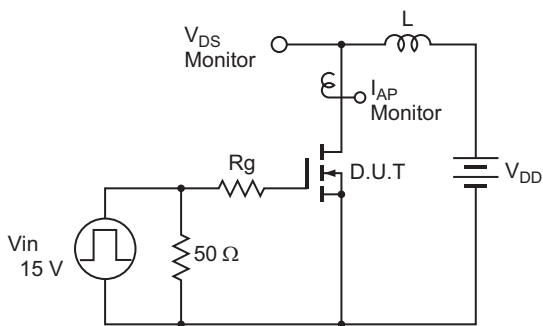

Avalanche Waveform

$$E_{AR} = \frac{1}{2} \cdot L \cdot I_{AP}^2 \cdot \frac{V_{DSS}}{V_{DSS} - V_{DD}}$$

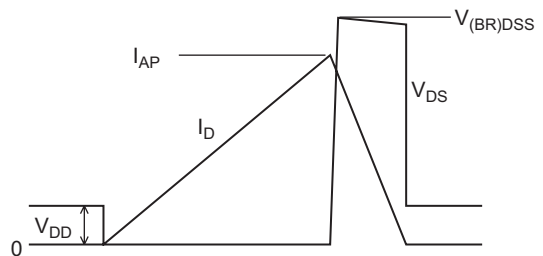

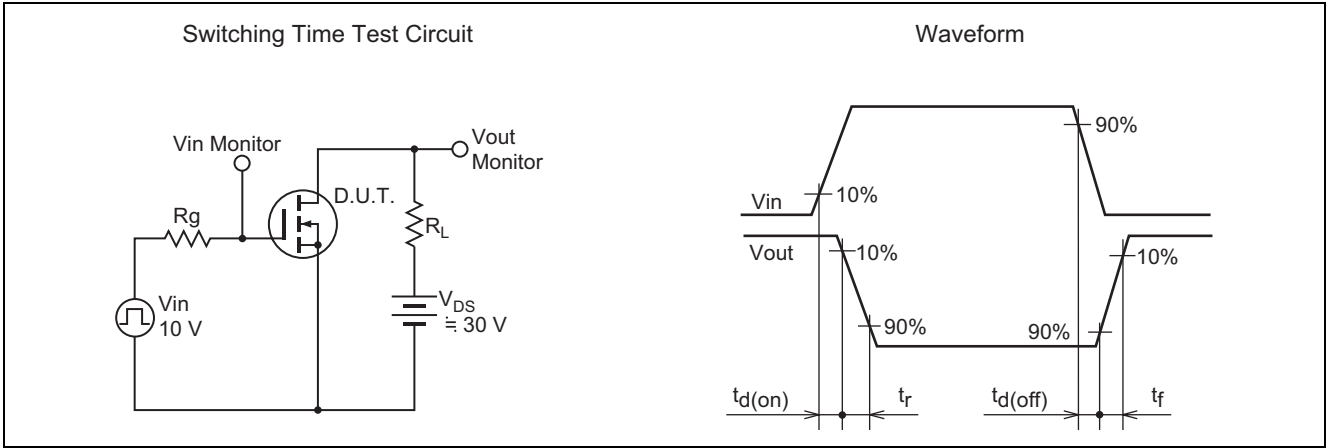

www.DataSheet4U.com

Package Dimensions

Package Name	JEITA Package Code	RENESAS Code	Previous Code	MASS[Typ.]
LDBPAK(L)	—	PRSS0004AE-A	LDBPAK(L) / LDBPAK(L)V	1.40g

Unit: mm

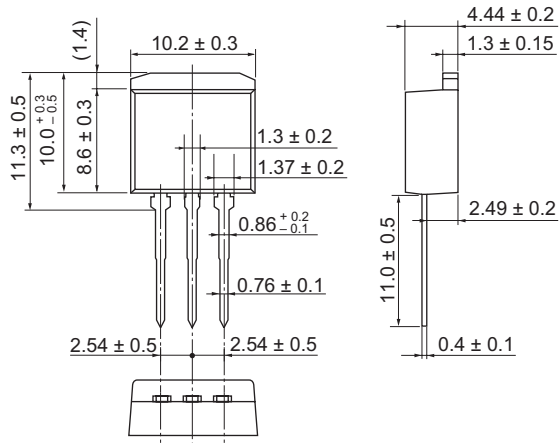

Package Name	JEITA Package Code	RENESAS Code	Previous Code	MASS[Typ.]
LDBPAK(S)-(1)	SC-83	PRSS0004AE-B	LDBPAK(S)-(1) / LDBPAK(S)-(1)V	1.30g

Unit: mm

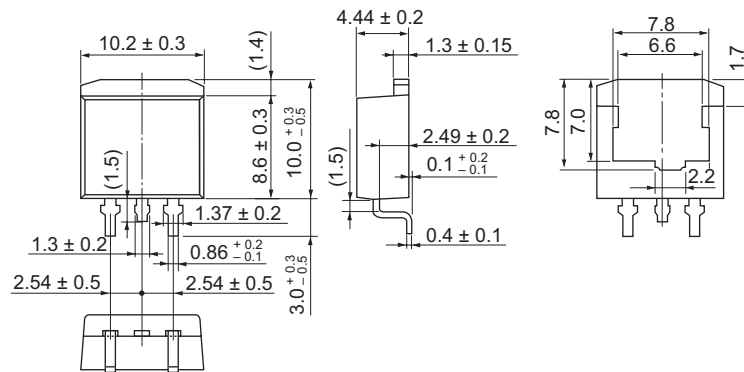

## H7N1002LD, H7N1002LS, H7N1002LM

Package Name	JEITA Package Code	RENESAS Code	Previous Code	MASS[Typ.]
LDBPAK(S)-(2)	—	PRSS0004AE-C	LDBPAK(S)-(2) / LDBPAK(S)-(2)V	1.35g

Unit: mm

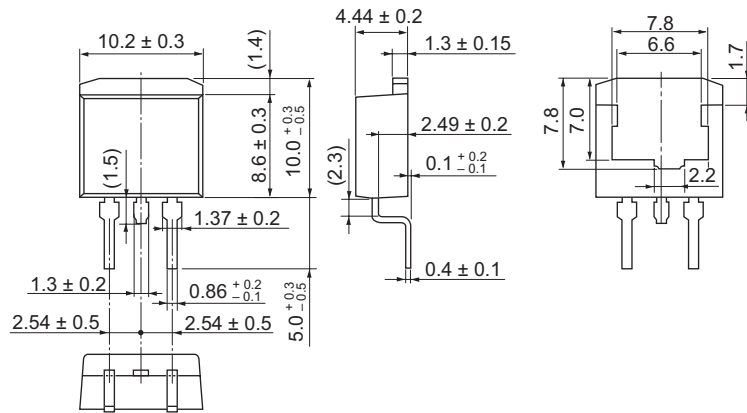

### Ordering Information

Part Name	Quantity	Shipping Container
H7N1002LD-E	500 pcs	Box (Conductive Sack)
H7N1002LSTL-E	1000 pcs	Taping
H7N1002LMTL-E	1000 pcs	Taping

Note: For some grades, production may be terminated. Please contact the Renesas sales office to check the state of production before ordering the product.



**Keep safety first in your circuit designs!**

1. Renesas Technology Corp. puts the maximum effort into making semiconductor products better and more reliable, but there is always the possibility that trouble may occur with them. Trouble with semiconductors may lead to personal injury, fire or property damage.  
Remember to give due consideration to safety when making your circuit designs, with appropriate measures such as (i) placement of substitutive, auxiliary circuits, (ii) use of nonflammable material or (iii) prevention against any malfunction or mishap.

**Notes regarding these materials**

1. These materials are intended as a reference to assist our customers in the selection of the Renesas Technology Corp. product best suited to the customer's application; they do not convey any license under any intellectual property rights, or any other rights, belonging to Renesas Technology Corp. or a third party.
2. Renesas Technology Corp. assumes no responsibility for any damage, or infringement of any third-party's rights, originating in the use of any product data, diagrams, charts, programs, algorithms, or circuit application examples contained in these materials.
3. All information contained in these materials, including product data, diagrams, charts, programs and algorithms represents information on products at the time of publication of these materials, and are subject to change by Renesas Technology Corp. without notice due to product improvements or other reasons. It is therefore recommended that customers contact Renesas Technology Corp. or an authorized Renesas Technology Corp. product distributor for the latest product information before purchasing a product listed herein.  
The information described here may contain technical inaccuracies or typographical errors.  
Renesas Technology Corp. assumes no responsibility for any damage, liability, or other loss rising from these inaccuracies or errors.  
Please also pay attention to information published by Renesas Technology Corp. by various means, including the Renesas Technology Corp. Semiconductor home page (<http://www.renesas.com>).
4. When using any or all of the information contained in these materials, including product data, diagrams, charts, programs, and algorithms, please be sure to evaluate all information as a total system before making a final decision on the applicability of the information and products. Renesas Technology Corp. assumes no responsibility for any damage, liability or other loss resulting from the information contained herein.
5. Renesas Technology Corp. semiconductors are not designed or manufactured for use in a device or system that is used under circumstances in which human life is potentially at stake. Please contact Renesas Technology Corp. or an authorized Renesas Technology Corp. product distributor when considering the use of a product contained herein for any specific purposes, such as apparatus or systems for transportation, vehicular, medical, aerospace, nuclear, or undersea repeater use.
6. The prior written approval of Renesas Technology Corp. is necessary to reprint or reproduce in whole or in part these materials.
7. If these products or technologies are subject to the Japanese export control restrictions, they must be exported under a license from the Japanese government and cannot be imported into a country other than the approved destination.  
Any diversion or reexport contrary to the export control laws and regulations of Japan and/or the country of destination is prohibited.
8. Please contact Renesas Technology Corp. for further details on these materials or the products contained therein.

**RENESAS SALES OFFICES**<http://www.renesas.com>Refer to "<http://www.renesas.com/en/network>" for the latest and detailed information.**Renesas Technology America, Inc.**450 Holger Way, San Jose, CA 95134-1368, U.S.A  
Tel: <1> (408) 382-7500, Fax: <1> (408) 382-7501**Renesas Technology Europe Limited**Dukes Meadow, Millboard Road, Bourne End, Buckinghamshire, SL8 5FH, U.K.  
Tel: <44> (1628) 585-100, Fax: <44> (1628) 585-900**Renesas Technology (Shanghai) Co., Ltd.**Unit 204, 205, AZIACenter, No.1233 Lujiazui Ring Rd, Pudong District, Shanghai, China 200120  
Tel: <86> (21) 5877-1818, Fax: <86> (21) 6887-7898**Renesas Technology Hong Kong Ltd.**7th Floor, North Tower, World Finance Centre, Harbour City, 1 Canton Road, Tsimshatsui, Kowloon, Hong Kong  
Tel: <852> 2265-6688, Fax: <852> 2730-6071**Renesas Technology Taiwan Co., Ltd.**10th Floor, No.99, Fushing North Road, Taipei, Taiwan  
Tel: <886> (2) 2715-2888, Fax: <886> (2) 2713-2999**Renesas Technology Singapore Pte. Ltd.**1 Harbour Front Avenue, #06-10, Keppel Bay Tower, Singapore 098632  
Tel: <65> 6213-0200, Fax: <65> 6278-8001**Renesas Technology Korea Co., Ltd.**Kukje Center Bldg. 18th Fl., 191, 2-ka, Hangang-ro, Yongsan-ku, Seoul 140-702, Korea  
Tel: <82> (2) 796-3115, Fax: <82> (2) 796-2145**Renesas Technology Malaysia Sdn. Bhd**Unit 906, Block B, Menara Amcorp, Amcorp Trade Centre, No.18, Jalan Persiaran Barat, 46050 Petaling Jaya, Selangor Darul Ehsan, Malaysia  
Tel: <603> 7955-9390, Fax: <603> 7955-9510