

Typical Applications

The HMC392LH5 is ideal for:

- Point-to-Point Radios
- VSAT
- LO Driver for HMC Mixers
- Military EW, ECM, C³I
- Space

Features

- High Gain: 15.4 dB
- Low Noise Figure: 2.5 dB
- Single Positive Supply: +5V
- DC Blocked & 50 Ohm Matched RF I/Os
- No External Matching Components Required
- Hermetic SMT Package, 25 mm²

Functional Diagram

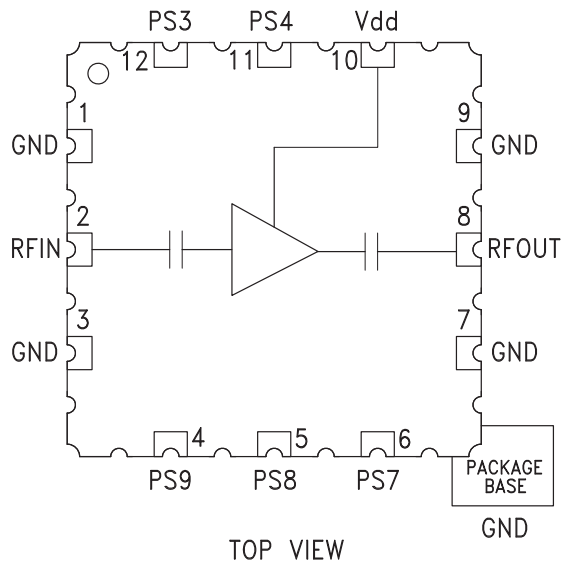

General Description

The HMC392LH5 is a GaAs MMIC Low Noise Amplifier packaged in a hermetic surface mount package which operates between 3.5 and 7 GHz. The amplifier provides 15.4 dB of gain, 2.5 dB noise figure, and +24.5 dBm output IP3 from a single +5V supply. The HMC392LH5 has six biasing options which allow the user to select the bias point and output power of the device (+13 to +17 dBm). The HMC392LH5 functions well as a low noise or driver amplifier and is ideal for driving the LO port of Hittite mixers. The HMC392LH5 is well suited for high reliability military, industrial and space applications.

Electrical Specifications, $T_A = +25^\circ \text{C}$, $V_{dd} = +5\text{V}$, $PS4 = PS8 = \text{GND}$

Parameter	Min.	Typ.	Max.	Min.	Typ.	Max.	Units
Frequency Range	4 - 6		3.5 - 7				GHz
Gain	12.8	15.4		12	15.2		dB
Gain Variation Over Temperature		0.018	0.025		0.018	0.025	dB/ °C
Noise Figure		2.5	3.2		2.7	3.7	dB
Input Return Loss		15			12		dB
Output Return Loss		17			15		dB
Output Power for 1 dB Compression (P1dB)	11	13.5			14		dBm
Saturated Output Power (P _{sat})		17.5			17.5		dBm
Output Third Order Intercept (IP3)	22	24.5		21	24.5		dBm
Supply Current (I _{dd})		43	60		43	60	mA

Note: Data taken with pins PS4 & PS8 connected to ground and pins PS3, PS4, PS6 & PS7 unconnected (state 5) unless otherwise noted.



Broadband Gain & Return Loss

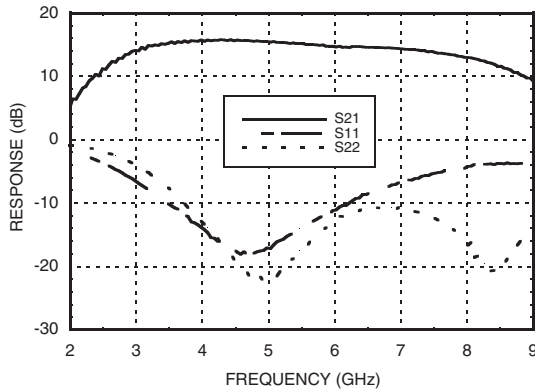

Gain vs. Temperature

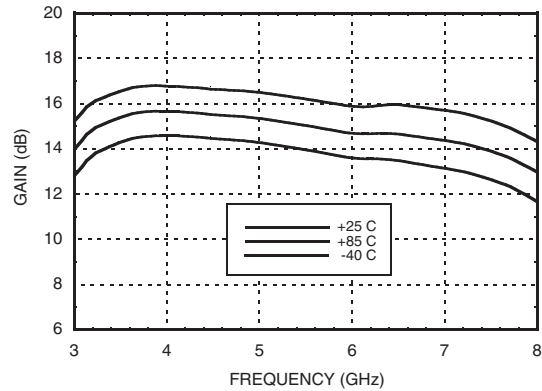

Input Return Loss vs. Temperature

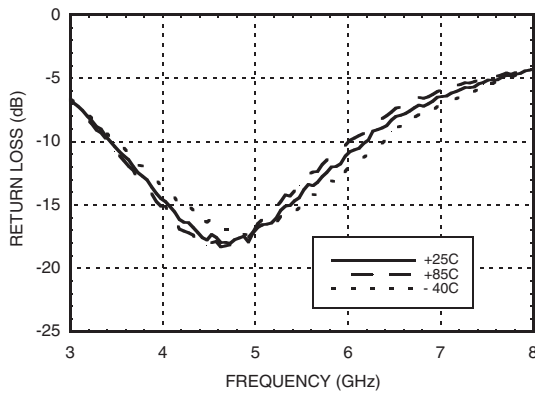

Output Return Loss vs. Temperature

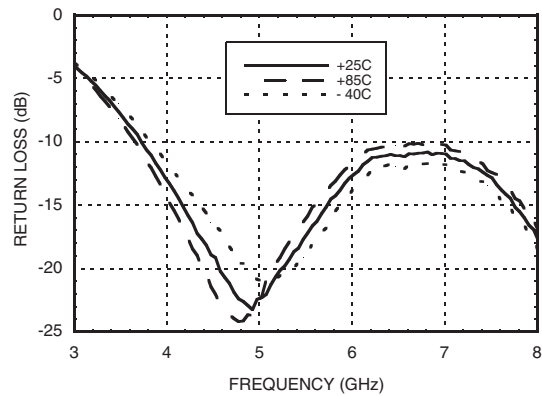

Noise Figure vs. Temperature

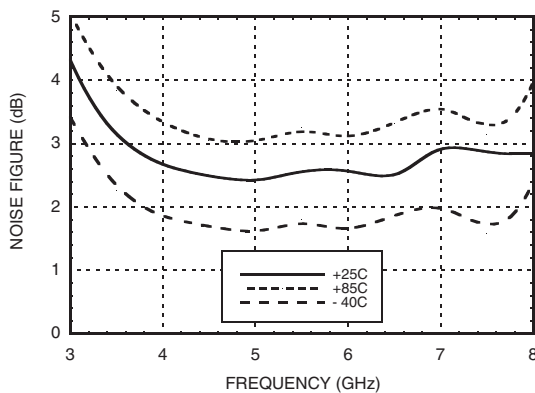

Reverse Isolation vs. Temperature

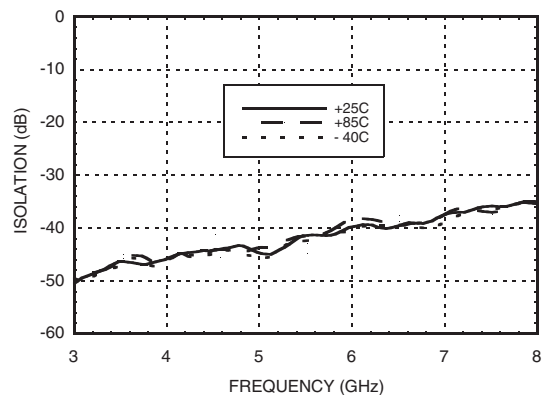



Output P1dB vs. Temperature

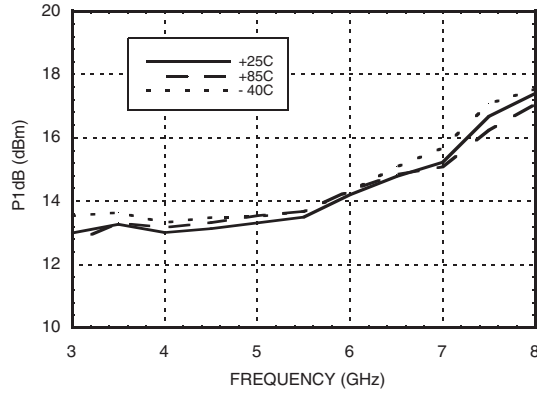

Psat vs. Temperature

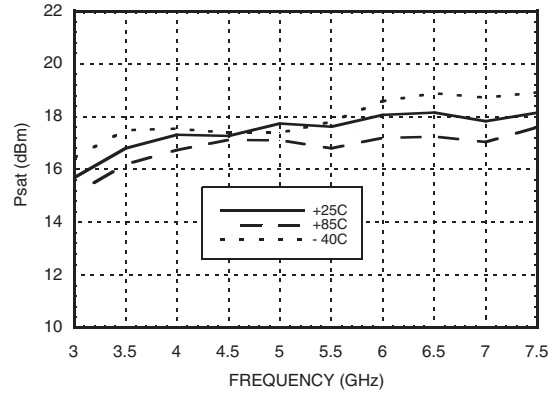

Output IP3 vs. Temperature

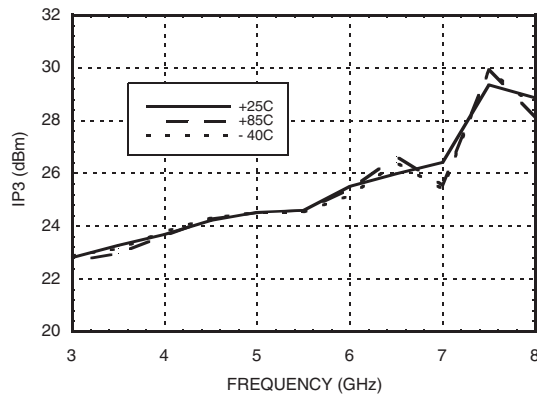

**Gain, Noise Figure & Output Power vs.
Supply Voltage @ 5.5 GHz**

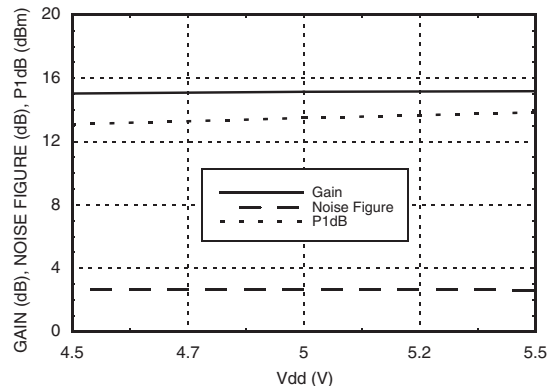

Output P1dB vs. Power Select State

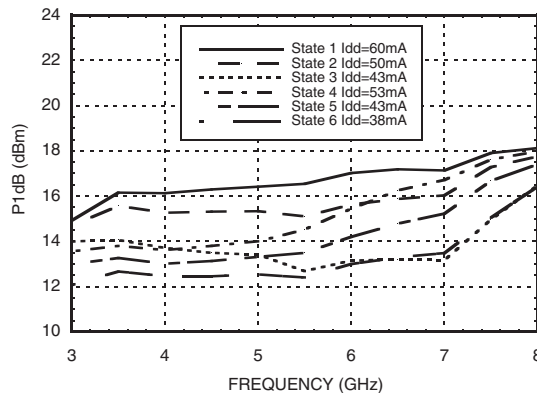

**Gain & Noise Figure vs.
Power Select State**

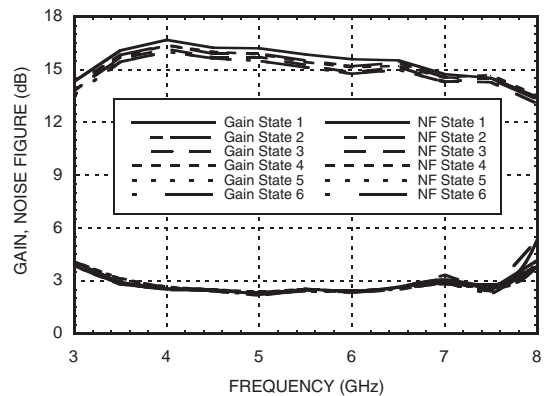

Power Compression @ 5.5 GHz

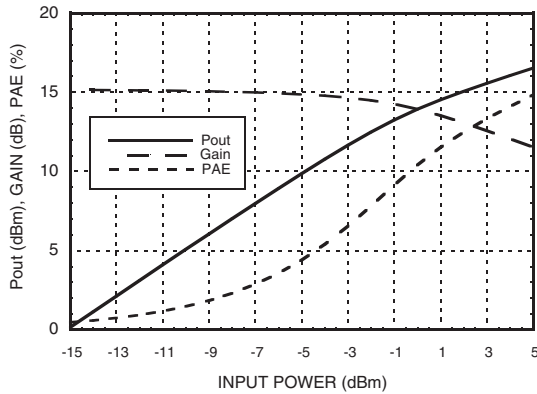

Absolute Maximum Ratings

Drain Bias Voltage (Vdd)	+8 Vdc
RF Input Power (RFIN)(Vdd = +5 Vdc)	+10 dBm
Channel Temperature	175 °C
Continuous P _{diss} (T= 85 °C) (derate 6.99 mW/°C above 85 °C)	0.629 W
Thermal Resistance (channel to ground paddle)	143.08 °C/W
Storage Temperature	-65 to +150 °C
Operating Temperature	-40 to +85° C

Typical Supply Current vs. Vdd

Vdd (Vdc)	I _{dd} (mA)
+4.5	43
+5.0	44
+5.5	45

(State 5 Depicted)

Outline Drawing

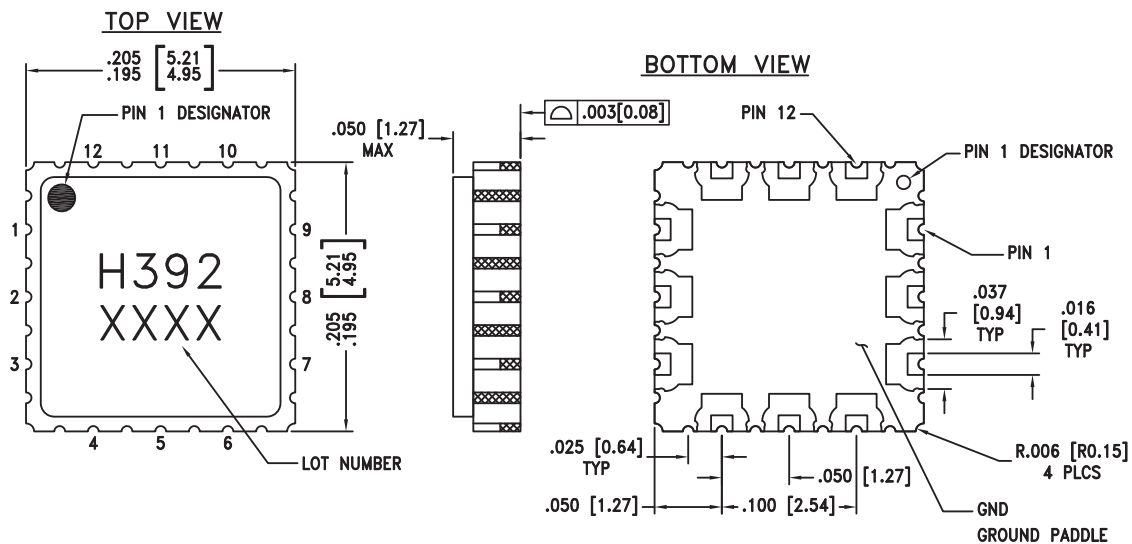



NOTES:

1. PACKAGE BODY MATERIAL: CERAMIC & KOVAR
2. LEAD AND GROUND PADDLE PLATING: GOLD 40 - 80 MICROINCHES.
3. DIMENSIONS ARE IN INCHES [MILLIMETERS].
4. LEAD SPACING TOLERANCE IS NON-CUMULATIVE
5. PAD BURR LENGTH 0.15mm MAX.
PAD BURR HEIGHT 0.25mm MAX.
6. ALL GROUND LEADS AND GROUND PADDLE MUST BE SOLDERED TO PCB RF GROUND.

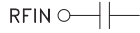
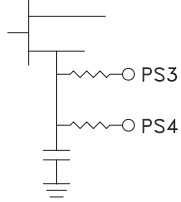
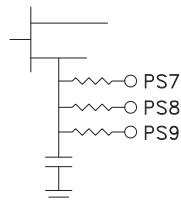
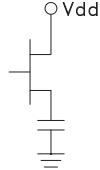
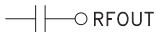

Pin Descriptions

Pin Number	Function	Description	Interface Schematic
2	RFIN	This pin is AC coupled and matched to 50 Ohms.	
12 11	Power Select PS3 PS4	One of these pins must be connected to ground and one must be unconnected. See Power Select Table for selection criteria.	
6 5 4	Power Select PS7 PS8 PS9	One of these pins must be connected to ground and two must be unconnected. See Power Select Table for selection criteria.	
10	Vdd	Power supply voltage for amplifier. External bypass 100pF, 1000pF and 4.7 μF are required.	
8	RFOUT	This pin is AC coupled and matched to 50 Ohms.	
1, 3, 7, 9	GND	These pins and package bottom must be connected to RF/DC ground.	

Power Select Table

State	Pins Connected to Ground	Typical I _{dd} (mA)	Typical Output P _{1dB} (dBm)	Typical Gain (dB)	Typical Noise Figure (dB)
1	PS3 & PS7	60	16.8	16.0	2.7
2	PS3 & PS8	50	15.7	15.5	2.7
3	PS3 & PS9	43	13.5	15.3	2.9
4	PS4 & PS7	53	15.5	15.4	2.9
5	PS4 & PS8	43	14.0	15.2	2.7
6	PS4 & PS9	38	12.8	15.2	2.7

Evaluation PCB

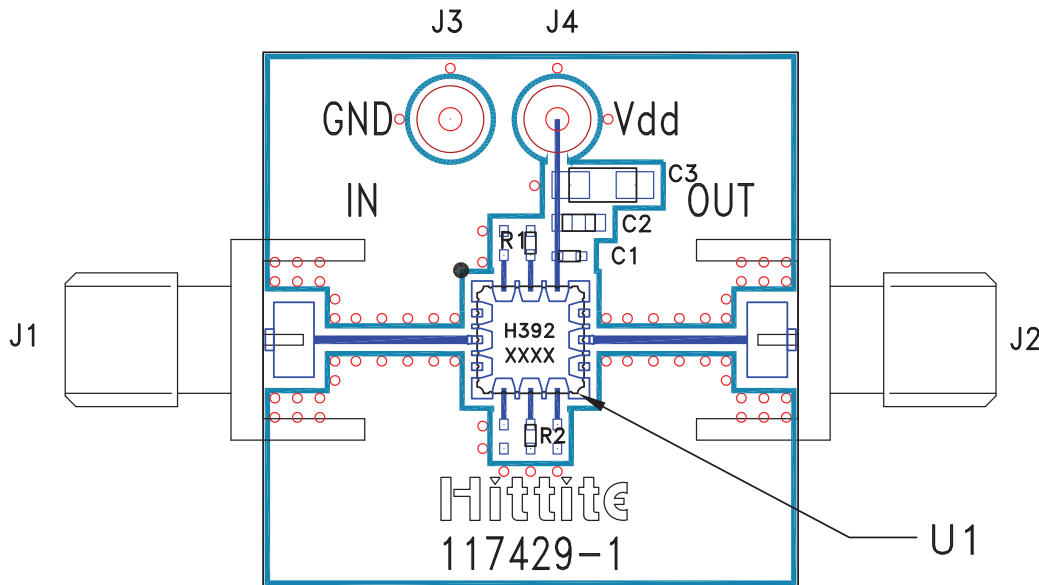

List of Materials for Evaluation PCB 117431 [1]

Item	Description
J1, J2	SMA
J3 - J4	DC Pin
C1	100 pF capacitor, 0402 pkg.
C2	1,000 pF Capacitor, 0603 pkg.
C3	4.7 μ F Capacitor, Tantalum
U1	HMC392LH5 Amplifier
PCB [2]	117429 Evaluation PCB

[1] Reference this number when ordering complete evaluation PCB

[2] Circuit Board Material: Rogers 4350.

The circuit board used in this application should use RF circuit design techniques. Signal lines should have 50 ohm impedance while the package ground leads and exposed paddle should be connected directly to the ground plane similar to that shown. A sufficient number of via holes should be used to connect the top and bottom ground planes. The evaluation board should be mounted to an appropriate heat sink. The evaluation circuit board shown is available from Hittite upon request.