



General Purpose Type Photocoupler

LTV-4N35 Series/LTV-4N37 Series 4N35 Series/4N37 Series

Features

- High current transfer ratio
(CTR : MIN.100% at $I_f=10\text{mA}$, $V_{CE}=10\text{V}$)
- Response time
(t_{on} : TYP, $3\mu\text{s}$ at $V_{CE}=10\text{V}$, $I_c=2\text{mA}$, $R_L=100\ \Omega$)
- Input-output isolation voltage :
LTV-4N35(Viso : 3,550Vrms)
LTV-4N37(Viso : 1,550Vrms)
- UL approved (No. E113898)
- TUV approved (No.R9653630)
- CSA approved (No. CA91533-1)
- FIMKO approved (No. 193422)
- NEMKO approved (No. P96103013)
- DEMKO approved (No. 303985)
- SEMKO approved (No. 9646047/01-30)
- VDE approved (No. 094722)
- Options available :
 - Leads with 0.4"(10.16mm)spacing (M Type)
 - Leads bends for surface mounting(S Type)
 - Tape and Reel of Type I for SMD(Add"-TA"Suffix)
 - Tape and Reel of Type II for SMD(Add"-TA1"Suffix)
 - VDE 0884 approvals (Add"-V"Suffix)

Applications

1. I/O interfaces for computers.
2. System appliances, measuring instruments.
3. Signal transmission between circuits of different potentials and impedances.

Package Dimensions

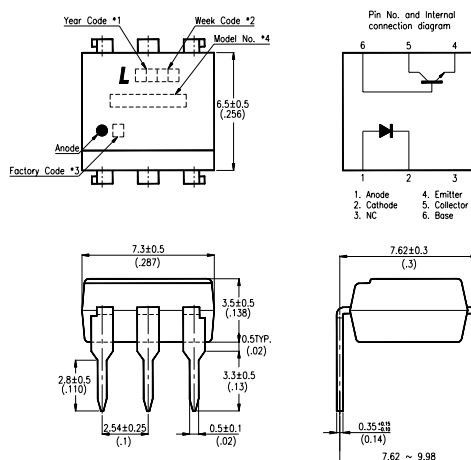

Note:

1. Year date code.
2. 2-digit work week.
3. Factory code shall be marked (Z : Taiwan, Y : Thailand).
4. Model No.:LTV4N35 ; LTV4N37 ; 4N35 ; 4N37
5. All dimensions are in millimeters (inches).
6. Tolerance is $\pm 0.25\text{mm}$ (.010") unless otherwise noted.
7. Specifications are subject to change without notice.

Ordering Information

Part Number	Package	Safety Standard Approval	Application part number
LTV-4N35 / 4N35 LTV-4N35M / 4N35M LTV-4N35S / 4N35S LTV-4N35S-TA / 4N35S-TA LTV-4N35S-TA1 / 4N35S-TA1	6-pin DIP 6-pin (leads with 0.4" spacing) 6-pin (lead bends for surface mount) 6-pin (tape and reel packaging of type I) 6-pin (tape and reel packaging of type II)	<ul style="list-style-type: none"> • UL approved • TUV approved • CSA approved • FIMKO approved • NEMKO approved • SEMKO approved • DEMKO approved 	LTV - 4N35
LTV-4N37 / 4N37 LTV-4N37M / 4N37M LTV-4N37S / 4N37S LTV-4N37S-TA / 4N37S-TA LTV-4N37S-TA1 / 4N37S-TA1	6-pin DIP 6-pin (leads with 0.4" spacing) 6-pin (lead bends for surface mount) 6-pin (tape and reel packaging of type I) 6-pin (tape and reel packaging of type II)		LTV - 4N37
LTV4N35-V / 4N35-V LTV4N35M-V / 4N35M-V LTV4N35S-V / 4N35S-V LTV4N35STA-V / 4N35STA-V LTV4N35STA1-V / 4N35STA1-V	6-pin DIP 6-pin (leads with 0.4" spacing) 6-pin (lead bends for surface mount) 6-pin (tape and reel packaging of type I) 6-pin (tape and reel packaging of type II)	<ul style="list-style-type: none"> • VDE approved 	LTV - 4N35
LTV4N37-V / 4N37-V LTV4N37M-V / 4N37M-V LTV4N37S-V / 4N37S-V LTV4N37STA-V / 4N37STA-V LTV4N37STA1-V / 4N37STA1-V	6-pin DIP 6-pin (leads with 0.4" spacing) 6-pin (lead bends for surface mount) 6-pin (tape and reel packaging of type I) 6-pin (tape and reel packaging of type II)		www.DataSheet4U.com LTV - 4N37

Absolute Maximum Ratings

(Ta=25°C)

Parameter		Symbol	Rating	Unit
Input	Forward Current	I _F	60	mA
	Reverse Voltage	V _R	6	V
	Power Dissipation	P	100	mW
Output	Collector-Emitter Voltage	V _{CEO}	30	V
	Collector-Base Voltage	V _{CBO}	70	V
	Emitter-Collector Voltage	V _{ECO}	7	V
	Collector Current	I _C	100	mA
	Collector Power Dissipation	P _C	300	mW
Total Power Dissipation		P _{tot}	350	mW
*1. Isolation Voltage	4N35	V _{iso}	3,550	V _{rms}
	4N37		1,500	
Operating Temperature		T _{opr}	-55~+100	°C
Storage Temperature		T _{stg}	-55~+150	°C
*2. Soldering Temperature		T _{sol}	260	°C

*1. AC for 1 minute, R.H. = 40 ~ 60%

• Isolation voltage shall be measured using the following method.

(1) Short between anode and cathode on the primary side and between collector, emitter and base on the secondary side.

(2) The isolation voltage tester with zero-cross circuit shall be used.

(3) The waveform of applied voltage shall be a sine wave.

*2. For 10 seconds.

Electrical/Optical Characteristics

(Ta=25°C)

Parameter		Symbol	Min.	Typ.	Max.	Unit	Conditions	
Input	Forward Voltage	V _F	—	1.2	1.5	V	I _F =10mA	
	Reverse Current	I _R	—	—	10	μA	V _R =4V	
	Terminal Capacitance	C _t	—	50	—	pF	V=0, f=1kHz	
Output	Collector Dark Current	I _{CEO}	Ta=25°C	—	—	50	nA	V _{CE} =10V
			Ta=25°C	—	—	500	μA	V _{CE} =30V
	Collector-Emitter Breakdown Voltage	BV _{CEO}	30	—	—	V	I _C =0.1mA	
	Emitter-Collector Breakdown Voltage	BV _{ECO}	7	—	—	V	I _E =10 μA	
Collector-Base Breakdown Voltage	BV _{CBO}	70	—	—	V	I _C =0.1mA		
Transfer Characteristics	Collector Current	Ta=25°C	I _C	10	—	—	mA	I _F =10mA V _{CE} =10V
	*1 Current Transfer Ratio	Ta=25°C	CTR	100	—	—	%	I _F =10mA V _{CE} =10V
	Collector-emitter Saturation Voltage		V _{CE(sat)}	—	—	0.3	V	I _F =50mA, I _C =2mA
	Isolation Resistance		R _{iso}	5 × 10 ¹⁰	1 × 10 ¹¹	—	Ω	DC500V, 40~60% R.H.
	Floating Capacitance		C _f	—	1.0	2.5	pF	V=0, f=1MHz
	Response Time (Turn-on Time)		t _{on}	—	3	10	μs	V _{CE} =10V, R _{BE} = ∞
	Response Time (Turn-off Time)		t _{off}	—	3	10	μs	R _L =100 Ω, I _C =2mA

*1. CTR = $\frac{I_C}{I_F} \times 100\%$

Typical Electrical/Optical Characteristic Curves (25°C Ambient Temperature Unless Otherwise Noted)

Fig.1 Forward Current vs. Ambient Temperature

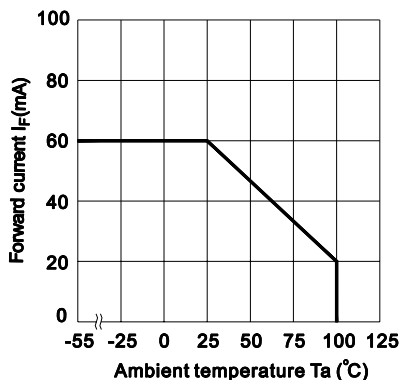

Fig.2 Collector Power Dissipation vs. Ambient Temperature

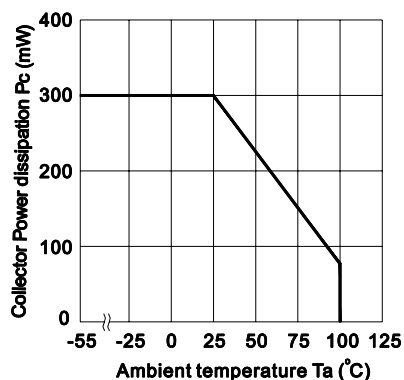

Fig.3 Forward Current vs. Forward Voltage

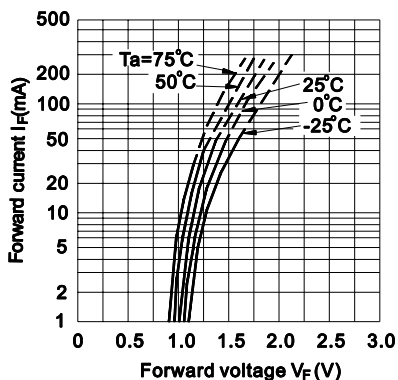

Fig.4 Current Transfer Ratio vs. Forward Current

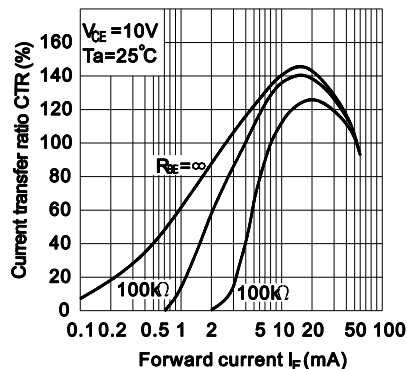

Fig.5 Collector Current vs. Collector-emitter Voltage

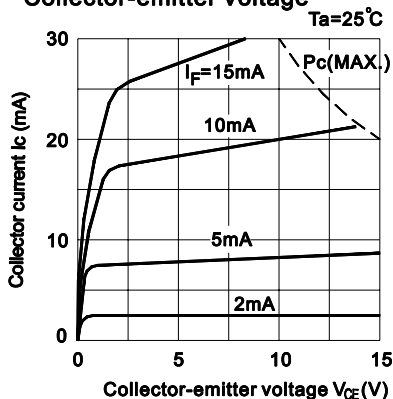
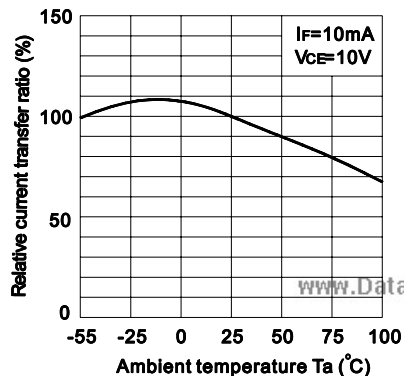

Fig.6 Relative Current Transfer Ratio vs. Ambient Temperature



PHOTOCOUPLER

Fig.7 Collector-emitter Saturation Voltage vs. Ambient Temperature

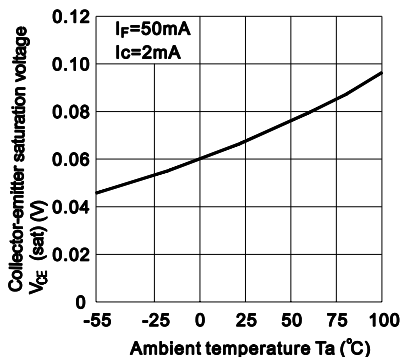

Fig.8 Collector Dark Current vs. Ambient Temperature

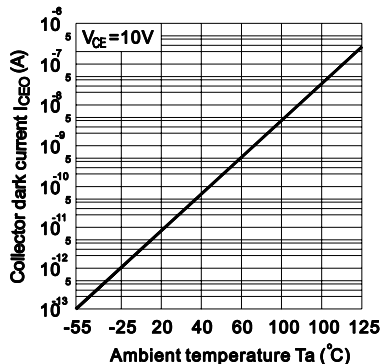

Fig.9 Response Time vs. Load Resistance

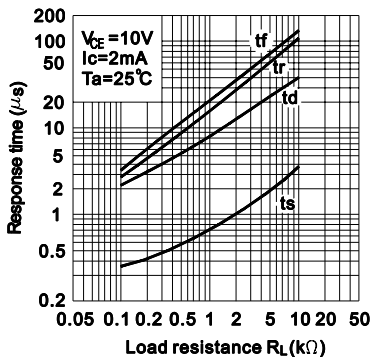

Fig.10 Frequency Response

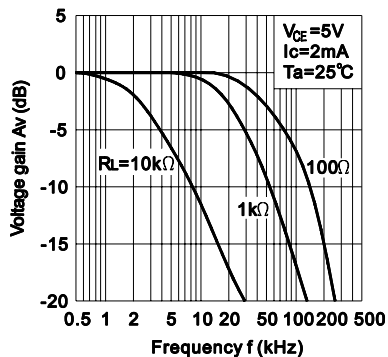
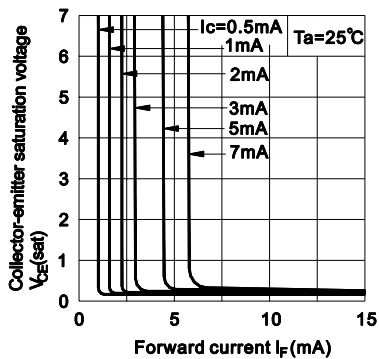
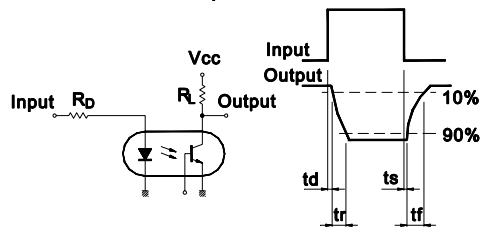

Fig.11 Collector-emitter Saturation Voltage vs. Forward Current



Test Circuit for Response Time



Test Circuit for Frequency Response

