

Surface Mount Multilayer Ceramic Chip Capacitors for Automotive Applications



FEATURES

- AEC-Q200 qualified with PPAP available
- Available in 0402 to 1812 body size
- Four dielectric materials
- AgPd termination available for silver epoxy bonding
- High operating temperature
- Wet build process
- Reliable Noble Metal Electrode (NME) system
- Halogen-free according to IEC 61249-2-21 definition
- Compliant to RoHS Directive 2002/95/EC

 AUTOMOTIVE
GRADE

RoHS
COMPLIANT
HALOGEN
FREE

For more than 20 years Vishay Vitramon has supported the automotive industry with robust, highly reliable MLCCs that have made it a leader in this segment. All Vishay Vitramon MLCCs are manufactured in "Precious Metal Technology" (PMT/NME) with a wet build process. They are qualified according to AEC-Q200 with PPAP available on request. Applications for these devices include automotive "under the hood", safety and comfort electronics. Their termination finish is 100 % tin plate matte and AgPd which is used with silver epoxy bonding. A Polymer (flexible) termination with 100 % tin plate matte finish is offered for intensive boardflex requirements.

COG (NP0) DIELECTRIC

GENERAL SPECIFICATION

Note

Electrical characteristics at + 25 °C unless otherwise specified

Operating Temperature: - 55 °C to + 150 °C
(above + 125 °C changed characteristics 2.3)

Capacitance Range: 1 pF to 22 nF

Voltage Range: 25 V_{DC} to 3000 V_{DC}

Temperature Coefficient of Capacitance (TCC):
0 ppm/°C ± 30 ppm/°C from - 55 °C to + 125 °C

Dissipation Factor (DF):

0.1 % maximum at 1.0 V_{RMS} and
1 MHz for values ≤ 1000 pF

0.1 % maximum at 1.0 V_{RMS} and
1 kHz for values > 1000 pF

Insulating Resistance:

At + 25 °C 100 000 MΩ min. or 1000 ΩF whichever is less
At + 125 °C 10 000 MΩ min. or 100 ΩF whichever is less

Aging: 0 % maximum per decade

Dielectric Strength Test:

Performed per method 103 of EIA 198-2-E.

Applied test voltages

≤ 250 V _{DC} -rated:	250 % of rated voltage
500 V _{DC} -rated:	200 % of rated voltage
630 V _{DC} , 1000 V _{DC} -rated:	150 % of rated voltage
3000 V _{DC} -rated:	120 % of rated voltage

X5R, X7R, X8R DIELECTRIC

GENERAL SPECIFICATION

Note

Electrical characteristics at + 25 °C unless otherwise specified

Operating Temperature: - 55 °C to + 150 °C
(X5R above + 85 °C changed characteristics 2.3)
(X7R above + 125 °C changed characteristics 2.3)

Capacitance Range: 120 pF to 1.0 μF

Voltage Range: 10 V_{DC} to 1000 V_{DC}

Temperature Coefficient of Capacitance (TCC):

X5R: ± 15 % from - 55 °C to + 85 °C, with 0 V_{DC} applied (5)
X7R: ± 15 % from - 55 °C to + 125 °C, with 0 V_{DC} applied
X8R: ± 15 % from - 55 °C to + 150 °C, with 0 V_{DC} applied

Dissipation Factor (DF):

10 V ratings: 5 % maximum at 1.0 V_{RMS} and 1 kHz
16 V, 25 V ratings: 3.5 % maximum at 1.0 V_{RMS} and 1 kHz
> 25 V ratings: 2.5 % maximum at 1.0 V_{RMS} and 1 kHz

Insulating Resistance:

At + 25 °C 100 000 MΩ min. or 1000 ΩF whichever is less
At + 125 °C 10 000 MΩ min. or 100 ΩF whichever is less

Aging Rate: 1 % maximum per decade

Dielectric Strength Test:

Performed per method 103 of EIA 198-2-E.

Applied test voltages

≤ 250 V _{DC} -rated:	250 % of rated voltage
500 V _{DC} -rated:	min. 150 % of rated voltage
630 V _{DC} , 1000 V _{DC} -rated:	150 % of rated voltage



QUICK REFERENCE DATA				
DIELECTRIC	CASE	MAXIMUM VOLTAGE (V)	CAPACITANCE	
			MINIMUM	MAXIMUM
C0G (NP0)	0402	100	1.0 pF	220 pF
	0603	200	1.0 pF	820 pF
	0805	500	1.0 pF	3.9 nF
	1206	630	1.0 pF	10 nF
	1210	630	100 pF	22 nF
	1812	3000	12 pF	22 nF
X5R	0805	10	560 nF	1.0 μF
X7R	0402	100	120 pF	47 nF
	0603	200	330 pF	150 nF
	0805	500	330 pF	470 nF
	1206	630	220 pF	1.0 μF
	1210	630	390 pF	1.0 μF
	1812	630	10 nF	1.0 μF
X8R	0603	50	470 pF	33 nF
	0805	50	470 pF	100 nF
	1206	50	10 nF	220 nF
	1210	50	10 nF	390 nF

Note

- Detail ratings see selection chart



ORDERING INFORMATION - TIN TERMINATION								
VJ0805 ⁽²⁾	Y	102	K	X	A	A	C	31
CASE CODE	DIELECTRIC	CAPACITANCE NOMINAL CODE	CAPACITANCE TOLERANCE	TERMINATION	DC VOLTAGE RATING ⁽¹⁾	MARKING	PACKAGING	PROCESS CODE
0402 0603 0805 1206 1210 1812	A = COG (NP0) Y = X7R G = X5R ⁽⁵⁾ H = X8R	Expressed in picofarads (pF). The first two digits are significant, the third is a multiplier. An "R" indicates a decimal point. Examples 4R7 = 4.7 pF 102 = 1000 pF	B = ± 0.10 pF C = ± 0.25 pF D = ± 0.5 pF F = ± 1 % G = ± 2 % J = ± 5 % K = ± 10 % M = ± 20 % Note: COG (NP0): B, C, D < 10 pF F, G, J, K ≥ 10 pF X5R/X7R/X8R: J, K, M	X = Ni barrier 100 % tin plate matte finish B = Polymer 100 % tin plate matte finish ⁽³⁾	Q = 10 V J = 16 V X = 25 V A = 50 V B = 100 V C = 200 V P = 250 V T = 400V ⁽⁴⁾ E = 500 V L = 630 V G = 1000 V H = 3000 V	A = Unmarked B = Marked Note: Marking is only available for 0805 and 1206 vendor ID and date code	E/T = 7" reel/plastic tape ⁽⁶⁾ C = 7" reel/paper tape M/R = 11 1/4"/13" reel/plastic tape ⁽⁶⁾ P = 11 1/4"/13" reel/paper tape	31 = Automotive 100 % tin plate matte finish

ORDERING INFORMATION - SILVER PALLADIUM TERMINATION								
VJ0805 ⁽²⁾	Y	102	K	F	A	A	O	34
CASE CODE	DIELECTRIC	CAPACITANCE NOMINAL CODE	CAPACITANCE TOLERANCE	TERMINATION	DC VOLTAGE RATING ⁽¹⁾	MARKING	PACKAGING	PROCESS CODE
0402 0603 0805 1206 1210 1812	A = COG (NP0) Y = X7R G = X5R ⁽⁵⁾ H = X8R	Expressed in picofarads (pF). The first two digits are significant, the third is a multiplier. An "R" indicates a decimal point. Examples 102 = 1000 pF	B = ± 0.10 pF C = ± 0.25 pF D = ± 0.5 pF F = ± 1 % G = ± 2 % J = ± 5 % K = ± 10 % M = ± 20 % Note: COG (NP0): B, C, D < 10 pF F, G, J, K ≥ 10 pF X5R/X7R/X8R: J, K, M	F, E = AgPd ⁽⁷⁾	Q = 10 V J = 16 V X = 25 V A = 50 V B = 100 V C = 200 V P = 250 V T = 400V ⁽⁴⁾ E = 500 V L = 630 V G = 1000 V H = 3000 V	A = Unmarked Note: Marking is not available	E/T = 7" reel/plastic tape ⁽⁶⁾ O = 7" reel/flamed paper tape M/R = 11 1/4"/13" reel/plastic tape ⁽⁶⁾ I = 11 1/4"/13" reel/flamed paper tape Note: "I" and "O" are used for "F", "E" termination size 0402/0603/0805	34 = Automotive AgPd finish

Notes

- (1) DC voltage rating should not be exceeded in application. Other application factors may affect the MLCC performance. Consult for questions: mlcc@vishay.com
- (2) Case size designator may be replaced by a four digit drawing number
- (3) Polymer termination contact mlcc@vishay.com for availability of ratings
- (4) Per customer request. Contact: mlcc@vishay.com for availability
- (5) Selected values for X5R, see dielectric selection chart
- (6) Packaging "T" and "R" is used for 1812 size
- (7) Termination code "E" is for conductive epoxy assembly.

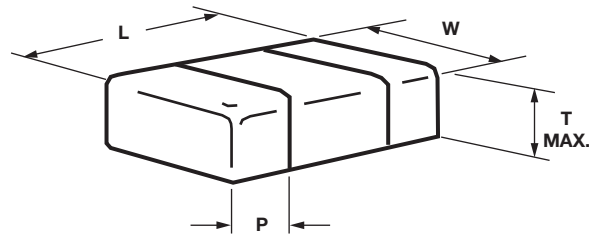
DIMENSIONS in inches (millimeters)

EIA CODE	STYLE	LENGTH (L)	WIDTH (W)	MAXIMUM THICKNESS (T)	TERMINATIONS PAD (P)	
					MINIMUM	MAXIMUM
0402	VJ0402	0.040 + 0.004/- 0.002 (1.00 + 0.10/- 0.05)	0.020 + 0.004/- 0.002 (0.50 + 0.10/- 0.05)	0.024 (0.60)	0.004 (0.10)	0.016 (0.41)
0603	VJ0603	0.063 ± 0.005 (1.60 ± 0.12)	0.031 ± 0.005 (0.80 ± 0.12)	0.038 (0.97)	0.012 (0.30)	0.018 (0.46)
0805	VJ0805	0.079 ± 0.008 (2.00 ± 0.20)	0.049 ± 0.008 (1.25 ± 0.20)	0.057 (1.45)	0.010 (0.25)	0.028 (0.71)
1206	VJ1206	0.126 ± 0.008 (3.20 ± 0.25)	0.063 ± 0.010 (1.60 ± 0.25)	0.067 (1.70)	0.010 (0.25)	0.028 (0.71)
1210	VJ1210	0.126 ± 0.010 (3.20 ± 0.25)	0.098 ± 0.010 (2.50 ± 0.25)	0.076 (1.94)	0.010 (0.25)	0.028 (0.71)
1812	VJ1812	0.177 ± 0.010 (4.50 ± 0.25)	0.126 ± 0.010 (3.20 ± 0.25)	0.086 (2.18)	0.010 (0.25)	0.030 (0.76)

Note

- Polymer (B-termination) have increased dimensions:
Length 0.006" (0.15 mm)



SELECTION CHART										
DIELECTRIC		COG (NP0)								
STYLE		VJ0402		VJ0603			VJ0805			
EIA CODE		0402		0603			0805			
VOLTAGE (V _{DC})		25/50	100	50	100	200	50	100	200	500
VOLTAGE CODE		X/A	B	A	B	C	A	B	C	E
CAP. CODE	CAP.									
1R0	1.0 pF	••	••	••	••	••	••	••	••	••
1R2	1.2 pF	••	••	••	••	••	••	••	••	••
1R5	1.5 pF	••	••	••	••	••	••	••	••	••
1R8	1.8 pF	••	••	••	••	••	••	••	••	••
2R2	2.2 pF	••	••	••	••	••	••	••	••	••
2R7	2.7 pF	••	••	••	••	••	••	••	••	••
3R3	3.3 pF	••	••	••	••	••	••	••	••	••
3R9	3.9 pF	••	••	••	••	••	••	••	••	••
4R7	4.7 pF	••	••	••	••	••	••	••	••	••
5R6	5.6 pF	••	••	••	••	••	••	••	••	••
6R8	6.8 pF	••	••	••	••	••	••	••	••	••
8R2	8.2 pF	••	••	••	••	••	••	••	••	••
100	10 pF	••	••	••	••	••	••	••	••	••
120	12 pF	••	••	••	••	••	••	••	••	••
150	15 pF	••	••	••	••	••	••	••	••	••
180	18 pF	••	••	••	••	••	••	••	••	••
220	22 pF	++	++	••	••	••	••	••	••	••
270	27 pF	++	++	••	••	••	••	••	••	••
330	33 pF	++	++	••	••	••	••	••	••	••
390	39 pF	++	++	••	••	••	••	••	••	••
470	47 pF	++	++	••	••	••	••	••	••	••
560	56 pF	++	++	++	++	++	••	••	••	••
680	68 pF	++	++	++	++	++	••	••	••	••
820	82 pF	++	++	++	++	++	••	••	••	••
101	100 pF	++	++	++	++	++	++	++	++	++
121	120 pF	++	++	++	++	++	++	++	++	++
151	150 pF	++		++	++	++	++	++	++	++
181	180 pF	++		++	++	+	++	++	++	++
221	220 pF	++		++	++	+	++	++	++	+
271	270 pF			++	++	+	++	++	++	+
331	330 pF			++	++		++	++	++	+
391	390 pF			++	++		++	++	++	+
471	470 pF			++	++		++	++	+	+
561	560 pF			++			++	++	+	
681	680 pF			++			++	++	+	
821	820 pF			+			++	++	+	
102	1.0 nF						++	++	+	
122	1.2 nF						++	+		
152	1.5 nF						++	+		
182	1.8 nF						+	+		
222	2.2 nF						+			
242	2.4 nF									
272	2.7 nF						+			
332	3.3 nF						+			
392	3.9 nF						+			
472	4.7 nF									
562	5.6 nF									
682	6.8 nF									
822	8.2 nF									
103	10 nF									
123	12 nF									
153	15 nF									
183	18 nF									
223	22 nF									
273	27 nF									
333	33 nF									
393	39 nF									
473	47 nF									
563	56 nF									

Notes

•• Paper tape, • Plastic tape, ++ Paper tape, + Plastic tape, see table "Product drawings (in use)"
 (1) See soldering recommendations within this data book, or visit www.vishay.com/doc?45034



SELECTION CHART																
DIELECTRIC		COG (NP0)														
STYLE		VJ1206 ⁽¹⁾					VJ1210 ⁽¹⁾					VJ1812 ⁽¹⁾				
EIA CODE		1206 ⁽¹⁾					1210 ⁽¹⁾					1812 ⁽¹⁾				
VOLTAGE (V _{DC})		50	100	200	250	500/630	50	100	200	500/630	50	100	200	500/630	1000	3000
VOLTAGE CODE		A	B	C	P	E/L	A	B	C	E/L	A	B	C	E/L	G	H
CAP. CODE	CAP.															
1R0	1.0 pF	••	••	••		••										
1R2	1.2 pF	••	••	••		••										
1R5	1.5 pF	••	••	••		••										
1R8	1.8 pF	••	••	••		••										
2R2	2.2 pF	••	••	••		••										
2R7	2.7 pF	••	••	••		••										
3R3	3.3 pF	••	••	••		••										
3R9	3.9 pF	••	••	••		••										
4R7	4.7 pF	••	••	••		••										
5R6	5.6 pF	••	••	••		••										
6R8	6.8 pF	••	••	••		••										
8R2	8.2 pF	••	••	••		••										
100	10 pF	••	••	••		••										
120	12 pF	••	••	••		••										•
150	15 pF	••	••	••		••										•
180	18 pF	••	••	••		••										•
220	22 pF	••	••	••		••									•	•
270	27 pF	••	••	••		••									•	•
330	33 pF	••	••	••		••									•	•
390	39 pF	••	••	••		••					•	•	•	•	•	•
470	47 pF	••	••	••		••					•	•	•	•	•	•
560	56 pF	••	••	••		••					•	•	•	•	•	•
680	68 pF	••	••	••		••					•	•	•	•	•	•
820	82 pF	••	••	••		••					•	•	•	•	•	•
101	100 pF	+	+	+		+	+	+	+	+	•	•	•	•	•	•
121	120 pF	+	+	+		+	+	+	+	+	•	•	•	•	•	•
151	150 pF	+	+	+		+	+	+	+	+	•	•	•	•	•	•
181	180 pF	+	+	+		+	+	+	+	+	•	•	•	•	•	•
221	220 pF	+	+	+		+	+	+	+	+	•	•	•	•	•	•
271	270 pF	+	+	+		+	+	+	+	+	•	•	•	•	•	•
331	330 pF	+	+	+		+	+	+	+	+	•	•	•	•	•	•
391	390 pF	+	+	+		+	+	+	+	+	•	•	•	•	•	•
471	470 pF	+	+	+		+	+	+	+	+	•	•	•	•	•	•
561	560 pF	+	+	+		+	+	+	+	+	•	•	•	•	•	•
681	680 pF	+	+	+		+	+	+	+	+	•	•	•	•	•	•
821	820 pF	+	+	+		+	+	+	+	+	•	•	•	•	•	•
102	1.0 nF	+	+	+		+	+	+	+	+	•	•	•	•	•	•
122	1.2 nF	+	+	+		+	+	+	+	+	•	•	•	•	•	•
152	1.5 nF	+	+	+		+	+	+	+	+	•	•	•	•	•	•
182	1.8 nF	+	+	+		+	+	+	+	+	•	•	•	•	•	•
222	2.2 nF	+	+	+	+	+	+	+	+	+	•	•	•	•	•	•
242	2.4 nF		+													
272	2.7 nF	+	+	+			+	+	+		•	•	•	•		
332	3.3 nF	+	+	+			+	+	+		•	•	•	•		
392	3.9 nF	+	+				+	+	+		•	•	•	•		
472	4.7 nF	+	+				+	+	+		•	•	•	•		
562	5.6 nF	+	+				+	+	+		•	•	•	•		
682	6.8 nF	+	+				+	+	+		•	•	•	•		
822	8.2 nF	+	+				+	+	+		•	•	•	•		
103	10 nF	+	+				+	+			•	•	•			
123	12 nF						+	+			•	•	•			
153	15 nF						+	+			•	•				
183	18 nF						+	+			•					
223	22 nF						+				•					
273	27 nF															
333	33 nF															
393	39 nF															
473	47 nF															
563	56 nF															

Notes

•• Paper tape, • Plastic tape, ++ Paper tape, + Plastic tape, see table "Product drawings (in use)"

⁽¹⁾ See soldering recommendations within this data book, or visit www.vishay.com/doc?45034



SELECTION CHART																		
DIELECTRIC		X7R																
STYLE		VJ0402				VJ0603					VJ0805 ⁽²⁾							
EIA CODE		0402				0603					0805							
VOLTAGE (V _{DC})		16	25	50	100	16	25	50	100	200	10	16	25	50	100	200	250	500
VOLTAGE CODE		J	X	A	B	J	X	A	B	C	Q	J	X	A	B	C	P	E
CAP. CODE	CAP.																	
121	120 pF	**	**	**	**													
151	150 pF	**	**	**	**													
181	180 pF	**	**	**	**													
221	220 pF	**	**	**	**													
271	270 pF	**	**	**	**													
331	330 pF	**	**	**	**			**	**	**		**	**	**	**	**		
391	390 pF	**	**	**	**	**	**	**	**	**		**	**	**	**	**	**	
471	470 pF	**	**	**	**	**	**	**	**	**		**	**	**	**	**	**	
561	560 pF	**	**	**	**	**	**	**	**	**		**	**	**	**	**	**	
681	680 pF	**	**	**	**	**	**	**	**	**		**	**	**	**	**	**	
821	820 pF	**	**	**	**	**	**	**	**	**		**	**	**	**	**	**	
102	1.0 nF	**	**	**	**	**	**	**	**	**		**	**	**	**	**	**	
122	1.2 nF	**	**	**	**	**	**	**	**	**		**	**	**	**	**	**	
152	1.5 nF	**	**	**	**	**	**	**	**	**		**	**	**	**	**	**	
182	1.8 nF	**	**	**	**	**	**	**	**	**		**	**	**	**	**	**	
222	2.2 nF	**	**	**	**	**	**	**	**	**		**	**	**	**	**	**	
272	2.7 nF	**	**	**	++	**	**	**	**	**		**	**	**	**	**	**	
332	3.3 nF	**	**	**	++	**	**	**	**	**		**	**	**	**	**	**	•
392	3.9 nF	**	**	**	++	**	**	**	**	**		**	**	**	**	**	**	
472	4.7 nF	**	**	**	++	**	**	**	**	**		**	**	**	**	**	**	
562	5.6 nF	**	**	++		**	**	**	**	**		**	**	**	**	**	**	
682	6.8 nF	**	**	++		**	**	**	**	**		**	**	**	**	**	**	
822	8.2 nF	**	**	++		**	**	**	**	**		**	**	**	**	**	**	
103	10 nF	++	++	++		**	**	**	**	**		**	**	**	**	**	**	**
123	12 nF	++	++			**	**	**	++	**		**	**	**	**	**	•	
153	15 nF	++	++			**	**	**	++	**		**	**	**	**	**	•	
183	18 nF	++	++			**	**	**	++	**		**	**	**	**	**	•	
223	22 nF	++				**	**	**	++	**		**	**	**	**	**	•	
273	27 nF	++				**	**	**	++	**		**	**	**	**	**	•	
333	33 nF	++				**	**	++	++	**		**	**	**	•			
393	39 nF	++				**	**	++	++	**		**	**	**	•			
473	47 nF	++				**	**	++		**		**	**	**	•			
563	56 nF					**	++	++		**		**	**	**	+			
683	68 nF					**	++	++		**		+	+	+	+			
823	82 nF					**	++	++		**		+	+	+	+			
104	100 nF					++	++	++		**		+	+	+	+			
124	120 nF					++				**		+	+	+				
154	150 nF					++				**		+	+	+				
184	180 nF									**		+	+					
224	220 nF									**		+	+					
274	270 nF									**		+	+					
334	330 nF									**		+	+					
394	390 nF									**		+						
474	470 nF									**		+						
564	560 nF									**								
684	680 nF									**								
824	820 nF									**								
105	1.0 µF									**								
125	1.2 µF									**								
155	1.5 µF									**								
185	1.8 µF									**								
225	2.2 µF									**								
275	2.7 µF									**								
335	3.3 µF									**								
395	3.9 µF									**								
475	4.7 µF									**								
565	5.6 µF									**								
685	6.8 µF									**								

Notes

** Paper tape, • Plastic tape, ++ Paper tape, + Plastic tape, see table "Product drawings (in use)"

(1) See soldering recommendations within this data book, or visit www.vishay.com/doc?45034

(2) X5R (- 55 °C to + 85 °C TCC: ± 15 %) for all 0805/10 V ratings



SELECTION CHART																		
DIELECTRIC		X7R																
STYLE		VJ1206						VJ1210 ⁽¹⁾						VJ1812 ⁽¹⁾				
EIA CODE		1206 ⁽¹⁾						1210 ⁽¹⁾						1812 ⁽¹⁾				
VOLTAGE (V _{DC})		16	25	50	100	200	500/630	16	25	50	100	200	500/630	50	100	200	500	630
VOLTAGE CODE		J	X	A	B	C	E/L	J	X	A	B	C	E/L	A	B	C	E	L
CAP. CODE	CAP.																	
121	120 pF																	
151	150 pF																	
181	180 pF																	
221	220 pF						•											
271	270 pF						•											
331	330 pF						•											
391	390 pF						•						•					
471	470 pF						•						•					
561	560 pF						•						•					
681	680 pF						•						•					
821	820 pF			•	•	•	•						•					
102	1.0 nF	•	•	•	•	•	•						•					
122	1.2 nF	•	•	•	•	•	•						•					
152	1.5 nF	•	•	•	•	•	•						•					
182	1.8 nF	•	•	•	•	•	•						•					
222	2.2 nF	•	•	•	•	•	•					•	•					
272	2.7 nF	•	•	•	•	•	•					•	•					
332	3.3 nF	•	•	•	•	•	•					•	•					
392	3.9 nF	•	•	•	•	•	•					•	•					
472	4.7 nF	•	•	•	•	•	•					•	•					
562	5.6 nF	•	•	•	•	•	•					•	•					
682	6.8 nF	•	•	•	•	•	•					•	•					
822	8.2 nF	•	•	•	•	•	•					•	•					
103	10 nF	•	•	•	•	•	•	•	•	•	•	•	•			•	•	•
123	12 nF	•	•	•	•	•	•	•	•	•	•	•	•			•	•	•
153	15 nF	•	•	•	•	•	•	•	•	•	•	•	•			•	•	•
183	18 nF	•	•	•	•	•	•	•	•	•	•	•	•			•	•	•
223	22 nF	•	•	•	•	•	•	•	•	•	•	•	•	•	•	•	•	•
273	27 nF	•	•	•	•	•	•	•	•	•	•	•	•	•	•	•	•	•
333	33 nF	•	•	•	•	•	•	•	•	•	•	•	•	•	•	•	•	•
393	39 nF	•	•	•	•	•	•	•	•	•	•	•	•	•	•	•	•	•
473	47 nF	•	•	•	•	•	•	•	•	•	•	•	•	•	•	•	•	•
563	56 nF	•	•	•	•	•	•	•	•	•	•	•	•	•	•	•	•	•
683	68 nF	•	•	•	•	•	•	•	•	•	•	•	•	•	•	•	•	•
823	82 nF	•	•	•	•	•	•	•	•	•	•	•	•	•	•	•	•	•
104	100 nF	•	•	•	+	+		•	•	•	+	+		•	•	•	•	
124	120 nF	•	•	•	+	+		•	•	•	+	+		•	•	•	•	
154	150 nF	•	•	+	+			•	•	•	+	+		•	•	•	•	
184	180 nF	•	•	+	+			•	•	•	+	+		•	•	•	•	
224	220 nF	+	+	+	+			+	+	+	+			•	•	•	•	
274	270 nF	+	+	+	+			+	+	+	+			•	•	•	•	
334	330 nF	+	+	+				+	+	+	+			•	•	•	•	
394	390 nF	+	+	+				+	+	+	+			•	•	•	•	
474	470 nF	+	+	+				+	+	+	+			•	+	•	•	
564	560 nF	+	+					+	+	+				•	+	•	•	
684	680 nF	+	+					+	+	+				•	+	•	•	
824	820 nF	+	+					+	+	+				+	+	•	•	
105	1.0 μF	+	+					+	+	+				+				
125	1.2 μF																	
155	1.5 μF																	
185	1.8 μF																	
225	2.2 μF																	
275	2.7 μF																	
335	3.3 μF																	
395	3.9 μF																	
475	4.7 μF																	
565	5.6 μF																	
685	6.8 μF																	

Notes

•• Paper tape, • Plastic tape, ++ Paper tape, + Plastic tape, see table "Product drawings (in use)"

⁽¹⁾ See soldering recommendations within this data book, or visit www.vishay.com/doc?45034



SELECTION CHART									
DIELECTRIC		X8R							
STYLE		VJ0603		VJ0805		VJ1206		VJ1210 ⁽¹⁾	
EIA CODE		0603		0805		1206		1210 ⁽¹⁾	
VOLTAGE (V _{DC}) ⁽²⁾		25	50	25	50	25	50	25	50
VOLTAGE CODE		X	A	X	A	X	A	X	A
CAP. CODE	CAP.								
101	100 pF								
121	120 pF								
151	150 pF								
181	180 pF								
221	220 pF								
271	270 pF								
331	330 pF								
391	390 pF								
471	470 pF		••	••	••				
561	560 pF		••	••	••				
681	680 pF	••	••	••	••				
821	820 pF	••	••	••	••				
102	1.0 nF	••	••	••	••	•	•		
122	1.2 nF	••	••	••	••	•	•		
152	1.5 nF	••	••	••	••	•	•		
182	1.8 nF	••	••	••	••	•	•		
222	2.2 nF	••	••	••	••	•	•		
272	2.7 nF	••	••	••	••	•	•		
332	3.3 nF	••	••	••	••	•	•		
392	3.9 nF	••	••	••	••	•	•		
472	4.7 nF	••	••	••	••	•	•		
562	5.6 nF	••	••	••	••	•	•		
682	6.8 nF	••	••	••	••	•	•		
822	8.2 nF	••	••	••	••	•	•		
103	10 nF	••	••	••	••	•	•	•	•
123	12 nF	••	••	••	••	•	•	•	•
153	15 nF	••	••	••	••	•	•	•	•
183	18 nF	••	••	••	••	•	•	•	•
223	22 nF	••		••	••	•	•	•	•
273	27 nF	••		••	•	•	•	•	•
333	33 nF	••		••	•	•	•	•	•
393	39 nF			••	•	•	•	•	•
473	47 nF			•	•	•	•	•	•
563	56 nF			•	•	•	•	•	•
683	68 nF			•	•	•	•	•	•
823	82 nF			•	•	•	•	•	•
104	100 nF			•		•	•	•	•
124	120 nF					•	•	•	•
154	150 nF					•		•	•
184	180 nF					•		•	•
224	220 nF					•		•	•
274	270 nF							•	•
334	330 nF							•	•
394	390 nF							•	
474	470 nF								
564	560 nF								
684	680 nF								
824	820 nF								
105	1.0 μF								
125	1.2 μF								

Notes

•• Paper tape, • Plastic tape

⁽¹⁾ See soldering recommendations within this data book, or visit www.vishay.com/doc?45034

⁽²⁾ For other voltage ratings, please contact mlcc@vishay.com



PRODUCT DRAWING (in use)					
SIZE	CODE	X - TERMINATION CODE (100 % MATTE TIN)		F - TERMINATION CODE (AgPd)	
		DRAWING C0G (NP0)	DRAWING X7R	DRAWING C0G (NP0)	DRAWING X7R
0402	•• = Paper tape	7175	9172	7175	9072
	++ = Paper tape	7172	7172	7072	7072
0603	•• = Paper tape	7179	9155	7179	9097
	++ = Paper tape	7155	7155	7097	7097
	• = Plastic tape	-	-	7179	9097
	+ = Plastic tape	7155	7155	7097	7097
0805	•• = Paper tape	7188	9156	7188	9080
	++ = Paper tape	7156	7156	7080	7080
	• = Plastic tape	-	9156	7188	9080
	+ = Plastic tape	7156	7156	7080	7080
1206	•• = Paper tape	7180	-	-	-
	• = Plastic tape	-	9157	7180	9081
	+ = Plastic tape	7157	7157	7081	7081
1210	• = Plastic tape	-	9158	-	9099
	+ = Plastic tape	7158	7158	7099	7099

STANDARD PACKAGING QUANTITIES (1)(2)					
BODY SIZE	TAPE SIZE	7" REEL QUANTITIES		11 1/4" AND 13" REEL QUANTITIES	
		PAPER TAPE PACKAGING CODE "C"/"O" (4)	PLASTIC TAPE PACKAGING CODE "E"/"T" (6)	PAPER TAPE PACKAGING CODE "P"/"I" (4)	PLASTIC TAPE PACKAGING CODE "M"/"R" (6)
0402	8 mm	5000/10 000 (3)	n/a	10 000/30 000 (3)	n/a
0603	8 mm	4000	n/a	10 000	n/a
0805 (5)	8 mm	3000	3000	10 000	10 000
1206 (5)	8 mm	n/a	3000	n/a	10 000
1210 (5)	8 mm	n/a	2000/2500/3000	n/a	9000/10 000
1812	12 mm	n/a	1000	n/a	4000

Notes

- (1) Reference: EIA standard RS 481 - "Taping of Surface Mount Components for Automatic Placement"
- (2) n/a = Not available
- (3) Quantity can vary with customer request
- (4) Flamed paper tape code "O" (7" reel) and "I" (11 1/4/13" reel) for AgPd terminated parts (termination code F, E)
- (5) Packaging "C/P" or "E/M" and quantity can depend from product thickness
- (6) Packaging code "T", "R" are used for size 1812.

**1 - GENERAL CERTIFICATES**

# Quality management system acc. to ISO/TS 16949: 2009	Yes
# Quality management system acc. to ISO 9001: 2008	Yes
# Environmental certification acc. to ISO 14001: 2004	Yes
# Health and safety system acc. to OHSAS 18001	Yes

2 - TECHNICAL REQUIREMENTS

Unless specified in component specification, these parameters are the minimum requirements for the components.

2.1 OPERATING TEMPERATURE RANGE

For standard applications	T _A : - 55 °C to + 125 °C	see characteristics 2.3
For high temperature applications	T _A : - 55 °C to + 150 °C	see characteristics 2.3
For ultra high temperature applications	T _A : - 55 °C to + 175 °C	see characteristics 2.3

2.2 STORAGE AND HANDLING CONDITIONS

- (1) Store the components at 5 °C to + 40 °C ambient temperature and ≤ 70 % related humidity conditions.
(2) The product is recommended to be used within a time-frame of 2 years after shipment.
Check solderability in case extended shelf life beyond the expiry date is needed.

Precautions:

- Do not store products in an environment containing corrosive elements, especially where chloride gas, sulfide gas, acid, alkali, salt or the like are present. This may cause corrosion or oxidization of the terminations, which can easily lead to poor soldering.
- Store products on the shelf and avoid exposure to moisture or dust.
- Do not expose products to excessive shock, vibration, direct sunlight and so on.

2.3 CHARACTERISTICS

PARAMETER	CERAMIC TYPE	SYMBOL	RATINGS	TEST CONDITIONS/ REMARKS
Rated voltage in temperature range - 55 °C to + 85 °C	X5R	U _R	10 V	
Rated voltage in temperature range - 55 °C to + 125 °C	C0G (NP0)	U _R	25 V to 3000 V	
	X7R		16 V to 630 V	
Rated voltage in temperature range - 55 °C to + 150 °C	X8R		25 V/50 V	
Derating at higher temperature up to + 150 °C	C0G (NP0),		25 V to 100 V	U _{DC} ≤ 1/2 U _R
	X7R		16 V to 100 V	U _{DC} ≤ 1/2 U _R
Derating at higher temperature up to + 175 °C	C0G (NP0),		25 V to 100 V	U _{DC} ≤ 1/4 U _R
	X7R	16 V to 100 V	U _{DC} ≤ 1/4 U _R	
	X8R	25 V/50 V	U _{DC} ≤ 1/4 U _R	
Temperature coefficient in temperature range - 55 °C to + 125 °C	C0G (NP0)	α _C	≤ ± 30 ppm/°C	if C _R < 10 pF: α _C ≤ ± 120 ppm/K
	X7R	ΔC	≤ ± 15 %	
Temperature coefficient in temperature range - 55 °C to + 150 °C	C0G (NP0)	α _C	≤ ± 30 ppm/°C	if C _R < 10 pF: α _C ≤ ± 120 ppm/K
	X7R	ΔC	+ 15 %/- 30 %	
	X8R		≤ ± 15 %	
Temperature coefficient in temperature range - 55 °C to + 175 °C	X7R	ΔC	+ 15 %/- 50 %	
Dissipation factor in temperature range - 55 °C to + 175 °C	C0G (NP0)	tan δ	≤ 0.0015	
	X7R		≤ 0.06	
	X8R		≤ 0.06	



COG (NP0) DIELECTRIC - TYPICAL PARAMETERS

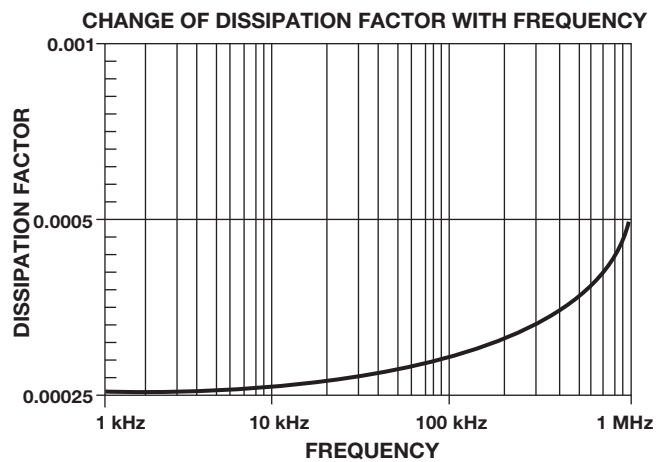
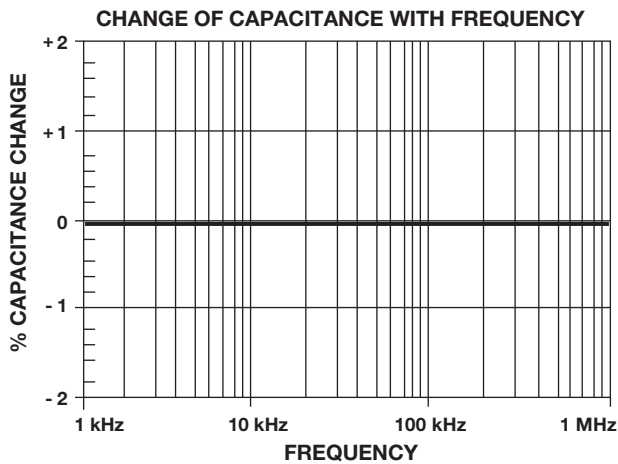
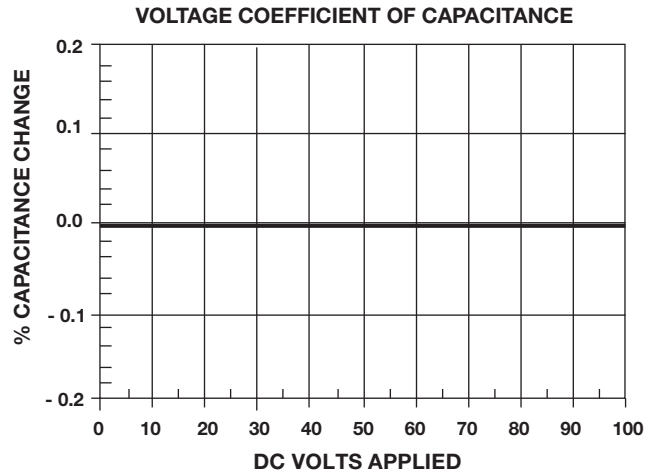
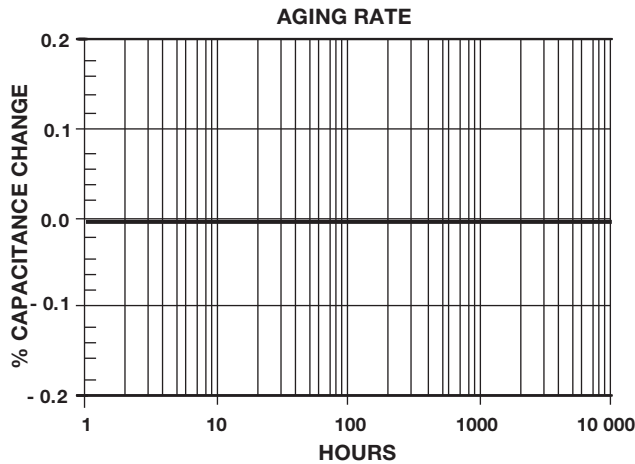
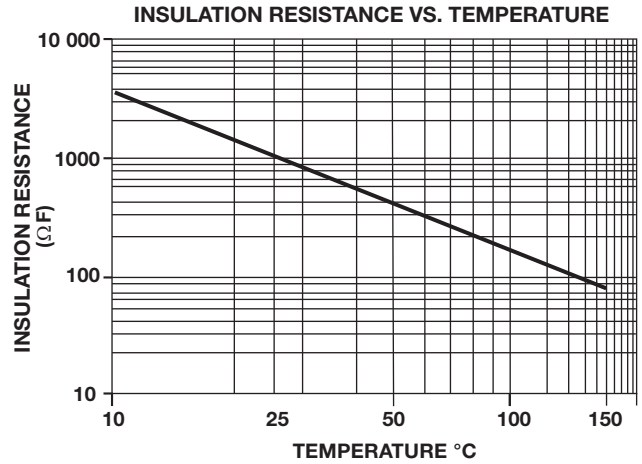
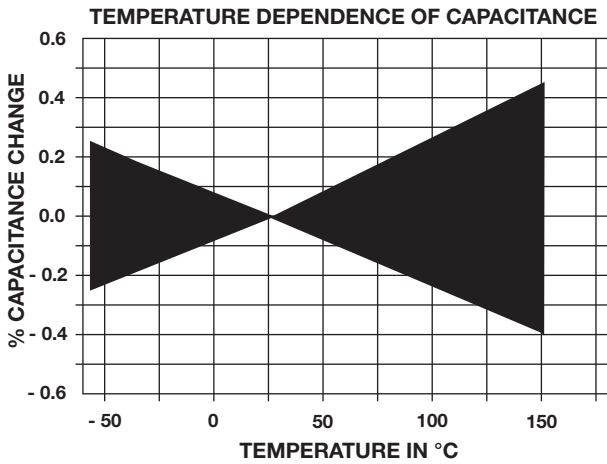



X7R DIELECTRIC - TYPICAL PARAMETERS

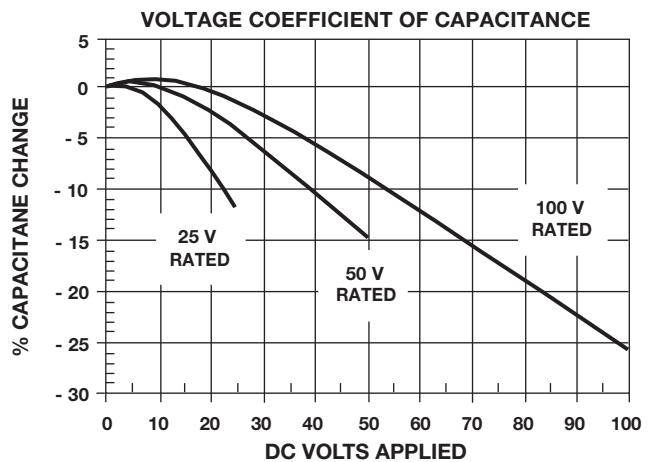
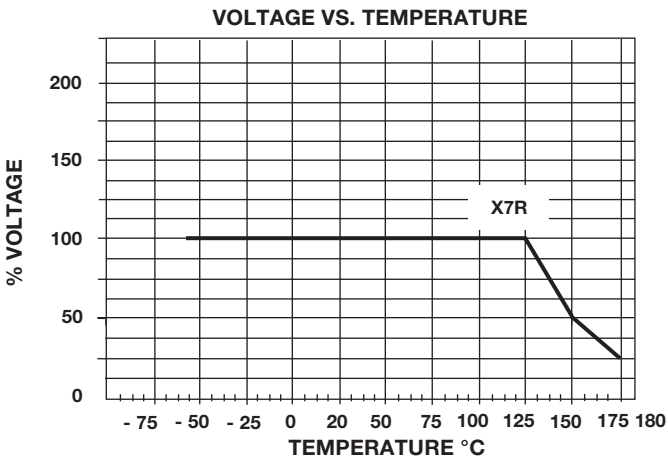
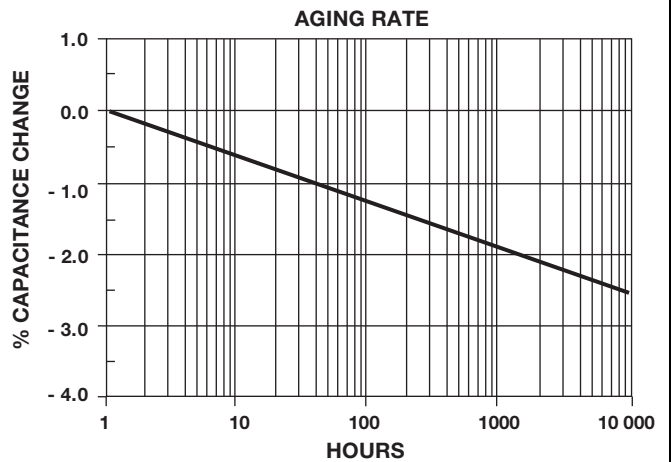
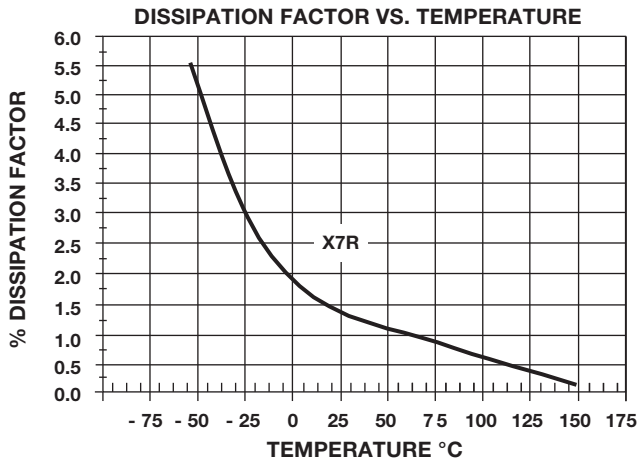
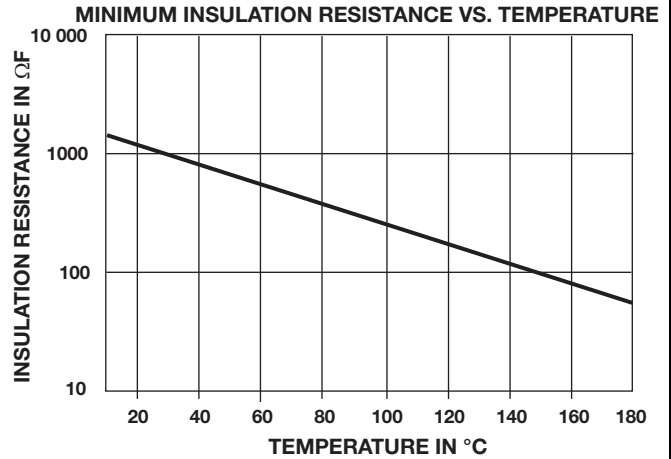
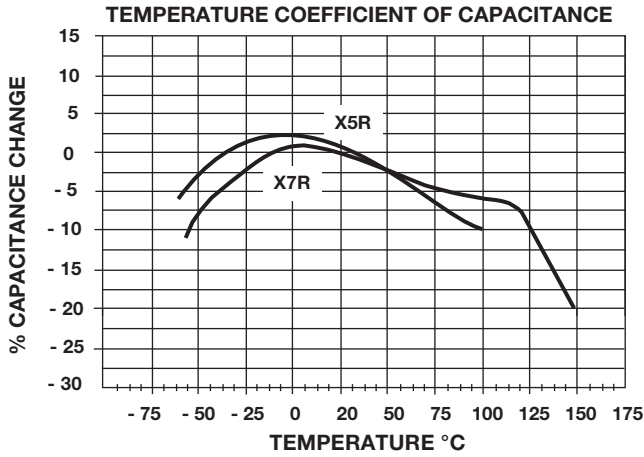



X7R DIELECTRIC - TYPICAL PARAMETERS

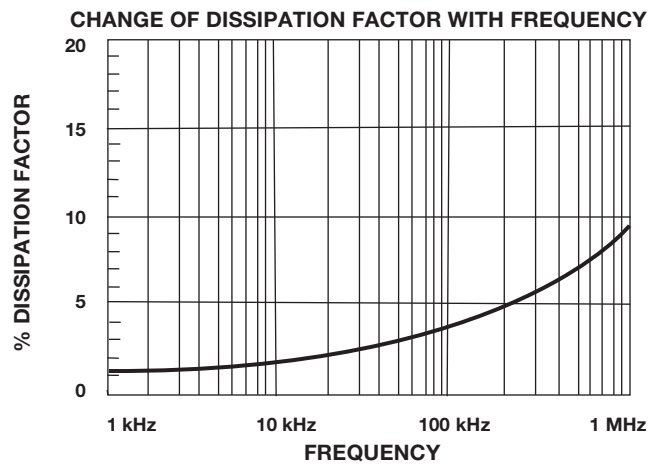
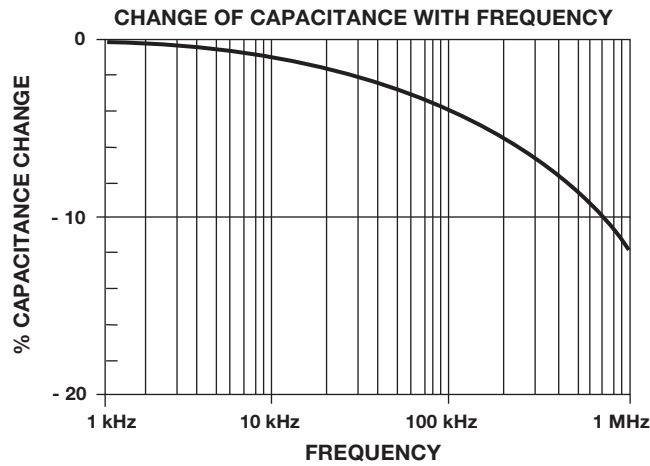
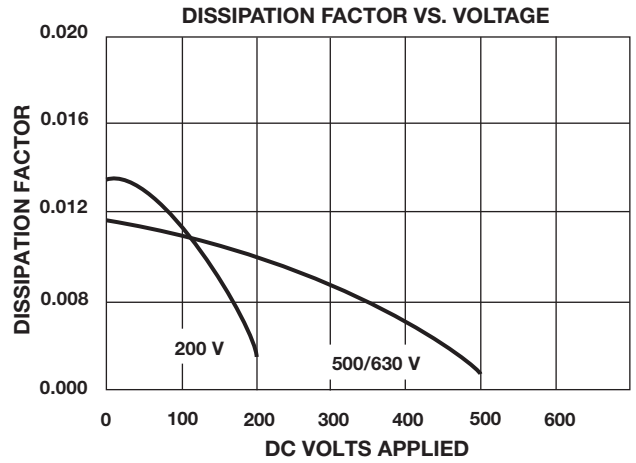
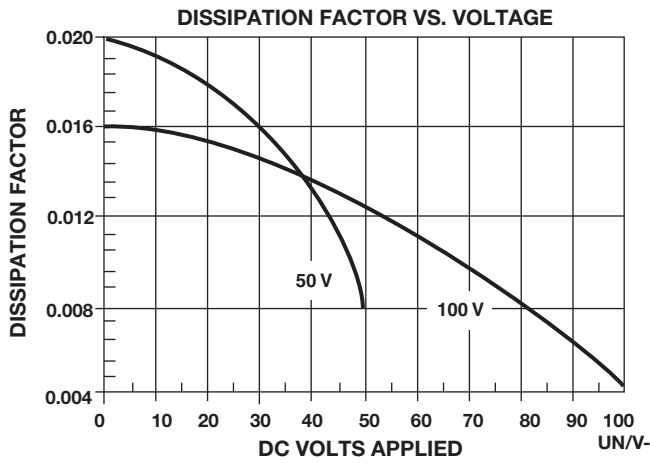



X8R DIELECTRIC - TYPICAL PARAMETERS

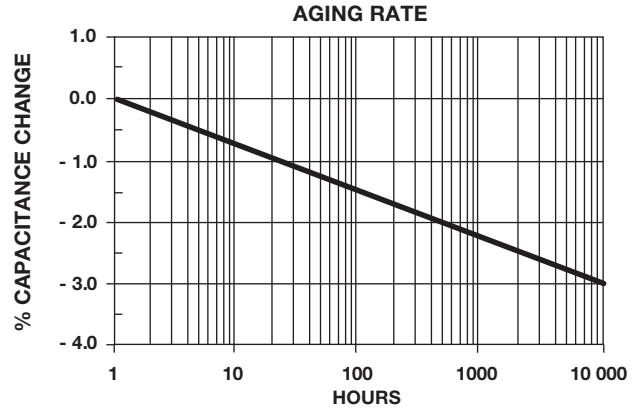
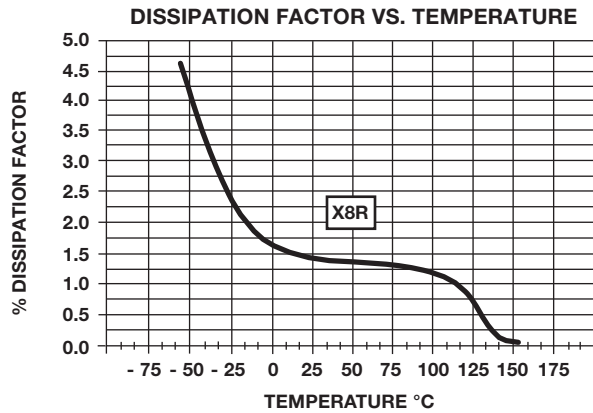
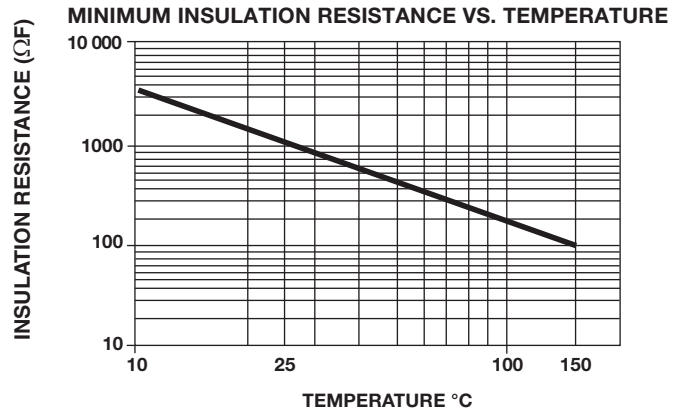
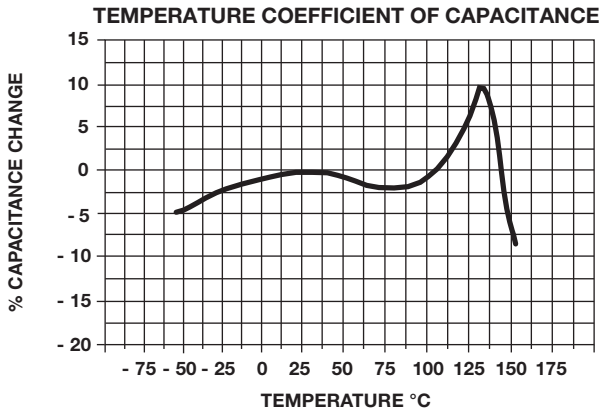



3 - LOT ACCEPTANCE TESTS

Process tests available in classes (on request)

GROUP	ACTION
A	Components are tested within the monitoring program of the supplier. The supplier shall submit the part numbers of the selected component to the customer during the component specification discussions.
B	Components (customer P/N) shall be tested quarterly. Records available only on special request by the customer.
C	Test with each shipment. Records are provided on a monthly basis. Customer special requirement; requirement should be determined in a specific component specification.

Upon request the records can be submitted in electronic format on monthly basis.

3.1 THERMAL STRENGTH, THERMAL SHOCK SENSIBILITY

Sample size	200
Handling	Mounted on PCB
Thermal shock	1 x 280 °C, no pre-heat, 5 s to 10 s
IR - test (IRATS)	U = U _R , T = room temperature, verified
Burn in (BIATS)	Equivalent to 12 h burn-in, 2 x U _R /125 °C, verification time to failure

Acceptance criteria: Zero defects (IRATS and BIATS).

3.2 BOARD FLEX TEST

Sample size	20 pcs/lot
X5R, X7R, X8R	Every lot
C0G	At least three different part numbers of one component family matrix per quarter
Max. deflection	8 mm (data to be reported, available on request)

3.3 SOLDERABILITY/RESISTANCE TO SOLDERING HEAT

Temperature profile for reflow soldering of SMD parts IPC/JEDEC-J-STD-020C.

Test is done on a regular basis for samples taken randomly out of the line.

Acceptance criteria: At least 95 % new solder and no detachment or leaching of terminations.

Solderability is guaranteed at least for one year when stored in original package.

4 - ENVIRONMENTAL REQUIREMENTS

A list of the chemical substances content, which must not be used or whose use shall be limited by international law, is available on request.

Vishay confirms that the components specified in this specification do not contain asbestos nor cadmium, not even in the smallest volumes.

The manufacturer/supplier confirms that the component during normal handling, storage and assembly, as well as during operation in the automobile, is non toxic.



5 - INSPECTION CRITERIA

The supplier shall carry out visual examination with suitable equipment with approximately 10 x magnification and lighting appropriate to the specimen under test and the required quality level.

Chipping

The components shall be free of cracks or fissures. Small damages which do not deteriorate the performance of the component shall be less than 50 % of the surface of the MLCC as defined in EIA 595.

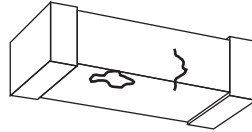

Delamination or Exposed Electrodes

No visible separation or delamination between layers of the capacitor and no exposed electrodes between the two terminals of the capacitor must be seen.

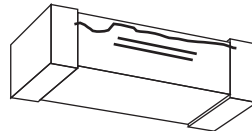

Metallization

For the metallization, no visible detachment of the metallized terminals and no exposed electrodes must be seen. Defects and gaps in the metallization on each sides of the terminal must not exceed 10 % of the total area (e.g. A, B, C, ...). Leaching shall not exceed 25 %.

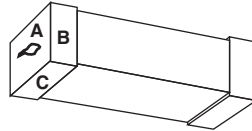

Electrode Distance

The ceramic body shall be free of any conducting material between the terminals which reduces the distance of the electrodes. The minimum distance 'd' is 400 μm for all package sizes, except 0603. For the component package '0603' the minimum distance is 200 μm .

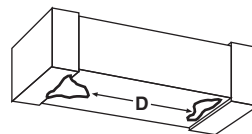

6 - BOARD FLEX TEST CONDITIONS
6.1 BOARD FLEX DEFINITIONS OF TEST

 PCB thickness = (1.6 ± 0.1) mm

 Copper thickness = 35 μ m

Material FR4 (EP-GC 02 according to DIN 40 802)

LAYOUT/PAD DESIGN (Dimensions in mm)			
TYPE	PAD SIZE		
	LL	LB	LEL
0603	2.20	1.00	0.75
0805	3.40	1.30	1.20
1206	4.50	1.80	1.20
1210	4.50	2.80	1.30
1812	4.75	3.60	1.50

Note

- LL = total length; LB = width of the pad; LEL = single pad length

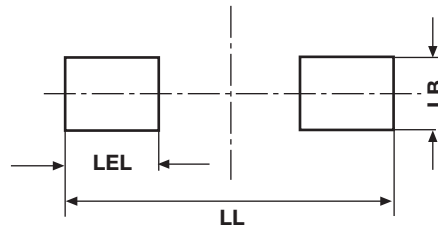

6.2 SOLDERING INSTRUCTIONS

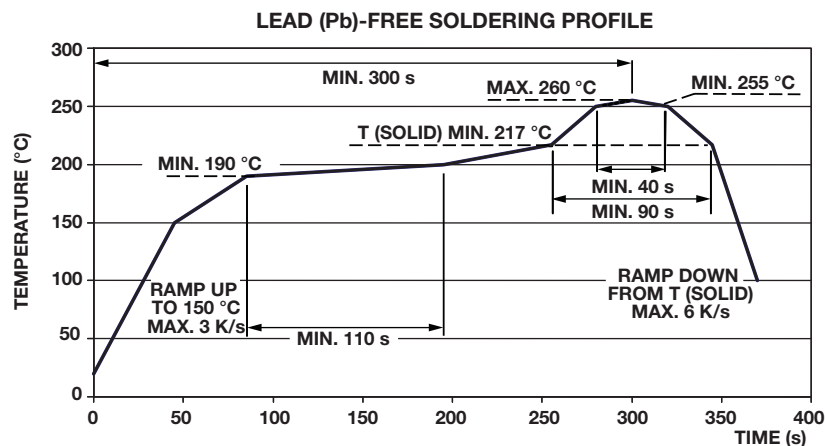
THICKNESS, RECOMMENDED FOR SOLDER PASTE (Reflow soldering)	
TYPE	THICKNESS in μ m
0402	75 to 90
0603	150 to 200
0805	150 to 200
1206	150 to 200
1210	150 to 200
1812	150 to 200

6.3 TYPICAL TEMPERATURE PROFILE FOR REFLOW SOLDERING (Boardflex test)

6.4 MOUNTING, DIMENSIONS AND TESTING

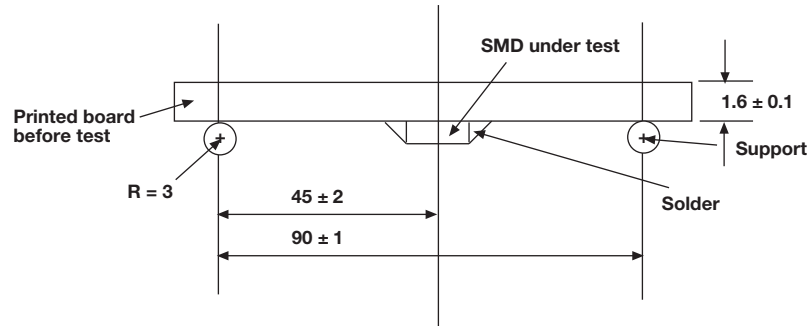
Mounting



Testing

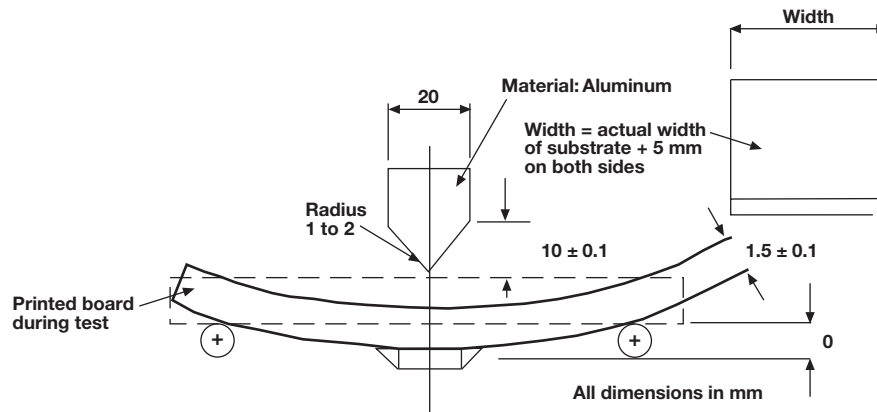

6.5 PERFORMANCE OF THE TEST(S)

- Electrical test according to component specification (Cap, DF, IR)
- Mounting to PCB
- Storage at room temperature (min. 10 h)
- Board flex test

6.6 DETAILS

X5R, X7R, X8R	PCB to be deflected continuously, speed 1 mm/s (± 0.5 mm/s)
C0G	PCB to be deflected in steps until cracks or other damages are visible or can be measured. Dwell time between steps: (5 ± 1) s

6.7 FAILURE CRITERIA

X5R, X7R, X8R	Piezoelectric sensor, no failure up to 2 mm
C0G	$\Delta C/C < 1\%$ or < 1 pF, no failure up to 3 mm
Both	Electrical test according to component specification



7 - AEC-Q200 QUALIFICATION TESTING

NO.	AEC-Q200 TEST ITEM	REFERENCE
1	Pre- and post stress electrical test	User spec
3	High temp exposure (storage)	MIL-STD-202, method 108
4	Temperature cycling	JESD22, method JA-104
5	Destructive physical analysis	EIA-469
6	Moisture resistance	MIL-STD-202, method 106
7	Biased humidity	MIL-STD-202, method 103
8	Operation life	MIL-STD-202 method 108
9	External Visual	MIL-STD-883 method 2009
10	Physical dimension	JESD22, method JB-100
13	Mechanical shock	MIL-STD-202, method 213
14	Vibration	MIL-STD-202, method 204
15	Resistance to solder heat	MIL-STD-202, method 215
16	ESD	AEC-Q200 rev. C
17	Solderability	J-STD-002
20	Electrical characterization	User spec
21	Board flex	AEC-Q200-005
22	Terminal strength	AEC-Q200-006
23	Beam load	AEC-Q200-003



Disclaimer

ALL PRODUCT, PRODUCT SPECIFICATIONS AND DATA ARE SUBJECT TO CHANGE WITHOUT NOTICE TO IMPROVE RELIABILITY, FUNCTION OR DESIGN OR OTHERWISE.

Vishay Intertechnology, Inc., its affiliates, agents, and employees, and all persons acting on its or their behalf (collectively, "Vishay"), disclaim any and all liability for any errors, inaccuracies or incompleteness contained in any datasheet or in any other disclosure relating to any product.

Vishay makes no warranty, representation or guarantee regarding the suitability of the products for any particular purpose or the continuing production of any product. To the maximum extent permitted by applicable law, Vishay disclaims (i) any and all liability arising out of the application or use of any product, (ii) any and all liability, including without limitation special, consequential or incidental damages, and (iii) any and all implied warranties, including warranties of fitness for particular purpose, non-infringement and merchantability.

Statements regarding the suitability of products for certain types of applications are based on Vishay's knowledge of typical requirements that are often placed on Vishay products in generic applications. Such statements are not binding statements about the suitability of products for a particular application. It is the customer's responsibility to validate that a particular product with the properties described in the product specification is suitable for use in a particular application. Parameters provided in datasheets and/or specifications may vary in different applications and performance may vary over time. All operating parameters, including typical parameters, must be validated for each customer application by the customer's technical experts. Product specifications do not expand or otherwise modify Vishay's terms and conditions of purchase, including but not limited to the warranty expressed therein.

Except as expressly indicated in writing, Vishay products are not designed for use in medical, life-saving, or life-sustaining applications or for any other application in which the failure of the Vishay product could result in personal injury or death. Customers using or selling Vishay products not expressly indicated for use in such applications do so at their own risk and agree to fully indemnify and hold Vishay and its distributors harmless from and against any and all claims, liabilities, expenses and damages arising or resulting in connection with such use or sale, including attorneys fees, even if such claim alleges that Vishay or its distributor was negligent regarding the design or manufacture of the part. Please contact authorized Vishay personnel to obtain written terms and conditions regarding products designed for such applications.

No license, express or implied, by estoppel or otherwise, to any intellectual property rights is granted by this document or by any conduct of Vishay. Product names and markings noted herein may be trademarks of their respective owners.