

# FS20UMA-5A

HIGH-SPEED SWITCHING USE

**FS20UMA-5A**

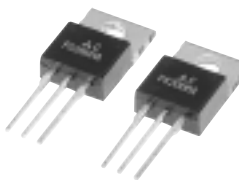

- 10V DRIVE
- V<sub>DSS</sub> ..... 250V
- r<sub>DS (ON)</sub> (MAX) ..... 0.20Ω
- I<sub>D</sub> ..... 20A

**OUTLINE DRAWING** Dimensions in mm

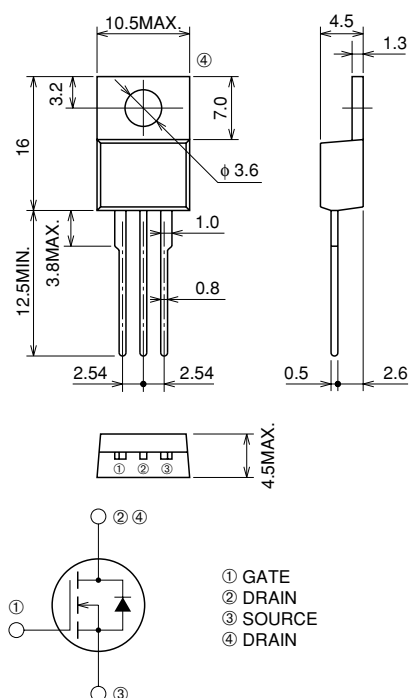

① GATE  
② DRAIN  
③ SOURCE  
④ DRAIN

**TO-220**

## APPLICATION

CRT Display monitor, SMPS, etc.

### MAXIMUM RATINGS (T<sub>c</sub> = 25°C)

Symbol	Parameter	Conditions	Ratings	Unit
V <sub>DSS</sub>	Drain-source voltage	V <sub>GS</sub> = 0V	250	V
V <sub>GSS</sub>	Gate-source voltage	V <sub>DS</sub> = 0V	±20	V
I <sub>D</sub>	Drain current		20	A
I <sub>DM</sub>	Drain current (Pulsed)		60	A
I <sub>DA</sub>	Avalanche current (Pulsed)	L = 200μH	20	A
P <sub>D</sub>	Maximum power dissipation		135	W
T <sub>ch</sub>	Channel temperature		-55 ~ +150	°C
T <sub>stg</sub>	Storage temperature		-55 ~ +150	°C
—	Weight	Typical value	2.0	g

**ELECTRICAL CHARACTERISTICS** (T<sub>ch</sub> = 25°C)

Symbol	Parameter	Test conditions	Limits			Unit
			Min.	Typ.	Max.	
V <sub>(BR)DSS</sub>	Drain-source breakdown voltage	I <sub>D</sub> = 1mA, V <sub>GS</sub> = 0V	250	—	—	V
I <sub>GSS</sub>	Gate-source leakage current	V <sub>GS</sub> = ±20V, V <sub>DS</sub> = 0V	—	—	±0.1	μA
I <sub>DSS</sub>	Drain-source leakage current	V <sub>DS</sub> = 250V, V <sub>GS</sub> = 0V	—	—	1	mA
V <sub>GS(th)</sub>	Gate-source threshold voltage	I <sub>D</sub> = 1mA, V <sub>DS</sub> = 10V	2.0	3.0	4.0	V
r <sub>DS(ON)</sub>	Drain-source on-state resistance	I <sub>D</sub> = 10A, V <sub>GS</sub> = 10V	—	0.15	0.20	Ω
V <sub>DS(ON)</sub>	Drain-source on-state voltage	I <sub>D</sub> = 10A, V <sub>GS</sub> = 10V	—	1.50	2.00	V
y <sub>fs</sub>	Forward transfer admittance	I <sub>D</sub> = 10A, V <sub>DS</sub> = 10V	—	20.0	—	S
C <sub>iss</sub>	Input capacitance	V <sub>DS</sub> = 25V, V <sub>GS</sub> = 0V, f = 1MHz	—	2250	—	pF
C <sub>oss</sub>	Output capacitance		—	220	—	pF
C <sub>rss</sub>	Reverse transfer capacitance		—	65	—	pF
t <sub>d(on)</sub>	Turn-on delay time	V <sub>DD</sub> = 150V, I <sub>D</sub> = 10A, V <sub>GS</sub> = 10V, R <sub>GEN</sub> = R <sub>GS</sub> = 50Ω	—	35	—	ns
t <sub>r</sub>	Rise time		—	60	—	ns
t <sub>d(off)</sub>	Turn-off delay time		—	400	—	ns
t <sub>f</sub>	Fall time		—	90	—	ns
V <sub>SD</sub>	Source-drain voltage	I <sub>S</sub> = 10A, V <sub>GS</sub> = 0V	—	1.5	2.0	V
R <sub>th(ch-c)</sub>	Thermal resistance	Channel to case	—	—	0.93	°C/W

**PERFORMANCE CURVES**

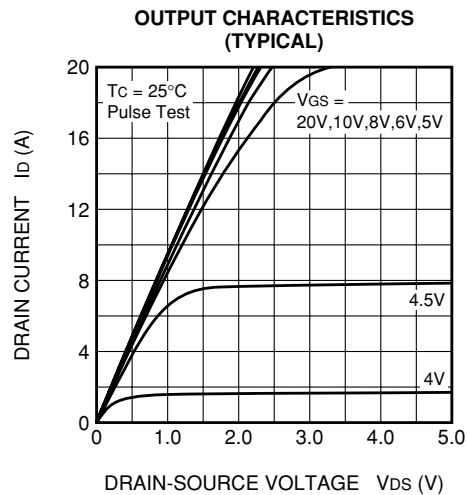
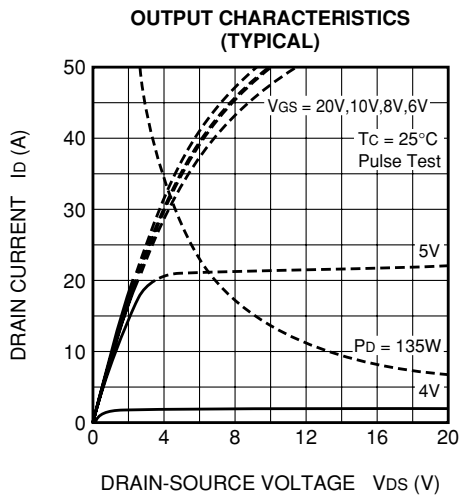
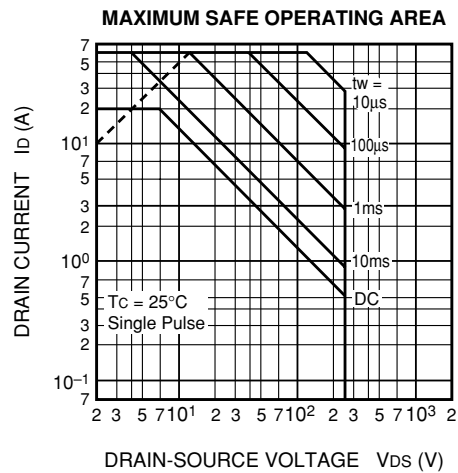
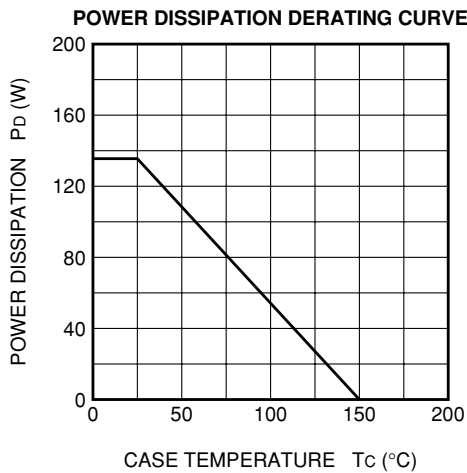

# FS20UMA-5A

HIGH-SPEED SWITCHING USE

**ON-STATE VOLTAGE VS. GATE-SOURCE VOLTAGE (TYPICAL)**

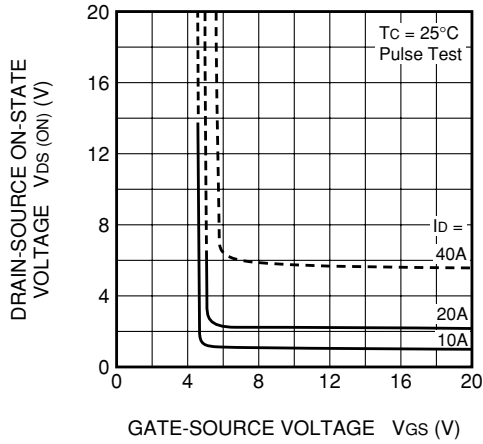

**ON-STATE RESISTANCE VS. DRAIN CURRENT (TYPICAL)**

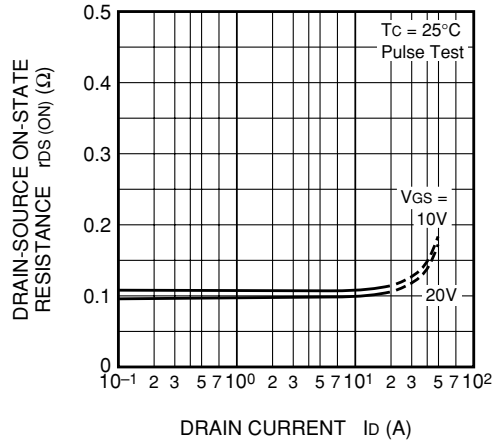

**TRANSFER CHARACTERISTICS (TYPICAL)**

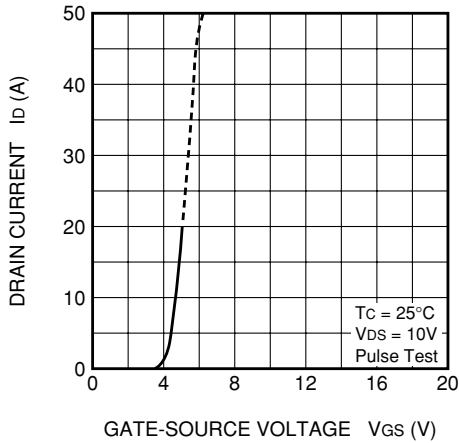

**FORWARD TRANSFER ADMITTANCE VS. DRAIN CURRENT (TYPICAL)**

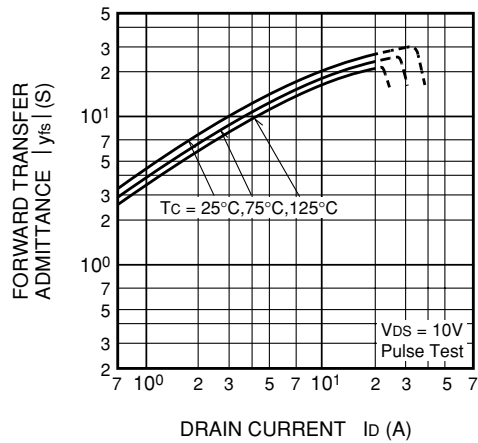

**CAPACITANCE VS. DRAIN-SOURCE VOLTAGE (TYPICAL)**

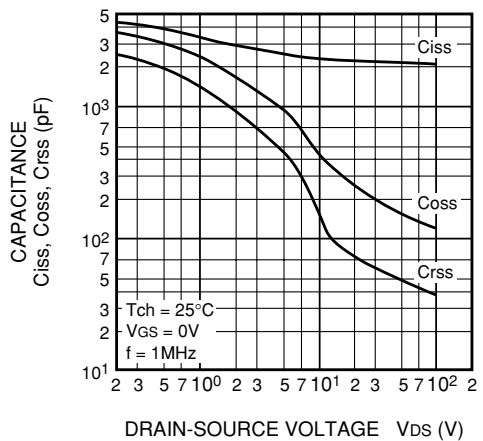

**SWITCHING CHARACTERISTICS (TYPICAL)**

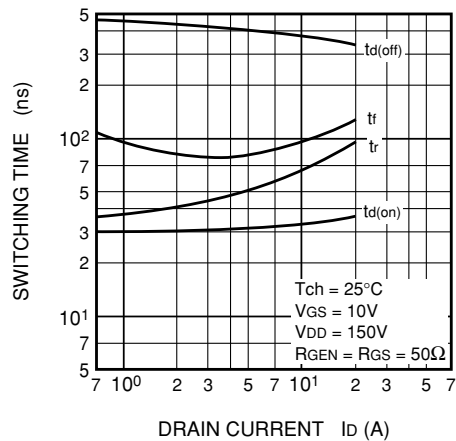

# FS20UMA-5A

HIGH-SPEED SWITCHING USE

**GATE-SOURCE VOLTAGE VS. GATE CHARGE (TYPICAL)**

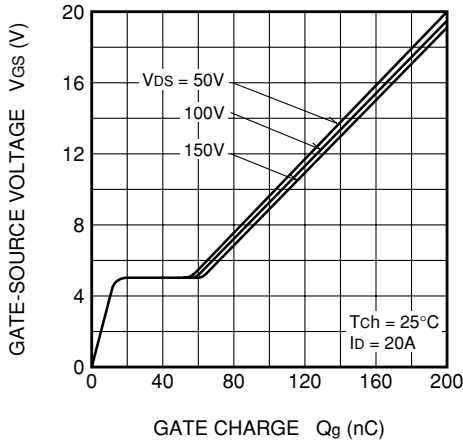

**SOURCE-DRAIN DIODE FORWARD CHARACTERISTICS (TYPICAL)**

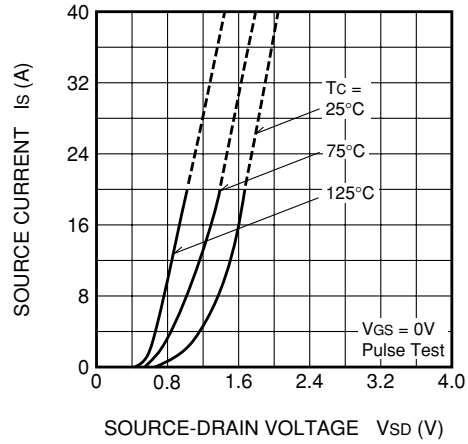

**ON-STATE RESISTANCE VS. CHANNEL TEMPERATURE (TYPICAL)**

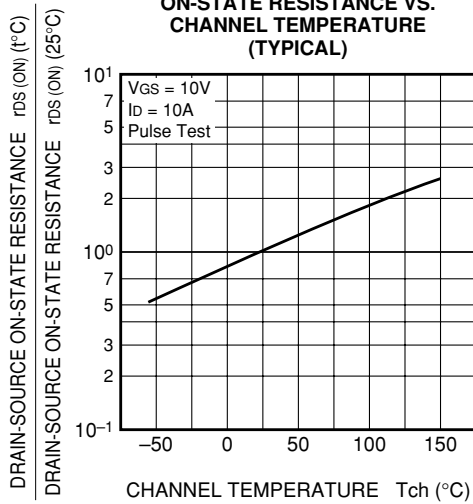

**THRESHOLD VOLTAGE VS. CHANNEL TEMPERATURE (TYPICAL)**

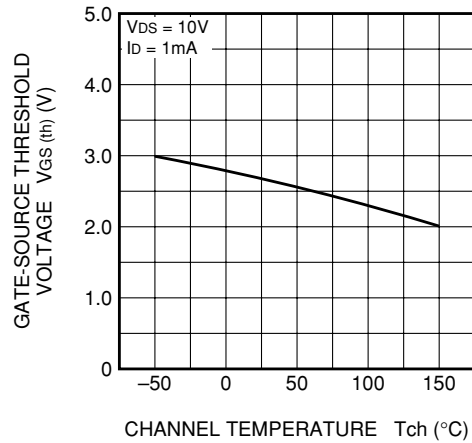

**BREAKDOWN VOLTAGE VS. CHANNEL TEMPERATURE (TYPICAL)**

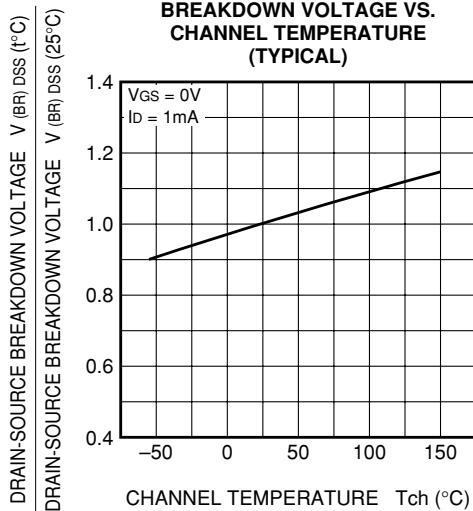

**TRANSIENT THERMAL IMPEDANCE CHARACTERISTICS**

