

OUTLINE OF SYSTEM

KIC9309AF-044 is a C-MOS LSI designed for FM/MW/LW radio of PLL frequency synthesizer system corresponded to the requirement of the whole world.
 Since prescaler and LCD driver are built in addition to PLL and controller, the compact 3 band digital tuning system of high performance home stereo can be constructed.

RECEIVING BAND

AREA	CODE	BAND	RECEIVING BAND (Hz)	STEP (Hz)	f _{ref} (Hz)	IF (Hz)
	A2A1A0					
EUROPE	000 or 010	FM	87.50 ~ 108.00 M	50 k	50 k	+ 10.70 M
		MW	522 ~ 1620 k	9 k	9 k	+ 459 k / + 450 k
		LW	144 ~ 288 k	1 k	1 k	
			153 ~ 279 k			
146 ~ 290 k						
USA 1	010	FM	87.5 ~ 108.1 M	200 k	50 k	+ 10.7 M
		MW	520 ~ 1720 k	10 k	10 k	+ 450 k
USA 2	011	FM	87.5 ~ 108.0 M	100 k	50 k	+ 10.7 M
		MW	520 ~ 1720 k	10 k	10 k	+ 450 k
LATIN AMERICA	100	FM	87.5 ~ 108.0 M	100 k	50 k	+ 10.7 M
		MW	520 ~ 1620 k	5 k	5 k	+ 450 k
AUSTRALIA/ MIDDLE AND NEAR EAST	101	FM	87.5 ~ 108.0 M	100 k	50 k	+ 10.7 M
		MW	531 ~ 1602 k	9 k	9 k	+ 450 k
JAPAN	110	FM	76.0 ~ 90.0 M	100 k	50 k	- 10.7 M
		MW	522 ~ 1629 k	9 k	9 k	+ 450 k
SOUTH AFRICA	111	FM	87.50 ~ 108.00 M	50 k	50 k	- 10.7 M
		MW	531 ~ 1620 k	9 k	9 k	+ 450 k

CODE="000" is 3 BAND version of Europe. CODE="001" is 2 BAND version of Europe.
 LW band is decided by LW0. LW1 jumper.

OUTLINE OF FUNCTION

- TUNING FUNCTION
 - MANUAL TUNING (UP/DOWN)
 - AUTO TUNING (SEEK)
 - PRESET MEMORY SCAN

- MEMORY FUNCTION

- FM : MAX 20 STATIONS
 - MW : 10 STATIONS
 - LW : 10 STATIONS
 - RANDOM MEMORY : MAX 40 STATIONS
 - each band have last memory.
-] FIXED MEMORY
MAX 40 STATIONS

- CLOCK FUNCTION

- 24 hour display in EUROPE
- 12 hour display in other area (with AM/PM indicator)
- timer on/off (once time timer/every day timer)
- sleep

- AUDIO CONTROL

- electric volume control (KIC9176/77P)
- function switch 6 inputs + tape monitor (KIC9164N)
- function indicator (KIC9174P)
- loudness control output and indicator (KIC9174P)
- -20dB muting function (KIC9174P)
- motor volume control output

- REMOTE CONTROL FUNCTION

- 32 key remote control decoder (transmitter KIC9243F)
- remote control direct output except tuner mode (KIC9173P)

- OTHER FUNCTION

- band change (1 key/3 key)
- stereo indicator
- monaural output and indicator
- clock display priority
- auto level down function.
- auto tuner function
- tracking data

KIC9309AF-044

KIC9309AF-044 LAY OUT

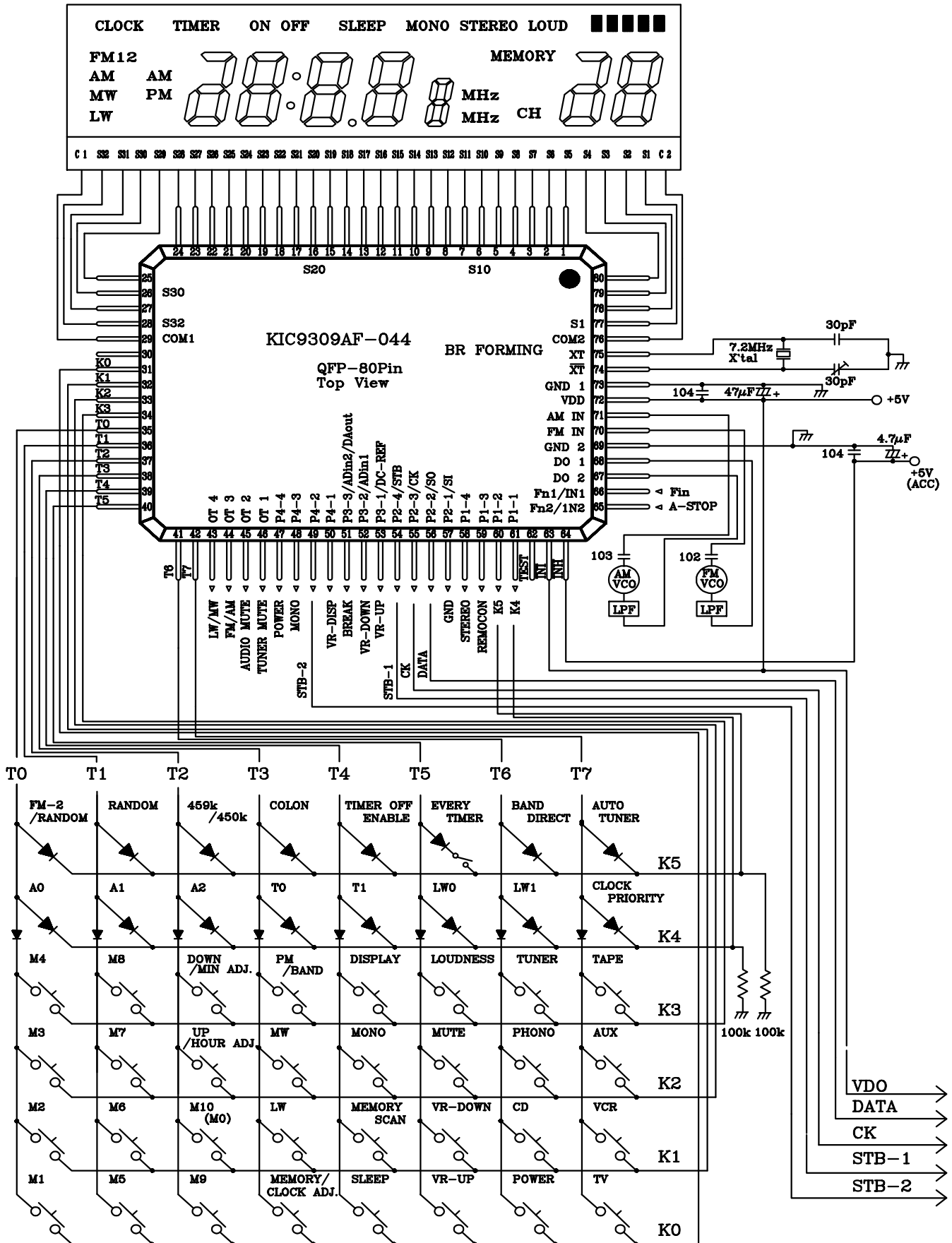

KIC9309AF-044

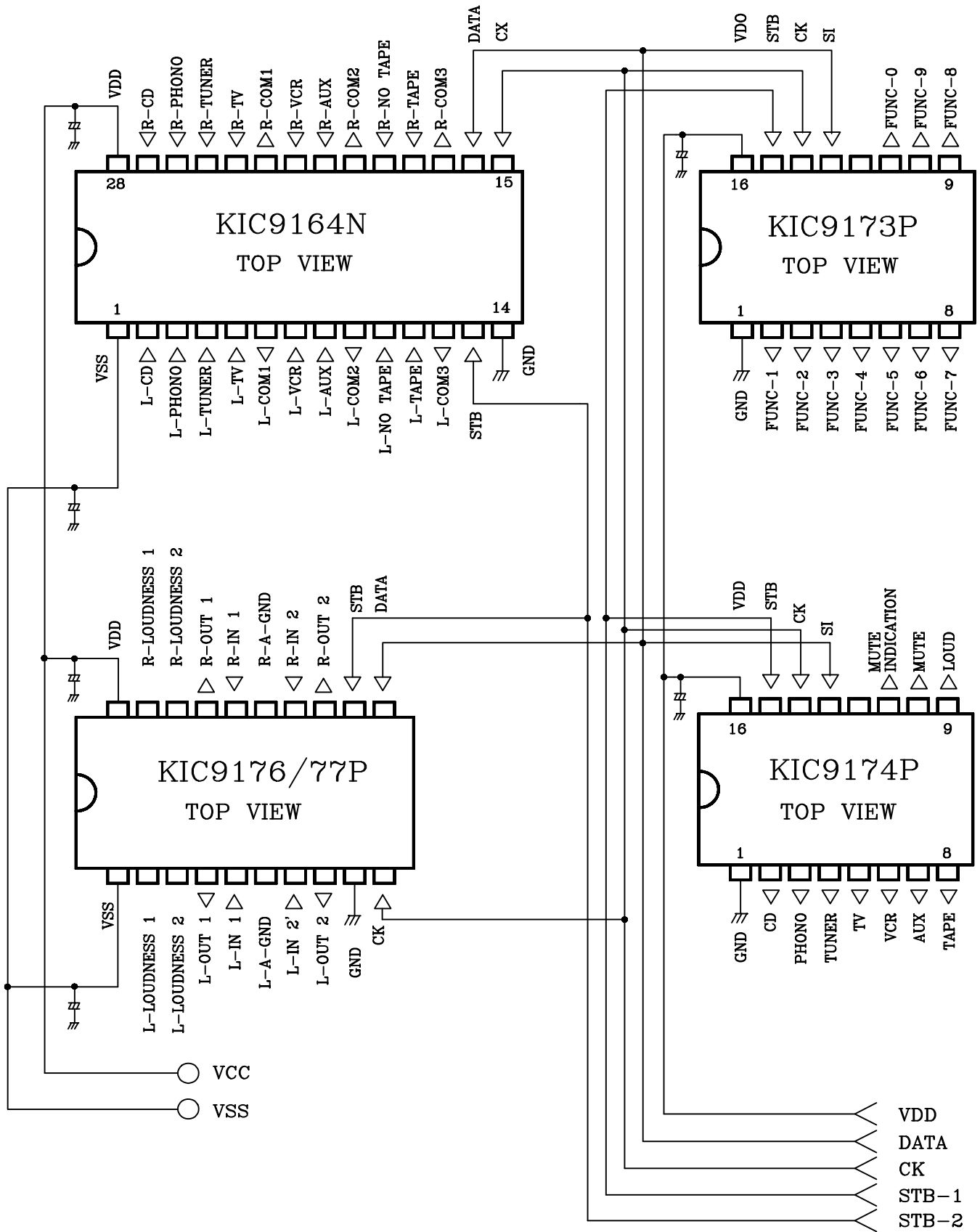

KIC9309AF-044

Key-map
LABEL

K0	K1	K2	K3		K4	K5
M1	M2	M3	M4	T0	* A0	* FM2- RANDOM ₄₀
M5	M6	M7	M8	T1	* A1	* RANDOM
M9	M10 (M0)	UP / MIN ADJ.	DOWN / HOUR ADJ.	T2	* A2	* 459k / 450k
MEMORY / CLOCK ADJ.	LW	MW	FM / BAND	T3	* T0	* COLON
SLEEP	MEMORY SCAN	MONO / STEREO	DISPLAY	T4	* T1	* TIMER OFF ENABLE
VR-UP	VR-DOWN	MUTE	LOUDNESS	T5	* LW0	** EVERY TIMER
POWER	CD	PHONO	TUNER	T6	* LW1	* BAND DIRECT
TV	VCR	AUX	TAPE	T7	* CLOCK PRIORITY	* AUTO TUNER

NOTE : 32 keys as shown above can be controlled by remote control.

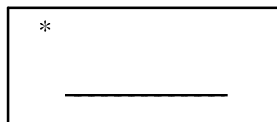

This is the diode jumper.

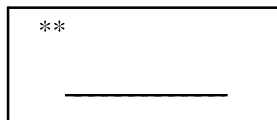

This is the diode switch.

KIC9309AF-044

FUNCTION

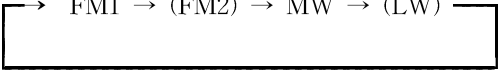
SYMBOL	EXPLANATION OF FUNCTION
M1 ~ M10 (M0)	Calling and writing preset memory. (ch 0 ~ ch 39)
UP (MINUTE -ADJUSTMENT) DOWN (HOUR -ADJUSTMENT)	In radio mode, the receiving frequency steps up or down by pushing (UP) or (DOWN) key. The auto tuning is started by pushing this key more than 500ms. During clock adjusting enable state, the minute of the clock is adjusted by the (UP) key. while the hour is adjusted by the (DOWN) key.
MEMORY (CLOCK -ADJUSTMENT)	When frequency is displayed, this key is use for setting of memory writing enable state. When clock is displayed, this key is used for setting of the clock adjusting enable state. The setting of timer is off when this key is pushed more than 1 sec. in the time of timer display.
FM / BAND MW LW	The receiving band is changed in radio display. The action is as shown below by the condition of BAND DIRECT jumper. The diode is set : Changing the receiving band directly by pushing (FM/BAND) key. (MW) key. (LW) key. The diode is no set : Changing the receiving band cyclically by every pushing (FM/BAND) key as shown below. 
SLEEP	The sleep function is set and adjust sleep time.
MEMORY SCAN	The preset memory is called in order, and will be received for 5 sec. if it is station. During memory scan, the display of channel number is flashing.
MONO	Changing STEREO/MONO in FM band of radio mode. The MONO OUTPUT is "H" and the "MONO" mark on LCD is indicated. When MONO is selected.

KIC9309AF-044

SYMBOL	EXPLANATION OF FUNCTION																																																															
DISPLAY	<p>Every pushing of this key, the display is changed as shown below.</p> <p>In case of clock and timer on/off enable</p> <div style="border: 1px solid black; padding: 5px; margin: 5px 0;"> <p style="text-align: center;">→ frequency → clock → timer on → timer off →</p> </div> <p>In case of clock and timer on enable.</p> <div style="border: 1px solid black; padding: 5px; margin: 5px 0;"> <p style="text-align: center;">→ frequency → clock → timer on →</p> </div> <p>In case of clock enable</p> <div style="border: 1px solid black; padding: 5px; margin: 5px 0;"> <p style="text-align: center;">→ frequency → clock →</p> </div> <p>In case of clock disable, this key is invalid.</p>																																																															
VR-UP VR-DOWN	Controlling the electronic volume or motor volume.																																																															
MUTE	<p>Used for ON/OFF of audio mute.</p> <p>When the mute on. "VOL" indicator is flashed and value of electronic volume is down 20 dB.</p> <p>At the muting, only (VR-UP) key is valid.</p>																																																															
LOUDNESS	<p>Used for changing ON/OFF of LOUDNESS.</p> <p>The "LOUD" mark on LCD is indicated. when the LOUDNESS function is on.</p>																																																															
POWER	Used for power ON/OFF.																																																															
CD PHONO TUNER TV VCR AUX	<p>Changing function.</p> <p>Switches of KIC9164N are shown below.</p> <table border="1" style="width: 100%; border-collapse: collapse; text-align: center;"> <thead> <tr> <th style="width: 20%;">FUNCTION</th> <th>S1</th> <th>S2</th> <th>S3</th> <th>S4</th> <th>S5</th> <th>S6</th> <th>S7</th> <th>S8</th> </tr> </thead> <tbody> <tr> <td>CD</td> <td>○</td> <td>×</td> <td>×</td> <td>×</td> <td>×</td> <td>×</td> <td>○</td> <td>×</td> </tr> <tr> <td>PHONO</td> <td>×</td> <td>○</td> <td>×</td> <td>×</td> <td>×</td> <td>×</td> <td>○</td> <td>×</td> </tr> <tr> <td>TUNER</td> <td>×</td> <td>×</td> <td>○</td> <td>×</td> <td>×</td> <td>×</td> <td>○</td> <td>×</td> </tr> <tr> <td>TV</td> <td>×</td> <td>×</td> <td>×</td> <td>○</td> <td>×</td> <td>×</td> <td>○</td> <td>×</td> </tr> <tr> <td>VCR</td> <td>×</td> <td>×</td> <td>×</td> <td>×</td> <td>○</td> <td>×</td> <td>○</td> <td>×</td> </tr> <tr> <td>AUX</td> <td>×</td> <td>×</td> <td>×</td> <td>×</td> <td>×</td> <td>○</td> <td>○</td> <td>×</td> </tr> </tbody> </table> <p>○ : ON, × : OFF</p>	FUNCTION	S1	S2	S3	S4	S5	S6	S7	S8	CD	○	×	×	×	×	×	○	×	PHONO	×	○	×	×	×	×	○	×	TUNER	×	×	○	×	×	×	○	×	TV	×	×	×	○	×	×	○	×	VCR	×	×	×	×	○	×	○	×	AUX	×	×	×	×	×	○	○	×
FUNCTION	S1	S2	S3	S4	S5	S6	S7	S8																																																								
CD	○	×	×	×	×	×	○	×																																																								
PHONO	×	○	×	×	×	×	○	×																																																								
TUNER	×	×	○	×	×	×	○	×																																																								
TV	×	×	×	○	×	×	○	×																																																								
VCR	×	×	×	×	○	×	○	×																																																								
AUX	×	×	×	×	×	○	○	×																																																								
TAPE	<p>Used for tape monitor ON/OFF,</p> <p>In case tape monitor is ON. S7 is OFF and S8 is ON of KIC9164N.</p>																																																															

KIC9309AF-044

SYMBOL	EXPLANATION OF FUNCTION				
* A 0 A 1 A 2	Setting the area of receiving station A2, A1, A0 = 000 : Europe(3bands) 001 : Europe(2bands) 010 : USA 1 011 : USA 2 100 : Latin America 101 : Australia, Middle and Near East 110 : Japan 111 : South Africa				
* T 0 T 1	Setting the clock and the timer.				
	T 0	T 1	clock	The display of clock during power is off.	timer
	0	0	×	×	×
	1	0	○	×	×
	0	1	○	○	×
	1	1	○	○	○
○ : There is function, × : There is no function.					
* LW 0 LW 1	Setting the receiving band of the LW band.				
	LW 1	LW 0	RECEIVING BAND		
	0	0	146 ~ 290 kHz		
	0	1	144 ~ 288 kHz		
	1	0	153 ~ 279 kHz		
	1	1	146 ~ 290 kHz		
1 : The diode set. 0 : The diode no set.					
* CLOCK PRIORITY	Setting the priority of the clock display in except the tuner mode. The diode set. : clock display The diode not set. : frequency display				
* FM 2 - RANDOM40	Setting the number of the memory The diode is set. : fixed memory : FM is 2 memory banks. (FM1/FM2) random memory : FM is only 1 memory bank. 40 memories The diode not set. : fixed memory : FM is only 1 memory banks. random memory : FM is only 1 memory bank. 30 memories				
* RANDOM	Setting the method of memory The diode set. : random memory The diode not set. : fixed memory				

* DIODE JUMPER

1996. 3. 22

Revision No : 1

KEC

8/40

KIC9309AF-044

SYMBOL	EXPLANATION OF FUNCTION
* 459 k / 450 k	Changing IF of AM band Only valid in the Europe area (A2/A1/A0="000" or "001") The diode set. : AM IF = 459 kHz The diode not set. : AM IF = 450 kHz
* COLON	Setting flashing colon of clock The diode set. : no flash The diode not set. : flash at 1 Hz rate
* TIMER OFF ENABLE	Setting the timer off. The diode set. : The timer on and the timer off is enable. The diode not set. : The timer on is only enable.
 EVERY TIMER	Setting the once/every timer The switch on. : every timer The switch off : once timer
* BAND DIRECT	Setting the way of changing band. The diode set. : The band is changed directly by pushing (FM/BAND) key. (MW) key, (LW) key. The diode not set : The band is changed cyclically by every pushing (FM/BAND) key.
* AUTO TUNER	Setting the function when power is on by timer. The diode set. : The function is set tuner when power is on by timer. The diode not set : The last function is set when power is on by timer.

* : DIODE JUMPER

KIC9309AF-044

I/O PORTS

PORT	NO.	NAME	I/O	FUNCTION	ACTIVE	INIT.
IN 1	66	IF-IN	IN	INTERMEDIATE FREQUENCY INPUT : The intermediate frequency (FM=10.7MHz, MW/LW=450kHz or 459kHz) is inputted through the condenser.	-	
IN 2	65	A-STOP		AUTO STOP SIGNAL INPUT : The signal of detected station is input from IF-IC to this pin.	H	
P1-1	61	K4		KEY SCAN RETURN INPUT : These are input ports for extending of key matrix.		
P1-2	60	K5				
P1-3	59	REMOCON		REMOCON INPUT : This terminal is for inputting the sio data of the remocon.	-	
P1-4	58	STEREO		INDICATING STEREO INPUT : "H" : "STEREO" is indicated "L" : "STEREO" is not indicated (When the MONO output is "H", "STEREO" will not be indicated) This is only valid in FM band.	H	
P2-1	57	GND		RESERVE INPUT connect the GND.	-	
P2-2	56	DATA		OPTION IC control OUTPUT : DATA : The serial data is outputted. CK : The serial clock is outputted. STB-1 : The strobe pulse is outputted. (for KIC9173/KIC9174P)		
P2-3	55	CK				
P2-4	54	STB-1				
P3-1	53	VR-UP	OUT	The motor volume control output : VR-UP/DOWN : The output port that correspond to pushing volume up/down key is "H" BREAK : This port is outputted "H" for 50mS when volume key is released. VOL-DISP : This output is flashed when volume key is pushed.	H	L
P3-2	52	VR-DOWN				
P3-3	51	BREAK				
P4-1	50	VOL-DISP			-	L
P4-2	49	STB2	OPTION IC CONTROL OUTPUT : The strobe pulse is outputted. (for KIC9164N / KIC9176, KIC9177P)	-	L	

KIC9309AF-044

PORT	NO.	NAME	I/O	FUNCTION	ACTIVE	INIT.		
P4-3	48	MONO	OUT	MONO/STEREO OUTPUT : When the mono is selected, this pin is set to "H" and all stations are treated as monaural.	H	L		
P4-4	47	POWER		POWER ON/OFF CONTROL OUTPUT POWER ON : "H" POWER OFF : "L"				
OT-1	46	TUNER MUTE		The mute output for tuner.				
OT-2	45	AUDIO MUTE		The mute output for audio.				
OT-3	44	FM/AM		BAND OUTPUT	-	H		
		PORT					FM	MW
		FM/AM				"H"	"L"	"L"
OT-4	43	LW/MW		LW/MW		"L"	"L"	
				"H"	L			

KIC9309AF-044

KIC9174P Extending output ports

PORT	NO.	NAME	I/O	FUNCTION	ACTIVE	INIT.																																																	
OP-1	2	CD	OUT	The output for the display of function : The output that correspond to the function is outputted. ○ : L × : HZ	L	HZ																																																	
OP-2	3	PHONO			L	HZ																																																	
OP-3	4	TUNER		<table border="1" style="width: 100%; border-collapse: collapse; text-align: center;"> <thead> <tr> <th style="width: 15%;">FUNCTION</th> <th>S1</th> <th>S2</th> <th>S3</th> <th>S4</th> <th>S5</th> <th>S6</th> </tr> </thead> <tbody> <tr> <td>CD</td> <td>○</td> <td>×</td> <td>×</td> <td>×</td> <td>×</td> <td>×</td> </tr> <tr> <td>PHONO</td> <td>×</td> <td>○</td> <td>×</td> <td>×</td> <td>×</td> <td>×</td> </tr> <tr> <td>TUNER</td> <td>×</td> <td>×</td> <td>○</td> <td>×</td> <td>×</td> <td>×</td> </tr> <tr> <td>TV</td> <td>×</td> <td>×</td> <td>×</td> <td>○</td> <td>×</td> <td>×</td> </tr> <tr> <td>VCR</td> <td>×</td> <td>×</td> <td>×</td> <td>×</td> <td>○</td> <td>×</td> </tr> <tr> <td>AUX</td> <td>×</td> <td>×</td> <td>×</td> <td>×</td> <td>×</td> <td>○</td> </tr> </tbody> </table>	FUNCTION	S1	S2	S3	S4	S5	S6	CD	○	×	×	×	×	×	PHONO	×	○	×	×	×	×	TUNER	×	×	○	×	×	×	TV	×	×	×	○	×	×	VCR	×	×	×	×	○	×	AUX	×	×	×	×	×	○	L	L
FUNCTION	S1	S2		S3	S4	S5	S6																																																
CD	○	×		×	×	×	×																																																
PHONO	×	○		×	×	×	×																																																
TUNER	×	×		○	×	×	×																																																
TV	×	×		×	○	×	×																																																
VCR	×	×	×	×	○	×																																																	
AUX	×	×	×	×	×	○																																																	
OP-4	5	TV	L	HZ																																																			
OP-5	6	VCR	L	HZ																																																			
OP-6	7	AUX	L	HZ																																																			
OP-7	8	TAPE	OUT	The output for the display of tape monitor.	L	HZ																																																	
OP-8	9	LOUDNESS	OUT	The output for control of loudness	L	HZ																																																	
OP-9	10	MUTE	OUT	The output for the control of the "-20dB" muting	L	HZ																																																	
OP-10	11	MUTE INDICA- TION	OUT	The output for the display of the "-20dB" muting When mute is on, flashing at 1 Hz rate.	-	HZ																																																	

HZ : HIGH IMPEDANCE.

KIC9309AF-044

KIC9173P Extending output ports

PORT	NO.	NAME	I/O	FUNCTION	ACTIVE	INIT.
I/O-1	2	FUNC-1	OUT	The output for the function of remocon. The output that correspond to the keys is outputted. when the (M1/FUNC1)~(M0/FUNC0) key on the transmitter was pushed in except the tuner mode.	L	HZ
I/O-2	3	FUNC-2			L	HZ
I/O-3	4	FUNC-3			L	HZ
I/O-4	5	FUNC-4			L	HZ
I/O-5	6	FUNC-5			L	HZ
I/O-6	7	FUNC-6			L	HZ
I/O-7	8	FUNC-7			L	HZ
I/O-8	9	FUNC-8			L	HZ
I/O-9	10	FUNC-9			L	HZ
I/O-10	11	FUNC-0			L	HZ

HZ : HIGH IMPEDANCE

KIC9309AF-044

LCD map

SYMBOL	PIN NO.	SEGMENT NAME		FUNCTION
		COM 1	COM 2	
COM 1	29	COM 1	-	COMMON 1
S 32 S 31 S 30 S 29	28 27 26 25	CLOCK FM AM MW	TIMER 1 2 AM	CLOCK : CLOCK MODE TIMER : TIMER MODE FM : FM BAND MW : MW BAND (In case of there is no LW band.)
S 28 S 27 S 26 S 25	24 23 22 21	LW ON 1b 2f	PM ladeg 1c 2b	AM : MW BAND (In case of there is LW band.) LW : LW BAND ON : ON TIME of TIMER MODE
S 24 S 23 S 22 S 21	20 19 18 17	2e 2d : SLEEP	2g 2c 2a OFF	1, 2 : MEMORY BANK (FM1/2) AM : AM/PM of clock PM : AM/PM of clock SLEEP : SLEEP ON ":": COLON of CLOCK
S 20 S 19 S 18 S 17	16 15 14 13	3f 3e 3d MONO	3b 3g 3c 3a	1g-a : 23:55/108.05 2g-a : 23:55/108.05 OFF : OFF TIME of TIMER MODE. 3g-a : 23:55/108.05 MONO : MONAURAL
S 16 S 15 S 14 S 13	12 11 10 9	4f 4e 4d 5be	4b 4g 4c 4a	4g-a : 23:55/108.05 5g-a : 108.05 MEMORY : MEMORY STORE STATE MHz, ".": MHz, FM dot kHz : kHz CH : CHANNEL
S 12 S 11 S 10 S 9	8 7 6 5	5acdf MEMORY kHz STEREO	5g MHz, ".": CH LOUD	STEREO : STEREO STATION LOUD : LOUDNESS 6g-a : CH 10 7g-a : CH 10 V1~V5 : VOLUME S-METER LEVEL
S 8 S 7 S 6 S 5	4 3 2 1	6e 6b 7f 7e	6adg 6c 7b 7g	
S 4 S 3 S 2 S 1	80 79 78 77	7d V5 V3 V1	7c 7a V4 V2	
COM 2	76	-	COM 2	COMMON 2

LCD ARRANGEMENT FIGURE *

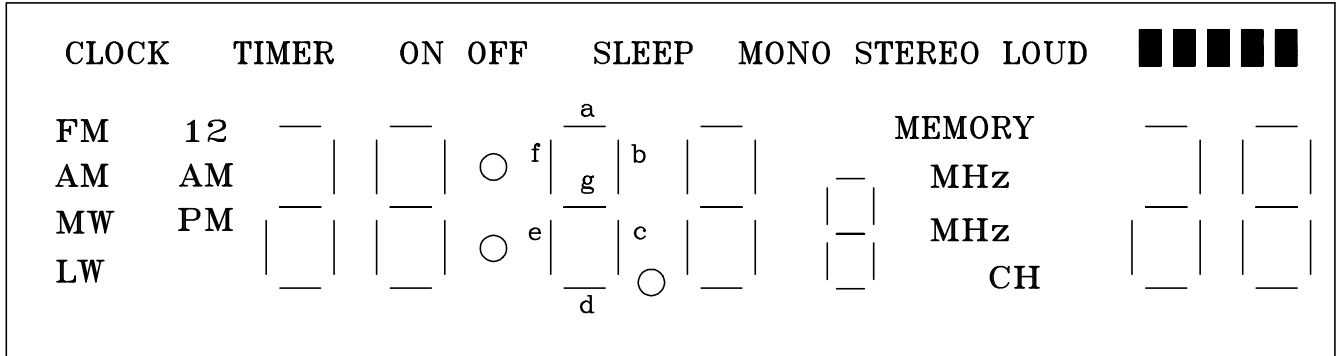

THE EXPLANATION OF FUNCTIONS

FUNCTION	PAGE
1. BAND CHANGE	17
2. TUNING	18
3. AUTO STOP AND IF COUNTER	19
4. PRESET MEMORY	20
5. MEMORY SCAN	22
6. REMOTE CONTROL	23
7. FUNCTION CHANGE	25
8. VOLUME CONTROL	26
9. VOLUME MUTE	27
10. CLOCK	28
11. TIMER	30
12. SLEEP	33
13. INITIALIZE	34
14. THE EXPLANATION OF DISTURBANCE WHILE FUNCTIONS ARE EXECUTING	35
15. TIMING	37

BAND CHANGE

1. PRINCIPAL FUNCTION

changing the receiving band

2. KEY AND I/O PORT TO BE USED

(FM/BAND) key, (MW) key, (LW) key, FM2-RANDOM40 jumper, FM/AM OUTPUT, LW/MW OUTPUT BAND DIRECT jumper, TUNER-MUTE OUTPUT.

3. FUNCTIONS

- a. In case the BAND DIRECT jumper is no set, every pushing the (FM/BAND) key is changed the receiving band cyclically.
- b. In case the BAND DIRECT jumper is set, the receiving band is changed directly by pushing (FM/BAND) key or (MW) key or (LW) key.
- c. In case the BAND DIRECT jumper is set, the order of changing the band is as shown below.

- In case of A0, A1, A2 = 0,0,0

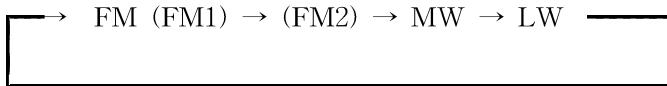

- other case

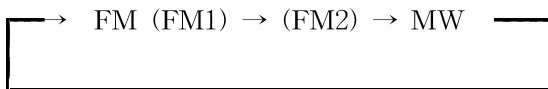

- d. The FM band has 2 memory banks in case that the FM2-RANDOM40 jumper is set. (FM1/FM2) But, the FM band has only 1 memory bank when the random jumper is set.
- e. In case the FM band has 2 memory banks and the BAND DIRECT jumper is set, the band is changed to FM1 always when the (FM/BAND) key was pushed on the band except FM.
- f. In case the FM band has 2 memory banks and the BAND DIRECT jumper is set. When the (FM/BAND) key was pushed on the FM band, the band is changed cyclically between FM1 and FM2.
- g. The FM/AM OUTPUT and the LW/MW OUTPUT are as shown below.

PORT	FM	MW(AM)	LW
FM/AM	H	L	L
LW/MW	L	L	H

- h. The "FM" mark and the "MHz" mark are on when the receiving band is FM.
 In case there are 2 memory banks, the "1" mark or "2" mark is on.
 The "MW" mark or the "AM" mark, and the "kHz" mark are on when the receiving band is MW.
 The "LW" mark and the "kHz" mark are on when the receiving band is LW.
- i. The TUNER-MUTE OUTPUT is "H" for 1 sec. When the receiving band is changed.

TUNING

1. PRINCIPAL FUNCTION

The 1 step / 1 push and auto tuning by pushing the (UP/MIN-ADJ.) or (DOWN/HOUR-ADJ.) key.

2. KEY AND I/O PORT TO BE USED

(UP/MIN-ADJ.) key. (DOWN/HOUR-ADJ.) key. IF-IN INPUT, A-STOP INPUT

3. FUNCTIONS

- a. The 1 step / 1 push tuning is executed by pushing the (UP/MIN-ADJ.) or (DOWN/HOUR-ADJ.) key for less than 500mS.
- b. When the (UP/MIN-ADJ.) key or (DOWN/HOUR-ADJ.) key is pushed for more than 500mS. the auto tuning is started.
- c. The auto tuning is stopped, if the stop signal is detected on the A-STOP INPUT or the intermediate frequency is counted by the IF counter.
- d. When the (UP/MIN-ADJ.) key or the (DOWN/HOUR-ADJ.) key is pushed continuous, the auto tuning is not stopped when the above mentioned signal is inputted on the IF-IN INPUT or the A-STOP INPUT.
- e. The tuning method is the saw tooth wave form method, and when the receiving frequency reached the band edge, it goes to the opposite side and the auto tuning is held for 500mS.
- f. The speed of the auto tuning is 50mS/step.

KIC9309AF-044

AUTO STOP and IF COUNTER

1. PRINCIPAL FUNCTION

Detecting A-STOP signal or Counting IF

2. I/O TO BE USED

IF-IN INPUT, A-STOP INPUT

3. FUNCTIONS

- a. The intermediate frequency (IF) is counted and the auto stop signal is detected. as condition of stopping for the auto tuning and the memory scan.
- b. It is judged to be station when the stop signal is detected in the method as shown below on the A-STOP INPUT or the IF-IN INPUT.
- c. The IF frequency is inputted on the IF-IN INPUT, and counted.
If the IF counted is in wide range, after 100mS the IF is counted on same receiving frequency again.
If the IF counted is narrow range, it is judged to be the station.

In case of IF check

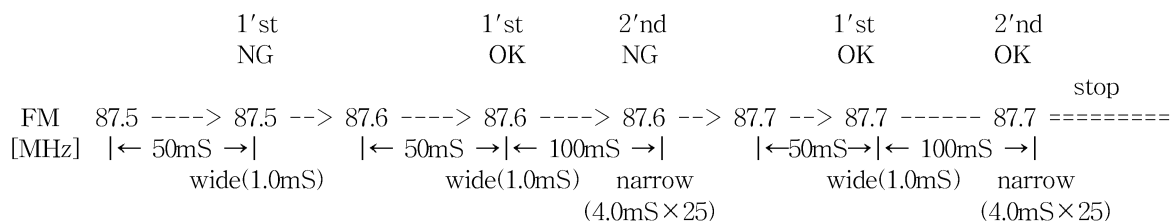

- d. The auto stop signal is inputted on the A-STOP INPUT.
If the A-STOP INPUT is "H", after 100mS the auto stop signal is detected on same receiving frequency again. If the A-STOP INPUT is "H" again, it is judged to be station.

In case of auto stop check

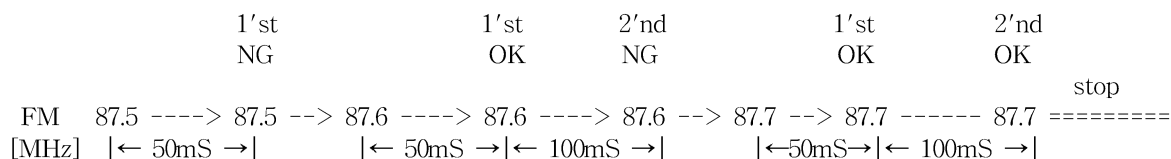

e. Setting value of IF check

BAND	REFERENCE FREQUENCY (Hz)	First counting (WIDE)		Second counting (NARROW)	
		DETECTED WIDTH (Hz)	GATE TIME (mS)	DETECTED WIDTH (Hz)	GATE TIME (mS)
MW	9 k	450k ± 12.0k	4.0	450k ± 3.0k	16.0
	10 k	(459k ± 12.0k)		(459k ± 3.0k)	
FM	50 k	10.7M ± 80k	1.0	10.7M ± 15k	4.0 × 25 times
LW	1 k	450k ± 2.4k (459k ± 2.4k)	4.0	450k ± 0.6k (459k ± 0.6k)	16.0

() : In case the jumper of the 459k/450k is set.

PRESET MEMORY

1. PRINCIPAL FUNCTION

Calling and writing in the preset memory

2. KEY TO BE USED

(M1)~(M10(M0)) key, (MEMORY/CLOCK-ADJUSTMENT) key, RANDOM jumper, FM2-RANDOM 40 jumper
TUNER-MUTE OUTPUT

3. FUNCTIONS

- a. In case the RANDOM jumper is not set, there are each 10 stations for FM1, FM2, MW and LW band.
In case the RANDOM jumper is set, there are 30 or 40 stations.
- b. The preset memory method is set by the random jumper.
In case the random jumper is set, it is in the random memory method.
In case the random jumper is not set, it is in the fixed memory method.
- c. In case the FM2-RANDOM40 jumper is set in the fixed memory method, there are two memory banks of FM band.
In case the FM2-RANDOM40 jumper is not set, there is only 1 memory bank.
- d. One memory bank have 10 memories in the fixed memory method.
- e. In case the FM2-RANDOM40 jumper is set in the random memory method, the number of of memories is 40.
In case the FM2-RANDOM40 jumper is not set, the number of the memories is 30.
- f. There is ch 0 in case the number of preset memories is 40. (0ch~39ch)
- g. In case of calling the preset memory-fixed memory method
 - ① The receiving frequency written in the memory is called by the pushing the (M1)~(M10(M0)) key.
 - ② The memory of the key pushed can be called immediately when the (M1)~(M10(M0)) key is pushed.
- h. In case of calling the preset memory-random memory method
 - ① The receiving frequency written in the memory is called immediately when the (M4)~(M9) key is pushed.
 - ② But, in case (M10(M0))~(M3) key is pushed. the ch number is only flashed for 2 seconds. And after 2 sec, the preset memory of key pushed is called.
 - ③ The ch10~ch39 can be called by pushing (M1)~(M10(M0)) key during ch number is flashed. In this case, the ch number was flashed, is 10 digit. The ch number of key pushed is 1 digit.
- i. When the preset memory is called, the TUNER-MUTE OUTPUT is output "H" for 500ms.
If the band of the preset memory called is different from current band. the TUNER-MUTE OUTPUT is output "H" for 1000mS.
However the TUNER-MUTE OUTPUT is not output "H" if the memory number of the key pushed and the memory number that is receiving now is same.

j. In case of writing in preset memory

- ① If the (MEMORY/CLOCK-ADJUSTMENT) key is pushed in the radio mode, it is the memory writing enable state for 5 sec.
- ② The "MEMORY" mark is on in the memory writing enable state.
- ③ If the (M1)~(M10(M0)) key is pushed in the memory writing enable state, the receiving frequency is written in the memory of the key pushed in the fixed memory method.
- ④ In case of random memory method during memory writing enable state., the way of setting ch number is same as calling the preset memory.
- ⑤ If the receiving frequency is written in the preset memory, the "MEMORY" mark is off and the memory number of the key pushed is indicated on LCD.

k. If the (MEMORY/CLOCK-ADJUSTMENT) key is pushed in the memory writing enable state, the state is released.

l. After 5 sec from setting of memory writing enable state, the state is released.

MEMORY SCAN

1. PRINCIPAL FUNCTION

Calling the preset memory in order.

2. KEY TO BE USED

(MEMORY SCAN) key, IF-IN INPUT, A-STOP INPUT, TUNER-MUTE OUTPUT

3. FUNCTIONS

a. When the (MEMORY SCAN) key is pushed, the memory scan function is started from next memory number of receiving memory number.

If the preset memory have not been called, the memory scan function is started from ch1.

During the memory scan, the frequency written in the memory is received for 5 sec in order.

b. During the memory scan, the channel number flashed at 1 Hz.

c. The TUNER-MUTE OUTPUT is outputted for 500mS when the preset memory is called.

If the receiving band that is received now and the band called is different, the TUNER-MUTE OUTPUT is outputted for 1000mS.

d. In case of the fixed memory, the band is changed as shown below and the memory scan is continuous from ch 1, after receiving the all memories of current memory bank.

In case of FM BAND (FM 2 band)

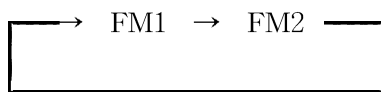

In case of FM 1 band, MW band, LW band, the band is not changed.

e. If the station is not received (by check the IF or A-STOP signal) when the preset memory is called, the next preset memory is called immediately.

If the station is received, the next preset memory is called after receiving the station for 5 sec.

f. When the (MEMORY SCAN) key is pushed during the memory scan, the memory scan is stopped on the preset memory that is receiving now.

REMOTE CONTROL

1. Principal function

Receiving the remote control data from the KIC9243F.

2. I/O TO BE USED

REMOCON INPUT

3. FUNCTIONS

- a. The transmitter IC is KIC9243F.
- b. The custom code for the remote control is "90".
- c. The key action that correspond to the remote control data is executed.
- d. The all radio related key is valid in the tuner mode.
However, the radio related key is invalid in the mode excepting the tuner mode.
- e. But, the (M1/FUNC1)~(M10(M0)/FUNC0) key is valid for func out (KIC9173P) except tuner mode.
The output port of the pushed key on the KIC9173P is "L" during the key on transmitter was pushed.
- f. The valid key on transmitter in case power is off, is the (POWER) key and the (SLEEP) key.
But, in case the power is off when timer is set, it is the (DISPLAY) key.

KIC9309AF-044

g. The setting for the remote control data on the KIC9309AF-044 is as shown below.

DATA	D0	D1	D2	D3	D4	D5	D6	D7	DTS KEY
K 01	1	0	0	0	0	0	0	0	M1 / FUNC 1
K 02	0	1	0	0	0				M5 / FUNC 5
K 03	1	1	0	0	0				MEMORY / CLOCK ADJ.
K 04	0	0	1	0	0				SLEEP
K 05	1	0	1	0	0				M9 / FUNC 9
K 06	0	1	1	0	0				POWER
K 07	1	1	1	0	0				TV
K 08	0	0	0	0	0	1	0	0	VR-UP
K 09	1	0	0	1	0	0	0	0	M2 / FUNC 2
K 10	0	1	0	1	0				M6 / FUNC 6
K 11	1	1	0	1	0				LW
K 12	0	0	1	1	0				MEMORY SCAN
K 13	1	0	1	1	0				M10 (M0) / FUNC0
K 14	0	1	1	1	0				CD
K 15	1	1	1	1	0				VCR
K 16	0	0	0	0	0	1	1	0	VR-DOWN
K 17	1	0	0	0	1	0	0	0	M3 / FUNC 3
K 18	0	1	0	0	1				M7 / FUNC 7
K 19	1	1	0	0	1				MW
K 20	0	0	1	0	1				MONO / STEREO
K 21	1	0	1	0	1				MUTE
K 22	0	1	1	0	1				PHONO
K 23	1	1	1	0	1				AUX
K 24	0	0	0	0	0	1	0	1	UP / MIN ADJ.
K 25	1	0	0	1	1	0	0	0	M4 / FUNC 4
K 26	0	1	0	1	1				M8 / FUNC 8
K 27	1	1	0	1	1				BAND / FM
K 28	0	0	1	1	1				DISPLAY
K 29	1	0	1	1	1				LOUDNESS
K 30	0	1	1	1	1				TUNER
K 31	1	1	1	1	1				TAPE
K 32	0	0	0	0	0	1	1	1	DOWN / HOUR ADJ.

KIC9309AF-044

FUNCTION CHANGE

1. PRINCIPAL FUNCTION

Changing the source of the amplifier.

2. KEY AND I/O TO BE USED

(CD) key, (PHONO) key, (TUNER) key, (TV) key, (VCR) key, (TAPE) key
DATA OUTPUT, CK OUTPUT, STB-1 OUTPUT, AUDIO-MUTE OUTPUT.

3. FUNCTIONS

- a. The source that is inputted to the amplifier is selected by pushing the aforesaid keys.
- b. The selecting of the source is controlled by the KIC9164N, and the display of the selected source is outputted on the KIC9174P.
They are controlled by sending the serial data from the KIC9309F.
- c. The KIC9164N and the KIC9174P is set condition as shown below according to the source.

Internal switch of the KIC9164N (○:ON, ×:OFF)

SOURCE	SW1	SW2	SW3	SW4	SW5	SW6	SW7	SW8
C D	○	×	×	×	×	×	○	×
PHONO	×	○	×	×	×	×	○	×
TUNER	×	×	○	×	×	×	○	×
T V	×	×	×	○	×	×	○	×
V C R	×	×	×	×	○	×	○	×
A U X	×	×	×	×	×	○	○	×
TAPE	-	-	-	-	-	-	×	○

OUTPUT of the KIC9174P

SOURCE	IO1	IO2	IO3	IO4	IO5	IO6	IO7
C D	L	H	H	H	H	H	H
PHONO	H	L	H	H	H	H	H
TUNER	H	H	L	H	H	H	H
T V	H	H	H	L	H	H	H
V C R	H	H	H	H	L	H	H
A U X	H	H	H	H	H	L	H
TAPE	-	-	-	-	-	-	L

- : DON'T CARE

- d. The tape source and other source is changed cyclical, if the (TAPE) key is pushed.
- e. If source key except the (TAPE) key is pushed when the tape source is selected, the source of the key pushed is selected and the tape source is automatically off.
- f. The AUDIO-MUTE OUTPUT is outputted for 1000mS when the source was changed.

KIC9309AF-044

VOLUME CONTROL

1. PRINCIPAL FUNCTION

Controlling the electric volume and motor volume

2. KEY AND I/O PORT TO BE USED

(VR-UP) key, (VR-DOWN) key, (LOUDNESS) key, DATA OUTPUT, CK OUTPUT, STB-2 OUTPUT
LOUD OUTPUT, VR-UP OUTPUT, VR-DOWN OUTPUT, VR-DISP OUTPUT, BREAK OUTPUT.

3. FUNCTIONS

- a. The level of electric volume (KIC9176/77P) that can be used is from 0 dB to -76 dB and $-\infty$ dB.
- b. The 2dB step/1 push up/down is executed by pushing the (VR-UP) key or (VR-DOWN) key for less than 500mS.
- c. When the (VR-UP) key or (VR-DOWN) key is pushed for more than 500mS. the continuous up/down (2 dB/50mS) is started. If that key is released, it is stopped.
- d. The KIC9309F send the serial data to the KIC9176/77P when the volume level is changed.
- e. The VR-UP OUTPUT is 'H' during the (VR-UP) key is pushed.
The VR-DOWN OUTPUT is "H" during the (VR-DOWN) key is pushed.
- f. The VR-DISP OUTPUT is flashing at 100Hz rate during. The (VR-UP) key or the (VR-DOWN) key is pushed.
- g. The VR-BREAK OUTPUT is outputted for 50mS when [VR-UP] key or [VR-DOWN] key is released.
- h. The volume level is displayed on the LCD.
The V1~V5 mark on the LCD that correspond to the volume level is displayed as shown below.

VOLUME LEVEL	$-\infty$ dB	-76~-70dB	-68~-60dB	-58~-50dB	-48~-40dB
LCD	V1		V1, V2		V1~V3

VOLUME LEVEL	-38~-30dB	-28~-20dB	-18~-10dB	-8~-2dB	0dB
LCD	V1~V3	V1~V4		V1~V5	

- i. The loudness function is set ON/OFF cyclically by pushing the (LOUDNESS) key.
- j. When the loudness function is on. the "LOUD" mark on the LCD is indicated and the LOUD OUTPUT on the KIC9174P is "L". And the loudness function on KIC9176/77P is on by sending the serial data.

VOLUME MUTE

1. PRINCIPAL FUNCTION

Down the volume level 20dB and the MUTE OUTPUT is outputted "L" and the MUTE-INDICATION OUTPUT is flashed at 1 Hz rate.

2. KEY AND I/O PORT TO BE USED

(MUTE) key, DATA OUTPUT, CK OUTPUT, STB-1 OUTPUT, STB-2 OUTPUT, MUTE-INDICATION OUTPUT

3. FUNCTIONS

- a. The on and off of the volume mute function is changed cyclically by pushing (MUTE) key.
- b. When the volume mute function is on, the actual volume level is down 20dB and the volume level mark on the LCD flash.
And the MUTE OUTPUT is "L" and the MUTE-INDICATION OUTPUT flash at 1 Hz rate.
These ports are on the KIC9174P.
- c. The (VR-UP) key is invalid when the volume mute function is on.

AUTO LEVEL DOWN

1. PRINCIPAL FUNCTION

The volume level is set -50dB automatically.

2. KEY TO BE USED

Nothing

3. FUNCTIONS

The volume level is set -50dB automatically, if the power is off when that level is more than -20dB.
This function is prevent the too big level of the volume of when the power is on.

KIC9309AF-044

CLOCK

1. PRINCIPAL FUNCTION

The clock of 12H and 24H displayed

2. KEY TO BE USED

(UP/MIN-ADJ.) key, (DOWN/HOUR-ADJ.) key, (DISPLAY) key, (MEMORY/CLOCK-ADJUSTMENT) key, T0, T1 jumper, clock-priority jumper.

3. FUNCTIONS

- a. The condition of the clock and the timer function is set as shown below according to setting of the T0, T1 jumper.

T0	T1	CLOCK	display at power off	TIMER
0	0	×	×	×
1	0	○	×	×
0	1	○	○	×
1	1	○	○	○

○ : enable × : no function

- b. The display is changed by pushing (DISPLAY) key in tuner mode as shown below, when the power is on.

T0/T1 = 0/0 The (DISPLAY) key is invalid.

T0/T1 = 1/0, 0/1

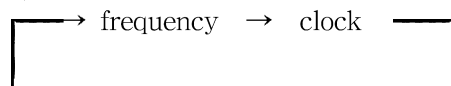

T0/T1 = 1/1

In case the timer OFF enable jumper is no set.

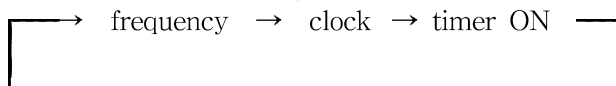

In case the timer OFF enable jumper is set.

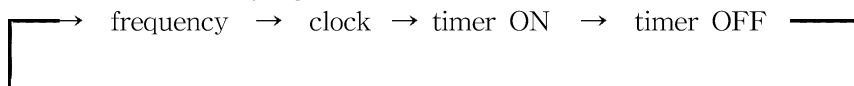

- c. In case of mode except tuner, the display and action of (DISPLAY) key is same as "b" when the diode. of clock priority jumper is no set. when that diode is set. the frequency display is nothing in the mode except tuner. In power is off, the (DISPLAY) key is valid only when timer is standby.
- d. The "CLOCK" mark on LCD is on in the clock display when the power is on.
In case the power is off, the "CLOCK" mark is not on.
- e. If the (MEMORY/CLOCK-ADJUSTMENT) key is pushed in clock display, the clock adjusting enable state is set for 1 minute. The "clock" mark on the LCD flashes at 1 Hz rate in the clock adjusting enable state. In that state. the hour of the clock is adjusted by pushing the (DOWN/HOUR-ADJ.) key, and the minute of clock is adjusted by pushing the (UP/MIN-ADJ.) key. when power is off, the (MEMORY/CLOCK-ADJUSTMENT) key is invalid.

KIC9309AF-044

f. When the (MEMORY/CLOCK-ADJUSTMENT) key is pushed in the clock adjusting enable state, the second of the clock is set to the zero and that state are released.

g. Setting the second to the zero is shown below

1. In case the (UP/MIN-ADJ.) (DOWN/HOUR-ADJ.) key is used in the clock adjusting enable state.

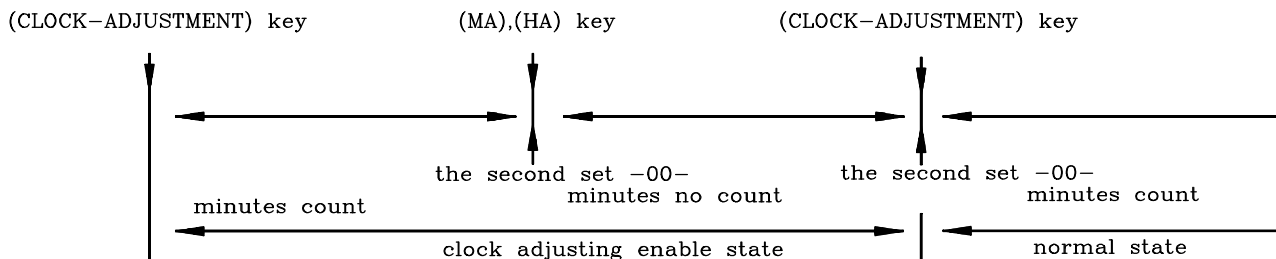

2. In case the (MEMORY(CLOCK-ADJUSTMENT)) key is pushed again within 1 minute from the setting the clock adjusting enable state.

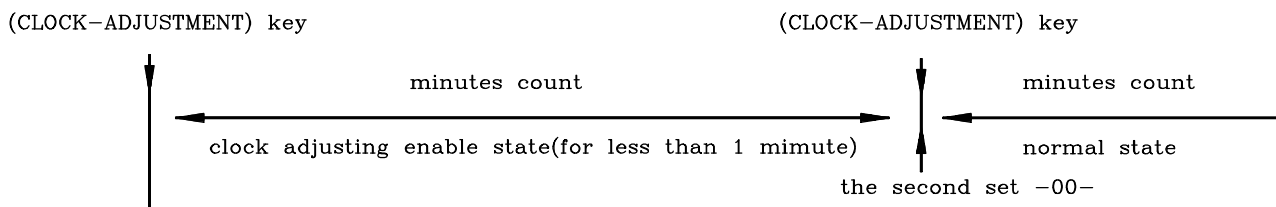

3. In case the (UP/MIN-ADJ.) (DOWN/HOUR-ADJ.) key is no used in the clock adjusting enable state for 1 minute.

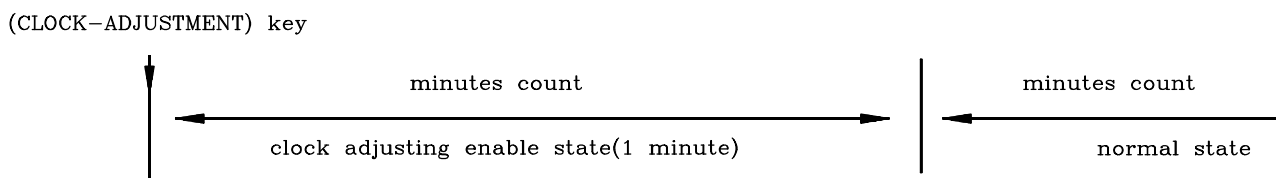

h. The minute or the hour step up by 1 step / 1 push, when the (UP/MIN-ADJ.) key or the (DOWN/HOUR-ADJ.) key is pushed for less than 500 ms in clock adjusting enable state. The minute or the hour step up continuously by 1 step / 250 ms. when the (UP/HOUR-ADJ.) key or the (DOWN/MIN-ADJ.) key is pushed for more than 500 ms.

i. If the (UP/HOUR-ADJ.) key, the (DOWN/MIN-ADJ.) key is not pushed for 1 minute in clock adjusting enable state, that state will be released. In this case, the second is not set the zero.

j. The clock is 24 H display in Europe area (A2/A1/A0)="000", "001".
In other area, the clock is 12 H display. (with "AM" and "PM" mark).

k. If the key related radio is pushed when those keys are valid in clock display, the display change to the frequency display and the action of the key pushed is executed.

l. If the (DISPLAY) key is pushed in the clock adjustment state, the state is released.

KIC9309AF-044

TIMER

1. PRINCIPAL FUNCTION

Power is on/off by timer.

2. KEY AND SWITCH TO BE USED

(UP/MIN-ADJ.) key, (DOWN/HOUR-ADJ.) key, (DISPLAY) key, (MEMORY/CLOCK-ADJUSTMENT) key, T0, T1 jumper, EVERY TIMER switch, timer OFF enable jumper.

3. FUNCTIONS

- a. The timer function is enable only in case the T0/T1 jumper is set 1/1.
- b. When the timer OFF enable jumper is set, the on/off timer can use.
But that jumper is no set, it is only the on timer.
- c. In case the AUTO TUNER jumper is set, the source is selected tuner always when power is on by on timer, In case the AUTO TUNER jumper is no set, the source is selected the last one.
- d. The display is changed by pushing (DISPLAY) key as shown below. (tuner mode)

In case of the power on. (T0/T1=1/1, timer OFF enable jumper=1)

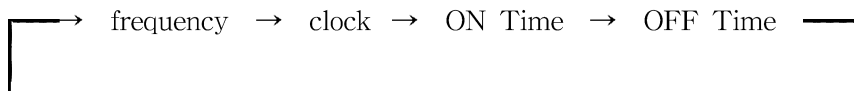

In case of the power on. (T0/T1=1/1, timer OFF enable jumper=0)

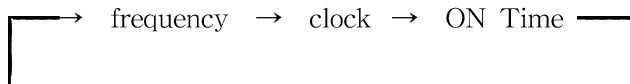

In case of the power off when the on timer has been set. (T0/T1=1/1, timer OFF enable jumper=1)



In case the on timer has been cleared at power off, the (display) key is invalid.

The (POWER) key on the KIC9243F is invalid, if the on timer has been set at the power off. But, in that case, the (DISPLAY) key is valid.

- e. The timer display is as shown below.

TIMER STATE	DISPLAY		
	TIMER mark	ON mark	OFF mark
ON TIME display	ON	flashing	OFF
OFF TIME display	ON	OFF	flashing
timer setting state of ON TIME	flashing	flashing	OFF
timer setting state of OFF TIME	flashing	ON	flashing
on timer & off timer are on	ON	ON	ON
on timer is on	ON	ON	OFF
power on by the on timer and the off timer is on	ON	OFF	ON

- f. The on time or off time display is displayed for 5 second. After 5 second, their display return back to the clock display. But, their display is kept during the timer setting state.

KIC9309AF-044

g. In case that the on timer has been cleared, the on time display is as shown below.

* on time display

TIMER ON
— : — —

* off time display

TIMER OFF
— : — —

In case that the on timer is set, the on time is shown on the on time display. The off time display is same as the off time display.

- h. It is in the on time setting state to push the (MEMORY/CLOCK-ADJ.) key in the on time display. In that state, the on time is displayed and can be adjusted by pushing the (UP/MIN-ADJ.) key or the (DOWN/HOUR-ADJ.) key. The way of adjusting time is same as the clock adjustment.
- i. When the clock has not adjusted (clock display flash at 1 Hz rate), the on/off time setting state can not be set. If the on timer has been cleared, the off time setting state can not be set.
- j. When the on time is changed, the off time is set same time automatically. And the off timer is cleared to set the same time.
- k. The on timer is set by pushing the (MEMORY/CLOCK-ADJ.) key in the on time setting state. The way of to set the off timer is same as the on timer.
- l. The off timer can not be set if the on time and off time are same.
- m. When the (MEMORY/CLOCK-ADJUSTMENT) key is pushed for more than 1 second on the on time display in case the on timer has been set, the on timer is cleared. The way of being cleared the off timer is same as the on timer.
- n. When the on timer is cleared by (MEMORY/CLOCK-ADJUSTMENT) key, the off timer is cleared automatically.
- o. In case the on time is set and the on time is no changed when the on/off timer had been cleared, the last state of setting of on/off timer is set.

* The way of to set the on timer.  TIMER : flash at 1 Hz rate.
^ ^ ^ ^ ^

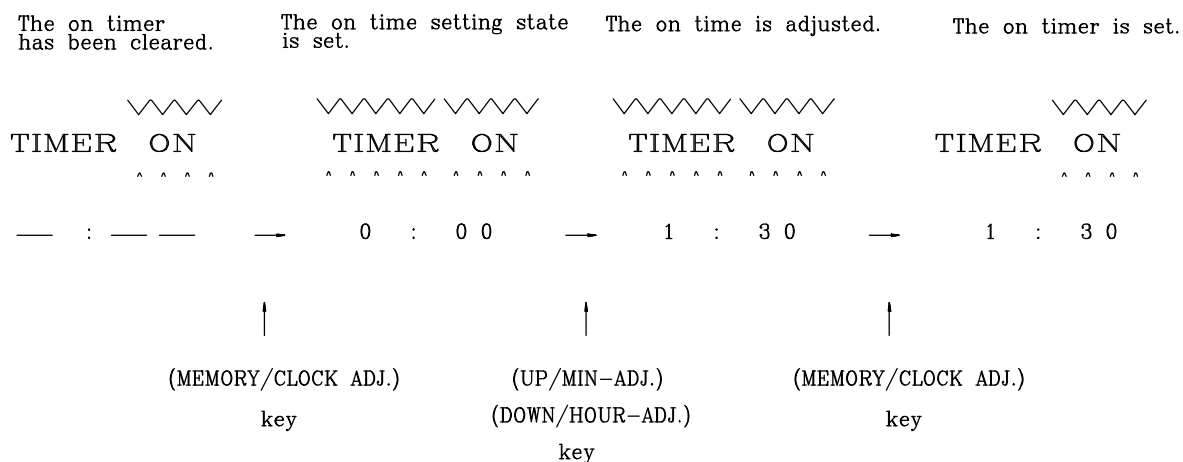

KIC9309AF-044

* The way of to set the on/off timer.

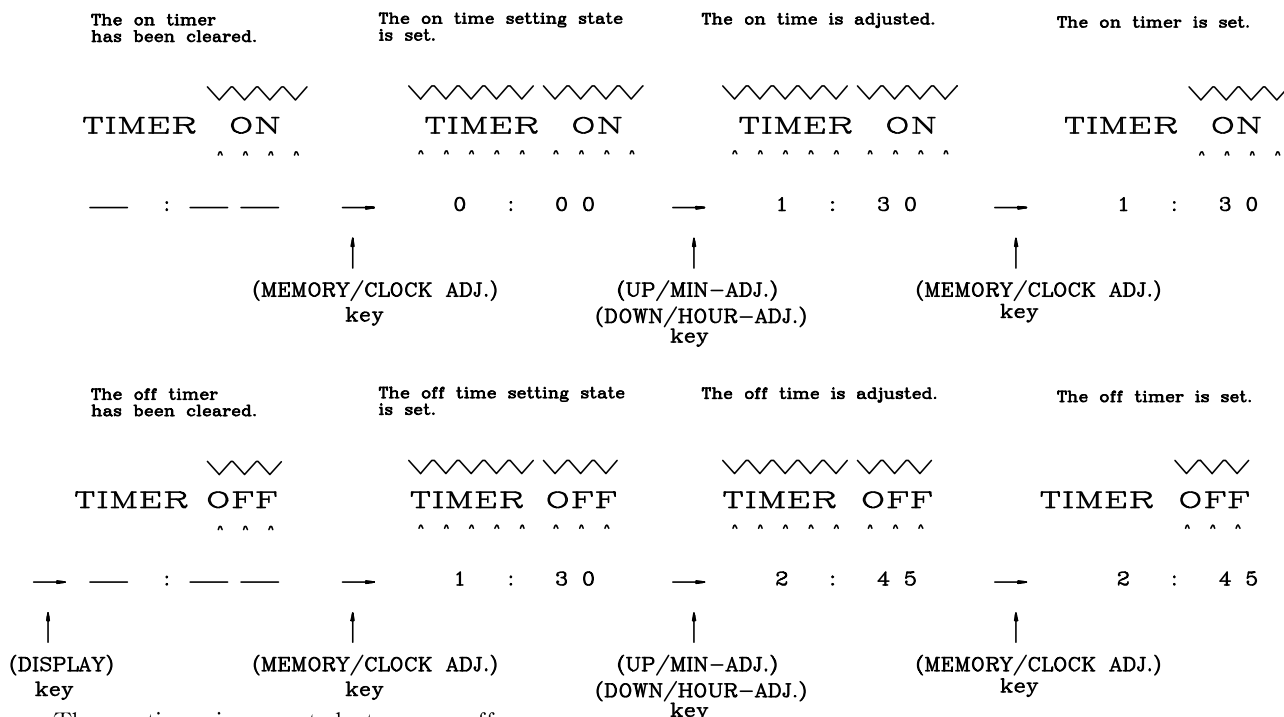

p. The on timer is executed at power off.

q. The off timer is executed only when the power had been on by on timer.

r. The actions of the timer function are as shown below.

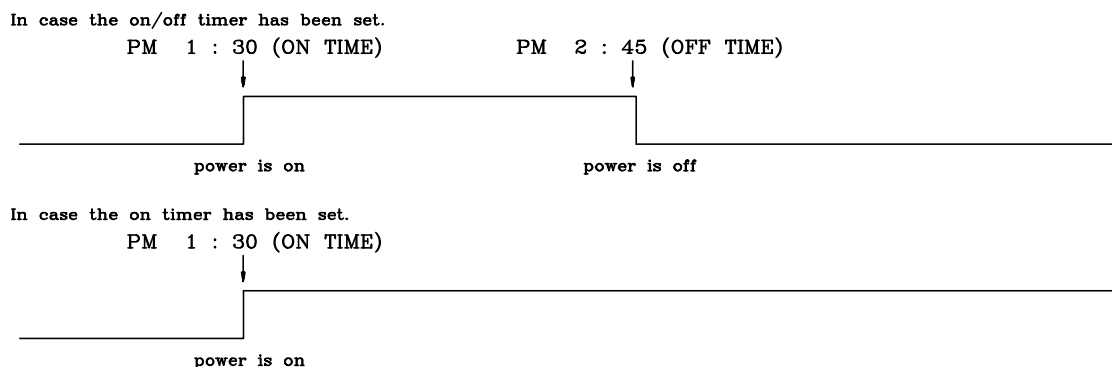

s. If the (POWER) key is pushed when the power has been on by on timer and off timer is set, the actions of the timer function are as shown below.

* In case that the EVERY TIMER switch is off.

When the (POWER) key is pushed, the power is off and the on/off timer is cleared.

* In case that the EVERY TIMER switch is on.

When the (POWER) key is pushed, only the power is off. The on/off timer are kept.

t. If the (POWER) key is pushed at the power off when the on timer has been set, only the power is on. The on/off timer is kept.

u. The actions of the timer function after the on/off timer was executed, is as shown below.

* In case the EVERY TIMER switch is on, the on/off timer is not cleared after the timer was executed.

* In case the EVERY TIMER switch is off, the on/off timer is cleared after the timer was executed.

The on/off timer set is valid only one time.

v. If the (DISPLAY) key is pushed in the on/off time setting state, the setting state is only released.

SLEEP

1. PRINCIPAL FUNCTION

The power is off after sleep time.

2. KEY AND SWITCH TO BE USED

(SLEEP) key

3. FUNCTIONS

- a. When the (SLEEP) key is pushed, the sleep function is set and the sleep time is displayed for 5 seconds.
- b. The power is automatically on if the (SLEEP) key is pushed at power off.
- c. The sleep time is changed as shown below, every pushing the (SLEEP) key during the sleep time is displayed.

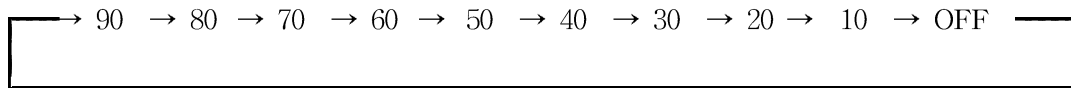

- d. The SLEEP mark is on during the sleep function is set.
- e. The sleep function is cleared, if the (SLEEP) key was pushed when the sleep time is not displayed and sleep function is set.
- f. The power is automatically off after sleep time, when sleep function is set.

KIC9309AF-044

INITIALIZE

1. PRINCIPAL FUNCTION

setting initial state when the power supply is on.

2. KEY TO BE USED

Nothing

3. FUNCTIONS

a. The content of the preset memory is set as shown below.

BAND	AREA	PRESET MEMORY					UNIT
FM	FIXED MEMORY	M1	M2	M3	M4	M5	MHz
	RANDOM MEMORY	M1	M2	M3	M4	M5	
	EUROPE SOUTH AMERICA	87.50	90.10	98.10	106.10	108.00	
	USA 1	87.5	90.1	98.1	106.1	108.1	
	USA 2 AUSTRALIA MIDDLE AND NEAR EAST LATIN AMERICA	87.5	90.1	98.1	106.1	108.0	
	JAPAN	76.0	80.0	83.0	86.0	90.0	
MW	FIXED MEMORY	M1	M2	M3	M4	M5	kHz
	RANDOM MEMORY	M11	M12	M13	M14	M15	
	EUROPE	522	612	999	1404	1620	
	USA 1, 2	520	610	1000	1400	1720	
	LATIN AMERICA	520	610	1000	1400	1620	
	AUSTRALIA MIDDLE AND NEAR EAST LATIN AMERICA	531	612	999	1404	1602	
	JAPAN	522	612	999	1404	1629	
LW	FIXED MEMORY	M1	M2	M3	M4	M5	kHz
	RANDOM MEMORY	M16	M17	M18	M19	M20	
	EUROPE	146	164	218	272	281	

b. The receiving band is set FM. (FM 1)

c. The level of the volume is set 50 (dB).

d. The loudness function is set to be off, The MONO function is set to be off.

e. The time of the clock is set "0:00" in case of the Europe area, "AM 12:00" in case of the other area.

f. The source is selected tuner.

KIC9309AF-044

THE ACTION OF WHEN A KEY PUSHED DURING THE FUNCTION IS EXECUTING.

a. In case of the memory scan function and the auto tuning function.

KEY	DURING THE MEMORY SCAN FUNCTION	DURING THE AUTO TUNING FUNCTION
M1 ~ M10	The function is stopped and the action of the key pushed is executed.	
UP	The function is stopped and the action of the key pushed is executed.	If the direction of the auto tuning and the direction of the key pushed is the same, the auto tuning is stopped and the function of key pushed is not executed. But, if it is different, the auto tuning is stopped and the function of key pushed is executed.
DOWN		
MEMORY	INVALIDITY	
BAND / FM	The function is stopped and the action of the key pushed is executed.	
MW		
LW		
SLEEP		
MEMORY SCAN	Only the function is stopped.	The function is stopped and the action of the key pushed is executed.
MONO	The function is not stopped and the action of the key pushed is executed.	
DISPLAY	INVALID	
VR-UP	The function is not stopped and the action of the key pushed is executed.	
VR-DOWN		
MUTE		
LOUDNESS		
POWER	The function is stopped and the action of the key pushed is executed	
CD	The function is stopped and the action of the key pushed is executed.	The function is stopped and the receiving frequency return back to the frequency of when the auto tuning was started. And the action of the key pushed is executed.
PHONO		
TUNER		
TV		
VCR		
AUX		
TAPE		

KIC9309AF-044

b. In case of the memory writing enable state and the clock adjusting enable state.

KEY	MEMORY WRITING ENABLE STATE	CLOCK ADJUSTING ENABLE STATE
M1 ~ M10	The receiving station is memorized in the memory of the key pushed.	INVALID
UP	The state is released and the action of key pushed is executed.	The minutes is adjusted.
DOWN		The hour is adjusted.
MEMORY	The state is released.	The second is reset, and the state is released.
BAND / FM	The state is released and the action of the key pushed is executed.	
MW		
LW		
SLEEP		
MEMORY SCAN		
MONO	The state is not released and the action of key pushed is executed.	
DISPLAY	The state is released and the action of key pushed is executed.	The state is only released.
VR-UP	The state is not released and the action of key pushed is executed.	
VR-DOWN		
MUTE		
LOUDNESS		
POWER	The state is released and the action of the key pushed is executed	
CD	The state is released and the action of the key pushed is executed.	The state is not released and the action of the key pushed is executed.
PHONO		
TUNER		
TV		
VCR		
AUX		
TAPE		

KIC9309AF-044

KIC9309AF-044 TIMING.

- PLL The timing to set the PLL data
- PLL off The timing to stop the PLL
- DISP The timing to set the display data
- IO timing to the outputs of the I/O ports (PIN47~PIN61)
- OUT. timing to the outputs of the out ports (PIN43~PIN46)
- 1'st. The timing to check the IF frequency (The IF tolerance is WIDE)
- 2'nd. The timing to check the IF frequency (The IF tolerance is NARROW)
- SIO. The timing to set to sio data

CAUTION !!) If there is not instruction about the numerical value, their unit is milliseconds.

1. $\overline{\text{INI}}$

$\overline{\text{INI}}$ "L" \rightarrow "H" ($\overline{\text{INH}} = \text{"H"}$)

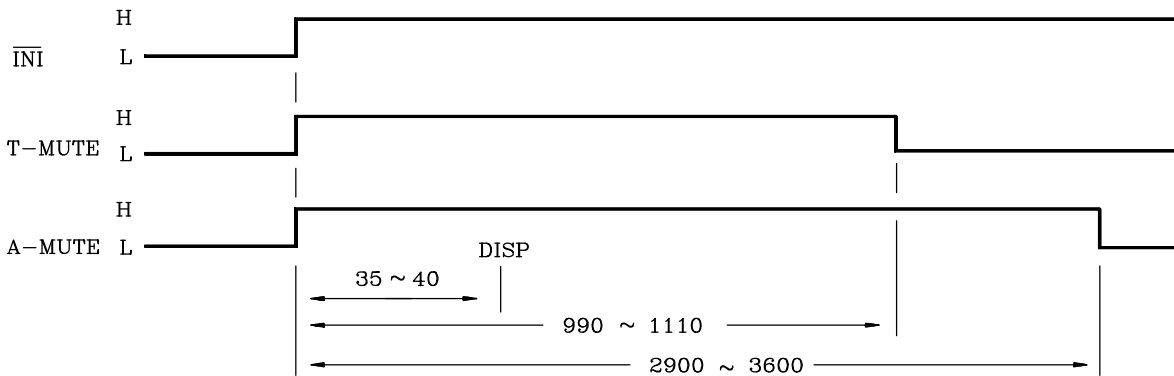

2. POWER ON

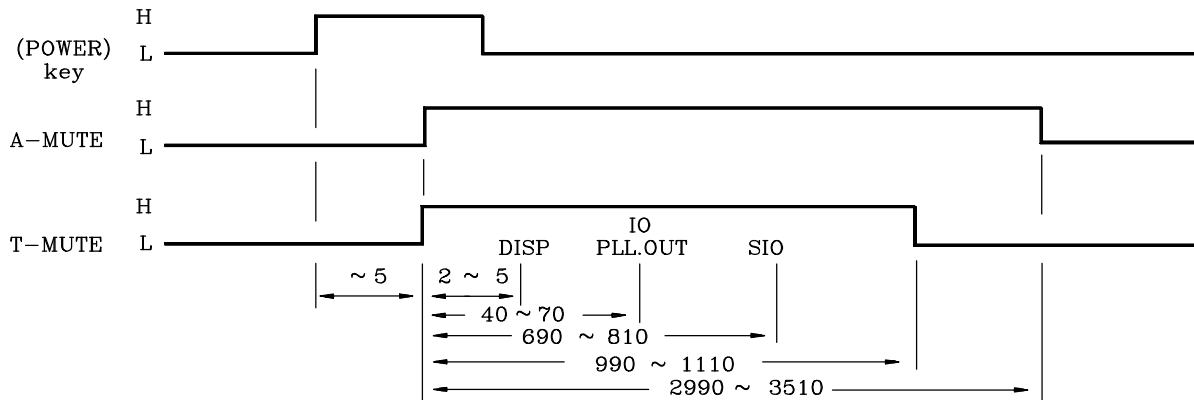

KIC9309AF-044

3. POWER OFF

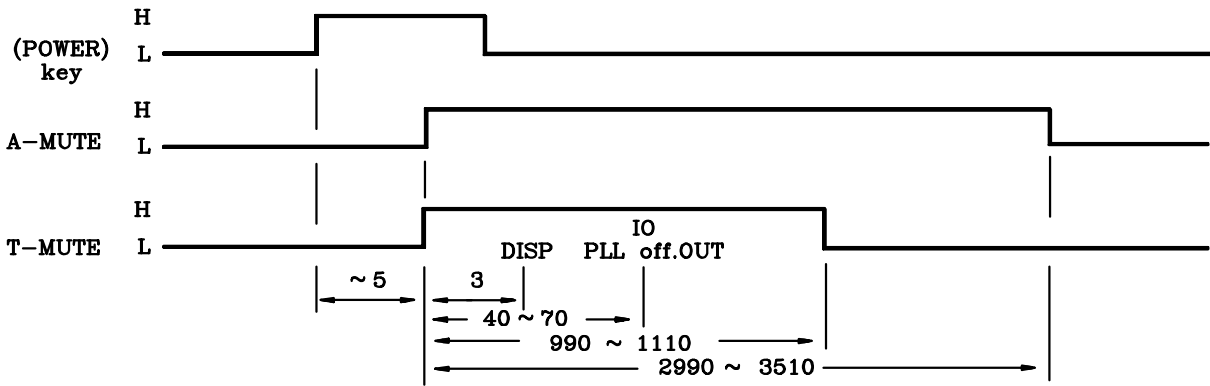

4. FUNCTION CHANGE

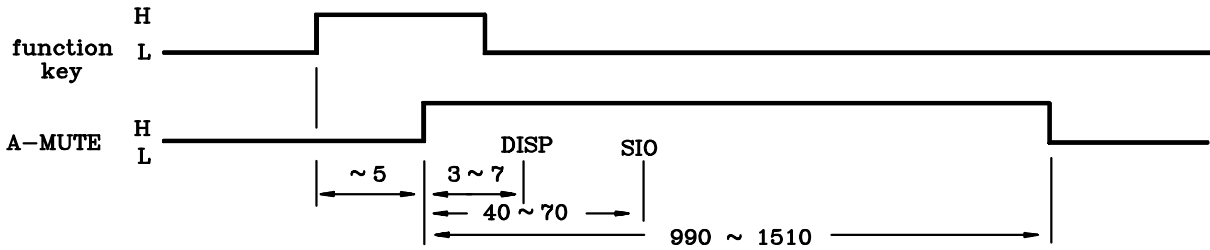

* function key : (TAPE)key. (TUNER)key. (AUX)key. (PHONO)key. (CD)KEY. (VCR)key. (TV)key

5. BAND CHANGE

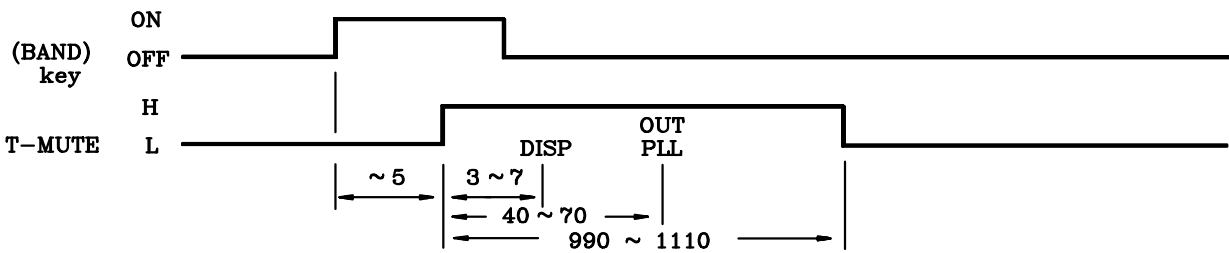

6. TUNING

a. In case of 1 STEP/1 PUSH within 500 ms

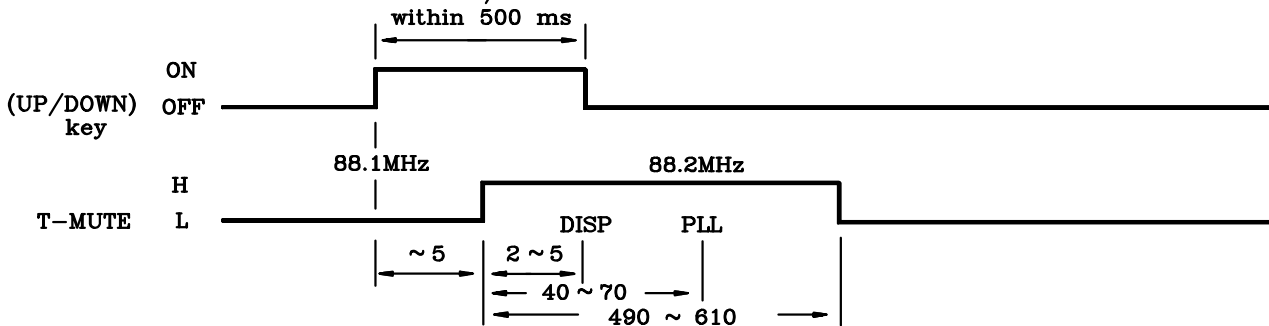

KIC9309AF-044

b. In case of pushing continue

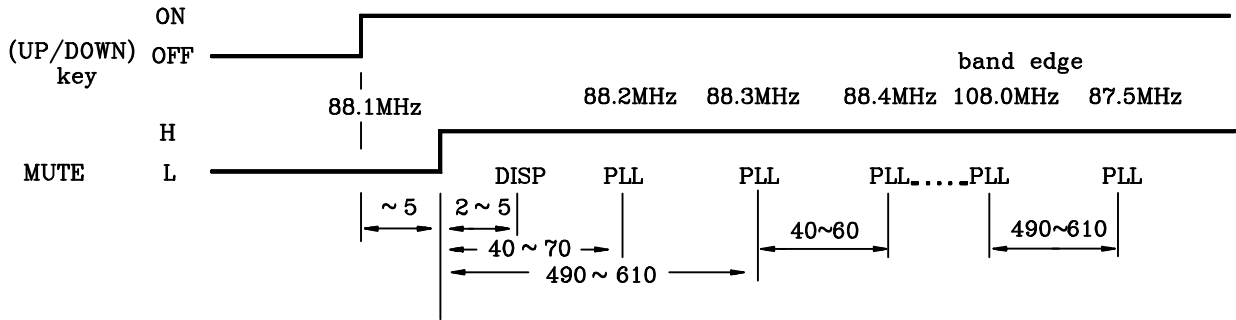

c. DURING SEARCH TUNING

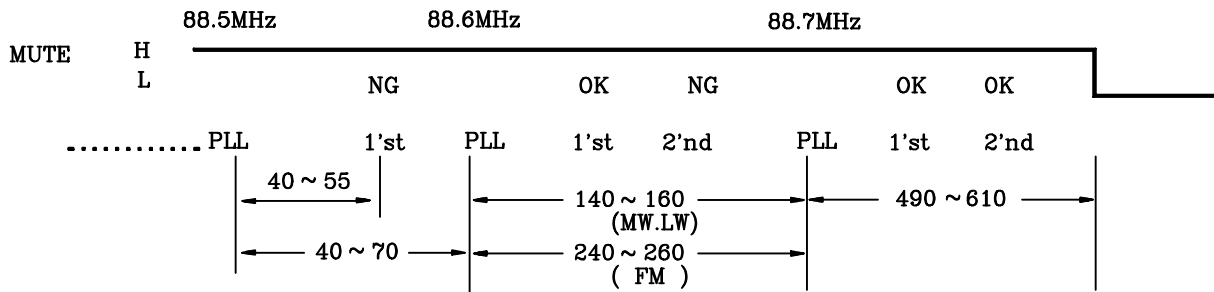

7. PRESET MEMORY

In case of calling the preset memory directly (In case that band dose not changed)

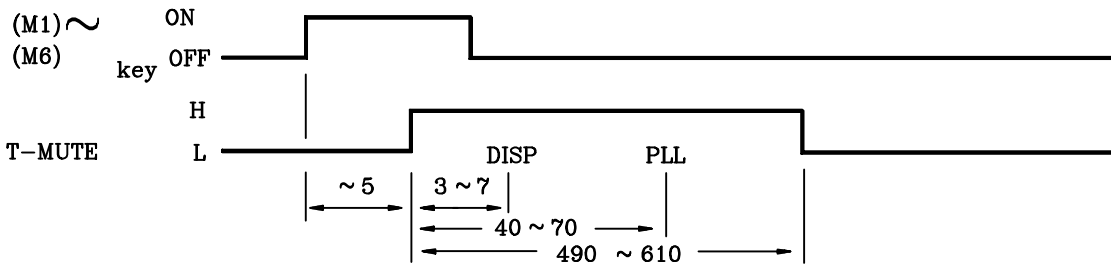

In case of calling the preset memory directly (In case that band changed)

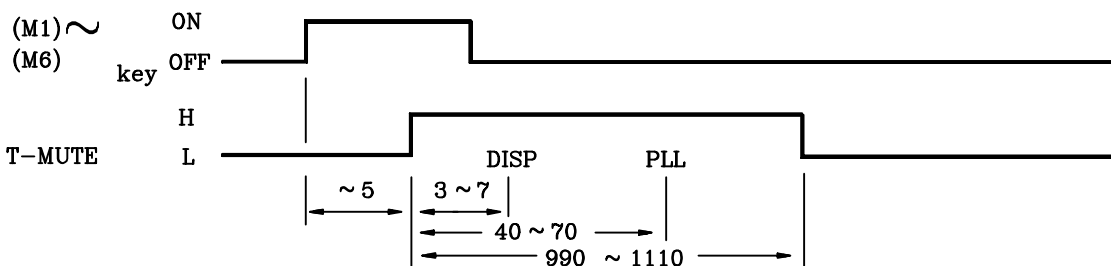

KIC9309AF-044

8. MEMORY SCAN (In case that band dose net changed)

same band

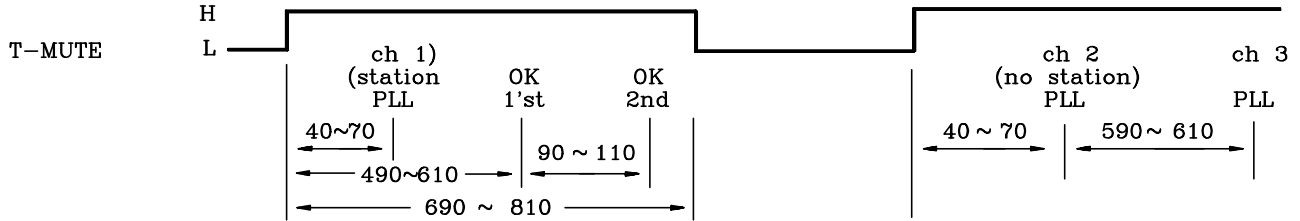

different band

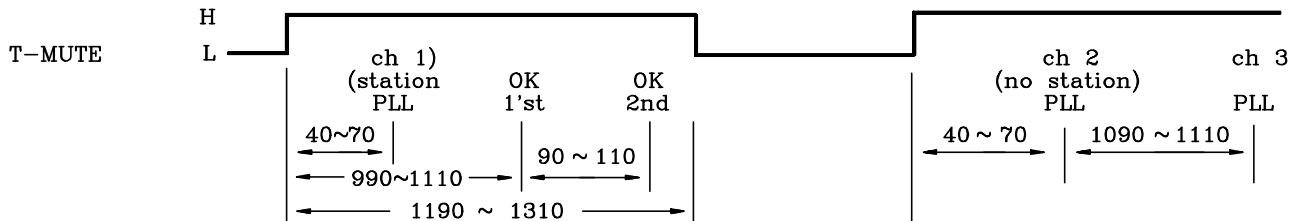

9. VOLUME UP/DOWN

In case of 1 STEP/1 PUSH

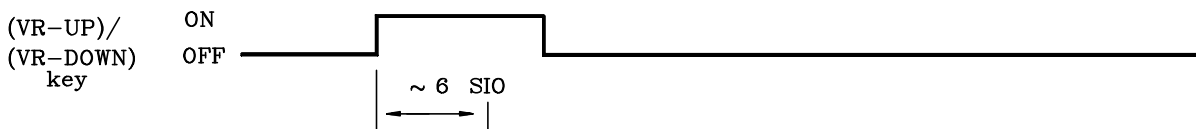

In case of pushing continue

