

# KA5Q-SERIES

KA5Q0765RT/KA5Q12656RT/KA5Q1265RF/

KA5Q1565RF

## Fairchild Power Switch(FPS)

### Features

- Quasi Resonant Converter Controller
- Internal Burst Mode Controller for Stand-by Mode
- Pulse by Pulse Current Limiting
- Over Current Latch Protection
- Over Voltage Protection (Vsync: Min. 11V)
- Internal Thermal Shutdown Function
- Under Voltage Lockout
- Internal High Voltage Sense FET
- Auto-Restart Mode

### Description

The Fairchild Power Switch(FPS) product family is specially designed for an off-line SMPS with minimal external components. The Fairchild Power Switch(FPS) consist of high voltage power SenseFET and current mode PWM controller IC. PWM controller features integrated fixed oscillator, under voltage lock out, leading edge blanking, optimized gate turn-on/turn-off driver, thermal shut down protection, over voltage protection, temperature compensated precision current sources for loop compensation and fault protection circuit. compared to discrete MOSFET and controller or RCC switching converter solution, a Fairchild Power Switch(FPS) can reduce total component count, design size, and weight and at the same time increase & efficiency, productivity, and system reliability. It has a basic platform well suited for cost-effective design in quasi resonant converter as C-TV power supply.

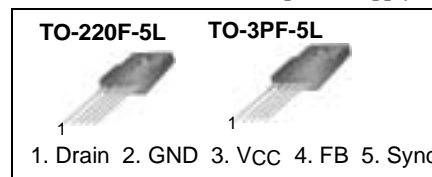

### Internal Block Diagram

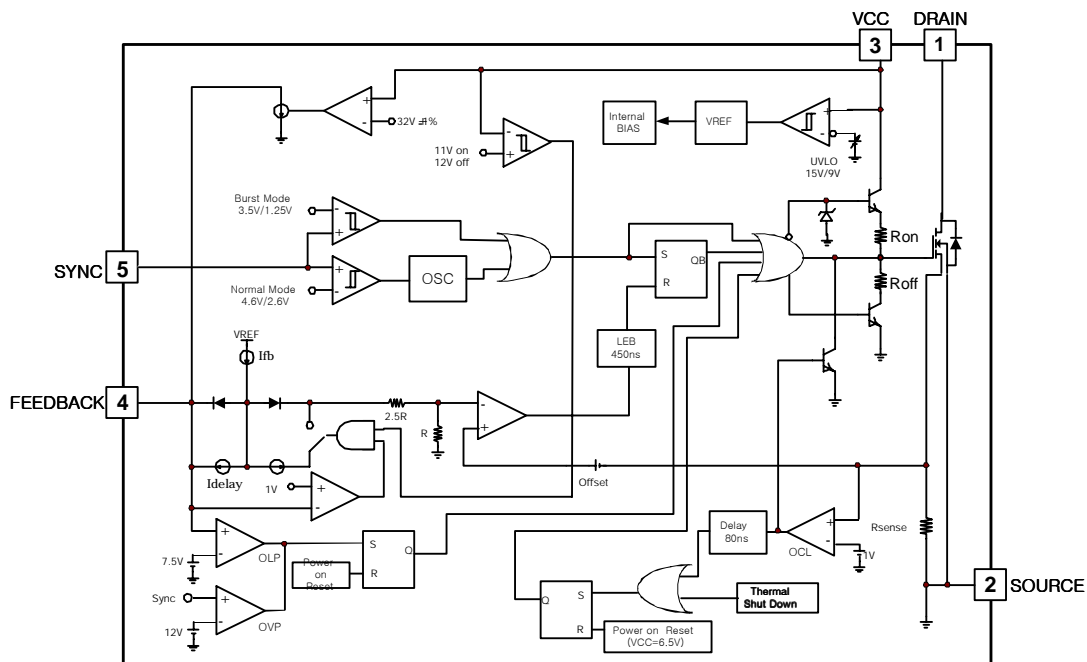

Rev.1.0.3

## Absolute Maximum Ratings

(Ta=25°C, unless otherwise specified)

Characteristic	Symbol	Value	Unit
<b>KA5Q0765RT</b>			
Drain-Gate Voltage(RGS=1MΩ)	VDGR	650	V
Gate-Source(GND) Voltage	VGS	±30	V
Drain Current Pulsed <sup>(1)</sup>	IDM	28	ADC
Continuous Drain Current (Tc = 25°C)	ID	7.0	ADC
Continuous Drain Current (Tc = 100°C)	ID	5.6	ADC
Single Pulsed Avalanch Current <sup>(3)</sup> (Energy <sup>(2)</sup> )	IAS(EAS)	20(570)	A(mJ)
Maximum Supply Voltage	VCC,MAX	40	V
Input Voltage Range	VFB	-0.3 to VCC	V
	VSynC	-0.3 to 13	V
Total Power Dissipation	PD	47	W
	Derating	0.37	W/°C
Operating Junction Temperature.	TJ	+160	°C
Operating Ambient Temperature.	TA	-25 to +85	°C
Storage Temperature Range.	TSTG	-55 to +150	°C
Thermal Resistance	Rthjc	2.7	°C/W
<b>KA5Q12656RT</b>			
Drain-Gate Voltage(RGS=1MΩ)	VDGR	650	V
Gate-Source(GND) Voltage	VGS	±30	V
Drain Current Pulsed <sup>(1)</sup>	IDM	48	ADC
Continuous Drain Current (Tc = 25°C)	ID	12	ADC
Continuous Drain Current (Tc = 100°C)	ID	8.4	ADC
Single Pulsed Avalanch Current(Energy <sup>(2)</sup> )	IAS(EAS)	30(950)	A(mJ)
Maximum Supply Voltage	VCC,MAX	40	V
Input Voltage Range	VFB	-0.3 to VCC	V
	VSynC	-0.3 to 13	V
Total Power Dissipation	PD	55	W
	Derating	0.4	W/°C
Operating Junction Temperature.	TJ	+160	°C
Operating Ambient Temperature.	TA	-25 to +85	°C
Storage Temperature Range.	TSTG	-55 to +150	°C
Thermal Resistance	Rthjc	2.5	°C/W

## Absolute Maximum Ratings (Continued)

(Ta=25°C, unless otherwise specified)

Characteristic	Symbol	Value	Unit
<b>KA5Q1265RF</b>			
Drain-Gate Voltage(R <sub>GS</sub> =1MΩ)	V <sub>DGR</sub>	650	V
Gate-Source(GND) Voltage	V <sub>GS</sub>	±30	V
Drain Current Pulsed <sup>(1)</sup>	I <sub>DM</sub>	48	ADC
Continuous Drain Current (T <sub>c</sub> = 25°C)	I <sub>D</sub>	12	ADC
Continuous Drain Current (T <sub>c</sub> = 100°C)	I <sub>D</sub>	8.4	ADC
Single Pulsed Avalanch Current(Energy <sup>(2)</sup> )	I <sub>AS</sub> (EAS)	33(950)	A(mJ)
Maximum Supply Voltage	V <sub>CC,MAX</sub>	40	V
Input Voltage Range	V <sub>FB</sub>	-0.3 to V <sub>CC</sub>	V
	V <sub>Sync</sub>	-0.3 to 13	V
Total Power Dissipation	P <sub>D</sub>	95	W
	Derating	0.76	W/°C
Operating Junction Temperature.	T <sub>J</sub>	+160	°C
Operating Ambient Temperature.	T <sub>A</sub>	-25 to +85	°C
Storage Temperature Range.	T <sub>STG</sub>	-55 to +150	°C
Thermal Resistance	R <sub>thjc</sub>	1.31	°C/W

<b>KA5Q1565RF</b>			
Drain-Gate Voltage(R <sub>GS</sub> =1MΩ)	V <sub>DGR</sub>	650	V
Gate-Source(GND) Voltage	V <sub>GS</sub>	±30	V
Drain Current Pulsed <sup>(1)</sup>	I <sub>DM</sub>	60	ADC
Continuous Drain Current (T <sub>c</sub> = 25°C)	I <sub>D</sub>	15	ADC
Continuous Drain Current (T <sub>c</sub> = 100°C)	I <sub>D</sub>	12.0	ADC
Single Pulsed Avalanch Current(Energy <sup>(2)</sup> )	I <sub>AS</sub> (EAS)	36(1050)	A(mJ)
Maximum Supply Voltage	V <sub>CC,MAX</sub>	40	V
Input Voltage Range	V <sub>FB</sub>	-0.3 to V <sub>CC</sub>	V
	V <sub>Sync</sub>	-0.3 to 13	V
Total Power Dissipation	P <sub>D</sub>	98	W
	Derating	0.78	W/°C
Operating Junction Temperature.	T <sub>J</sub>	+160	°C
Operating Ambient Temperature.	T <sub>A</sub>	-25 to +85	°C
Storage Temperature Range.	T <sub>STG</sub>	-55 to +150	°C
Thermal Resistance	R <sub>thjc</sub>	1.28	°C/W

**Note:**

1. Repetitive rating : Pulse width limited by maximum junction temperature
2. L = 10mH, V<sub>DD</sub> =50V, R<sub>G</sub> = 27Ω, starting T<sub>j</sub> = 25°C
3. L = 13uH, starting T<sub>j</sub> = 25°C

## Electrical Characteristics (SFET part)

(Ta=25°C unless otherwise specified)

Parameter	Symbol	Conditions	Min.	Typ.	Max.	Unit
<b>KA5Q0765RT</b>						
Drain-Source Breakdown Voltage	BVDSS	VGS=0V, ID=50μA	650	-	-	V
Zero Gate Voltage Drain Current	IDSS	VDS=Max., Rating, VGS=0V	-	-	200	μA
		VDS=0.8Max., Rating, VGS=0V, TC=85°C	-	-	300	μA
Static Drain-Source on Resistance <sup>(1)</sup>	RDS(on)	VGS=10V, ID=4.0A	-	1.3	1.6	Ω
Input Capacitance	Ciss	VGS=0V, VDS=25V, f = 1MHz	-	1110	-	pF
Output Capacitance	Coss		-	105	-	
Reverse Transfer Capacitance	Crss		-	50	-	
Turn on Delay Time	td(on)	VDD=0.5BVDSS, ID=7.0A (MOSFET switching time are essentially independent of operating temperature)	-	25	-	nS
Rise Time	tr		-	55	-	
Turn Off Delay Time	td(off)		-	80	-	
Fall Time	tf		-	50	-	
Total Gate Charge (Gate-Source+Gate-Drain)	Qg	VGS=10V, ID=7.0A, VDS=0.5BVDSS(MOSFET Switching time are Essentially independent of Operating temperature)	-	57	74	nC
Gate-Source Charge	Qgs		-	9.3	-	
Gate-Drain (Miller) Charge	Qgd		-	29.3	-	
<b>KA5Q12656RT/KA5Q1265RF</b>						
Drain-Source Breakdown Voltage	BVDSS	VGS=0V, ID=50μA	650	-	-	V
Zero Gate Voltage Drain Current	IDSS	VDS=Max., Rating, VGS=0V	-	-	200	μA
		VDS=0.8Max., Rating, VGS=0V, TC=85°C	-	-	300	μA
Static Drain-Source on Resistance <sup>(1)</sup>	RDS(on)	VGS=10V, ID=6A	-	0.7	0.9	Ω
Input Capacitance	Ciss	VGS=0V, VDS=25V, f = 1MHz	-	1820	-	pF
Output Capacitance	Coss		-	185	-	
Reverse Transfer Capacitance	Crss		-	32	-	
Turn on Delay Time	td(on)	VDD=0.5BVDSS, ID=12.0A (MOSFET switching time are essentially independent of operating temperature)	-	38	-	nS
Rise Time	tr		-	120	-	
Turn Off Delay Time	td(off)		-	200	-	
Fall Time	tf		-	100	-	
Total Gate Charge (Gate-Source+Gate-Drain)	Qg	VGS=10V, ID=12.0A, VDS=0.5BVDSS(MOSFET Switching time are Essentially independent of Operating temperature)	-	60	78	nC
Gate-Source Charge	Qgs		-	10	-	
Gate-Drain (Miller) Charge	Qgd		-	30	-	

## Absolute Maximum Ratings (SFET Part)

(Ta=25°C, unless otherwise specified)

Characteristic	Symbol	Test condition	Min.	Typ.	Max.	Unit
<b>KA5Q1565RF</b>						
Drain-Source Breakdown Voltage	BVDSS	VGS=0V, ID=50μA	650	-	-	V
Zero Gate Voltage Drain Current	IDSS	VDS=Max., Rating, VGS=0V	-	-	200	μA
		VDS=0.8Max., Rating, VGS=0V, TC=85°C	-	-	300	μA
Static Drain-Source on Resistance <sup>(Note)</sup>	RDS(ON)	VGS=10V, ID=7.3A	-	0.5	0.65	W
Input Capacitance	Ciss	VGS=0V, VDS=25V, f=1MHz	-	2580	-	pF
Output Capacitance	Coss		-	270	-	
Reverse Transfer Capacitance	Crss		-	50	-	
Turn on Delay Time	td(on)	VDD=0.5BVDSS, ID=14.6A (MOSFET switching time are essentially independent of operating temperature)	-	50	-	nS
Rise Time	tr		-	155	-	
Turn Off Delay Time	td(off)		-	270	-	
Fall Time	tf		-	125	-	
Total Gate Charge (Gate-Source+Gate-Drain)	Qg	VGS=10V, ID=14.6A, VDS=0.8BVDSS (MOSFET switching time are essentially independent of operating temperature)	-	90	117	nC
Gate-Source Charge	Qgs		-	15	-	
Gate-Drain (Miller) Charge	Qgd		-	45	-	

### Note:

1. Pulse test: Pulse width ≤ 300μS, duty cycle ≤ 2%

## Electrical Characteristics (Control Part)

(Ta=25°C unless otherwise specified)

Parameter	Symbol	Conditions	Min.	Typ.	Max.	Unit
<b>UVLO SECTION</b>						
Start Threshold Voltage	V <sub>START</sub>	V <sub>FB</sub> =GND	14	15	16	V
Stop Threshold Voltage	V <sub>STOP</sub>	V <sub>FB</sub> =GND	8	9	10	V
<b>OSCILLATOR SECTION</b>						
Initial Frequency	F <sub>OSC</sub>	-	18	20	22	kHz
Voltage Stability	F <sub>STABLE</sub>	12V ≤ V <sub>CC</sub> ≤ 23V	0	1	3	%
Temperature Stability (Note2)	ΔF <sub>OSC</sub>	-25°C ≤ Ta ≤ 85°C	0	±5	±10	%
Maximum Duty Cycle	D <sub>MAX</sub>	-	92	95	98	%
Minimum Duty Cycle	D <sub>MIN</sub>	-	-	-	0	%
<b>FEEDBACK SECTION</b>						
Feedback Source Current	I <sub>FB</sub>	V <sub>FB</sub> =GND	0.7	0.9	1.1	mA
Shutdown Feedback Voltage	V <sub>SD</sub>	V <sub>FB</sub> ≥ 6.9V	6.9	7.5	8.1	V
Shutdown Delay Current	I <sub>DELAY</sub>	V <sub>FB</sub> =5V	4	5	6	μA
<b>SYNC. SECTION</b>						
Normal Sync High Threshold Voltage	V <sub>NSH</sub>	V <sub>CC</sub> =16V, V <sub>fb</sub> =5V	4.0	4.6	5.2	V
Normal Sync Low Threshold Voltage	V <sub>NSL</sub>	V <sub>CC</sub> =16V, V <sub>fb</sub> =5V	2.3	2.6	2.9	V
Burst Sync High Threshold Voltage	V <sub>BSH</sub>	V <sub>CC</sub> =10.5V, V <sub>fb</sub> =0V	3.2	3.6	4.0	V
Burst Sync Low Threshold Voltage	V <sub>BSL</sub>	V <sub>CC</sub> =10.5V, V <sub>fb</sub> =0V	1.1	1.3	1.5	V
<b>BURST MODE SECTION</b>						
Burst Mode Low Threshold Voltage	V <sub>BURL</sub>	V <sub>FB</sub> =0V	10.4	11.0	11.6	V
Burst Mode High Threshold Voltage	V <sub>BURH</sub>	V <sub>FB</sub> =0V	11.4	12.0	12.6	V
Burst Mode Enable Feedback Voltage	V <sub>BEN</sub>	V <sub>CC</sub> =10.5V	0.7	1.0	1.3	V
Burst Mode Peak Current Limit(Note4)	I <sub>BURPK</sub>	V <sub>CC</sub> =10.5V, V <sub>FB</sub> =0V	0.65	0.85	1.1	A
<b>CURRENT LIMIT(SELF-PROTECTION)SECTION</b>						
Peak Current Limit (Note4)	I <sub>OVER</sub>	KA5Q0765RT	4.40	5.00	5.60	A
		KA5Q12656RT	5.28	6.00	6.72	
		KA5Q1265RF	7.04	8.00	8.96	
		KA5Q1565RF	10.12	11.50	12.88	
<b>PROTECTION SECTION</b>						
Over Voltage Protection	V <sub>OV</sub> P	V <sub>SYNC</sub> ≥ 11V	11	12	13	V
Over Current Latch voltage(Note3)	V <sub>OCL</sub>	-	0.9	1.0	1.1	V
Thermal Shutdown Tempature(Note2)	T <sub>SD</sub>	-	140	160	-	°C

**Electrical Characteristics (Control Part)** (Continued)

(Ta=25°C unless otherwise specified)

Parameter	Symbol	Conditions	Min.	Typ.	Max.	Unit
<b>TOTAL DEVICE SECTION</b>						
Start Up Current	I <sub>START</sub>	V <sub>FB</sub> =GND, V <sub>CC</sub> =14V	-	0.1	0.2	mA
Operating Supply Current(Note1)	I <sub>OP</sub>	V <sub>FB</sub> =GND, V <sub>CC</sub> =16V	-	10	18	mA
	I <sub>OP(MIN)</sub>	V <sub>FB</sub> =GND, V <sub>CC</sub> =12V				
	I <sub>OP(MAX)</sub>	V <sub>FB</sub> =GND, V <sub>CC</sub> =28V				
<b>PRIMARY SIDE REGULATION SECTION (ONLY KA5Q0765RT/KA5Q12656RT)</b>						
Primary Regulation Threshold Voltage	V <sub>PR</sub>	I <sub>FB</sub> =700uA, V <sub>FB</sub> =4V	32.0	32.5	33.0	V
Primary Regulation Transconductance	G <sub>PR</sub>	-	2.0	2.6	-	mA/V

**Note:**

1. These parameters is the Current Flowing in the Control IC.
2. These parameters, although guaranteed, are not 100% tested in production
3. These parameters, although guaranteed, are tested in EDS(wafer test) process
4. These parameters are indicated Inductor Current.

## Typical Performance Characteristics

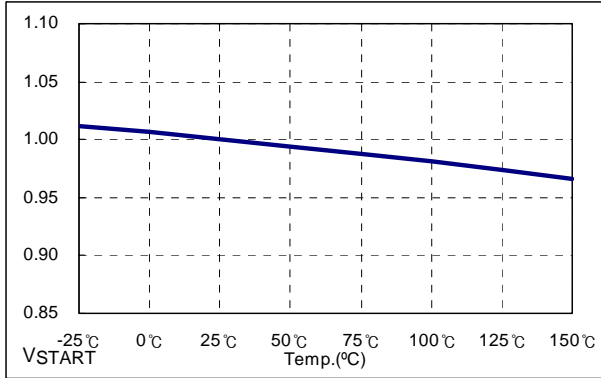

Figure 1. Start Threshold Voltage

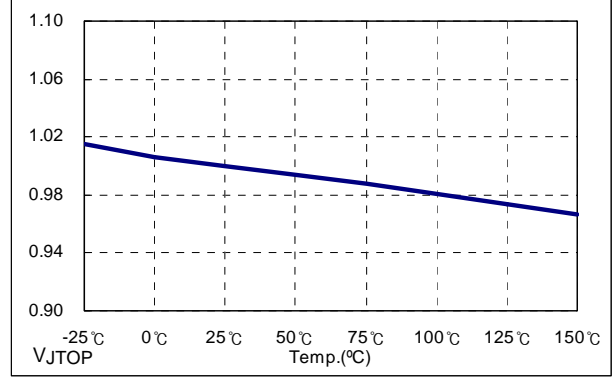

Figure 2. Stop Threshold Voltage

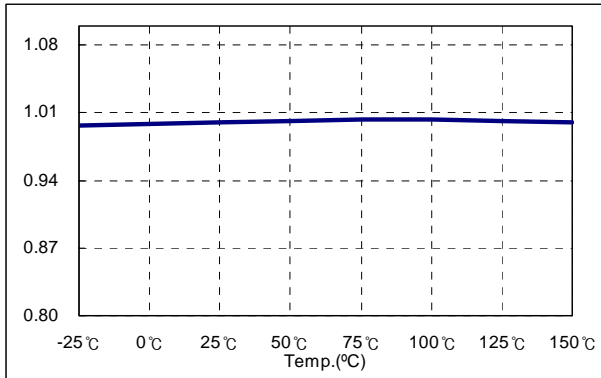

Figure 3. Start Up Current

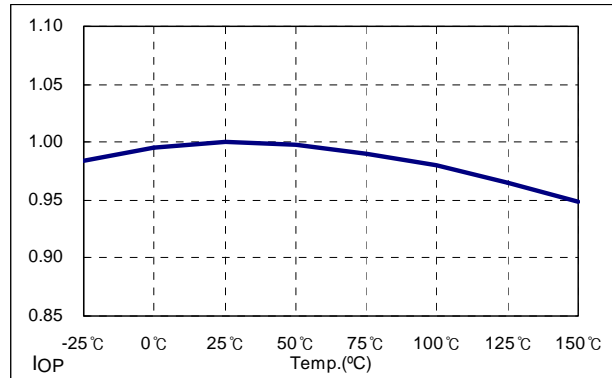

Figure 4. Operating Supply Current

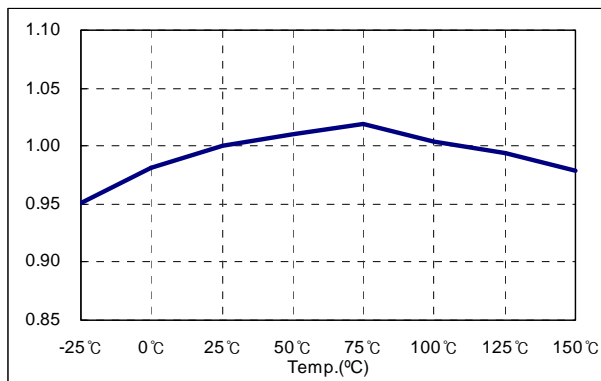

Figure 5. Initial Frequency

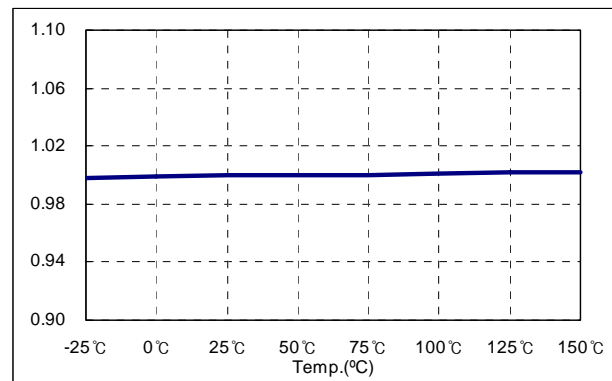

Figure 6. Maximum Duty



Typical Performance Characteristics (Continued)

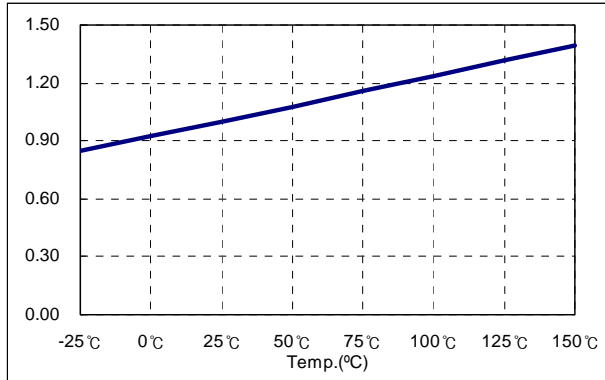

Figure 7. Feedback Offset Voltage

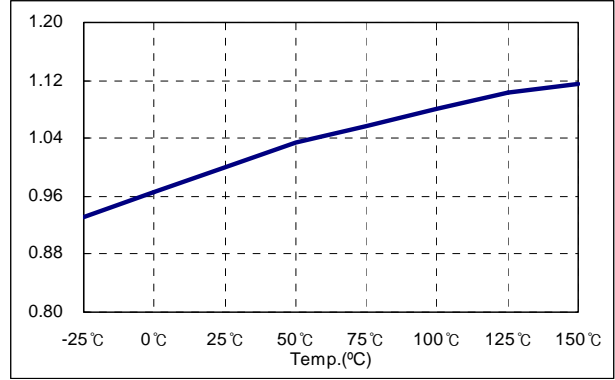

Figure 8. Feedback Source Current

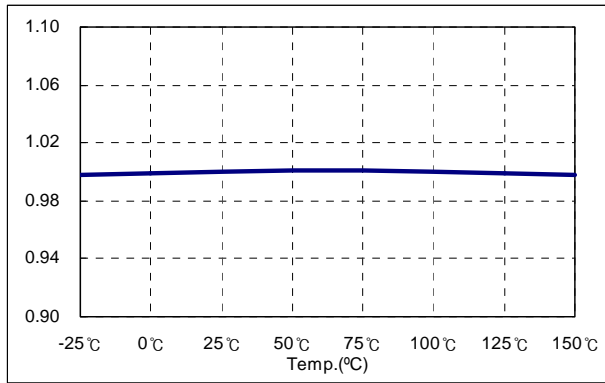

Figure 9. Over Voltage Protection

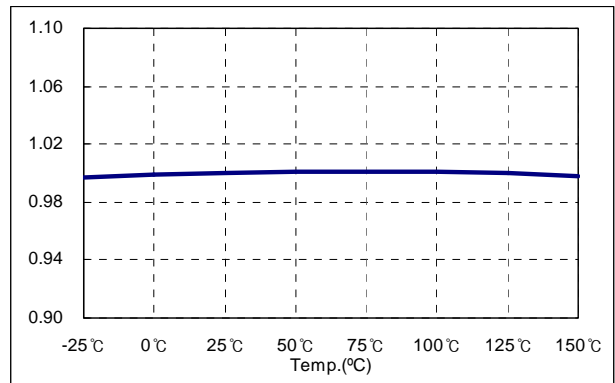

Figure 10. Shutdown Feedback Voltage

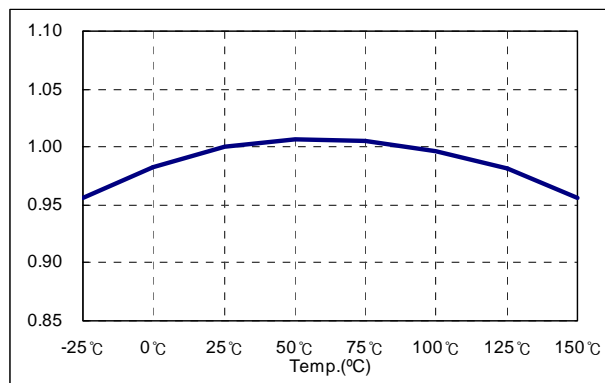

Figure 11. Shutdown Delay Current

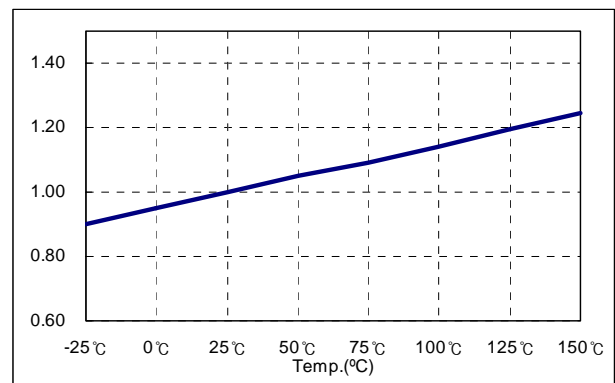

Figure 12. Burst mode Enable Feedback Voltage

Typical Performance Characteristics (Continued)

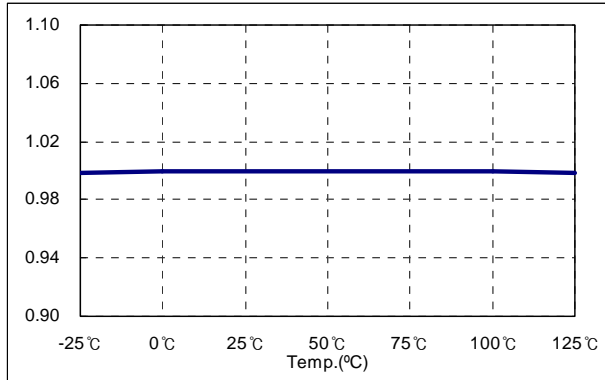

Figure 13. Burst mode Low Threshold Voltage

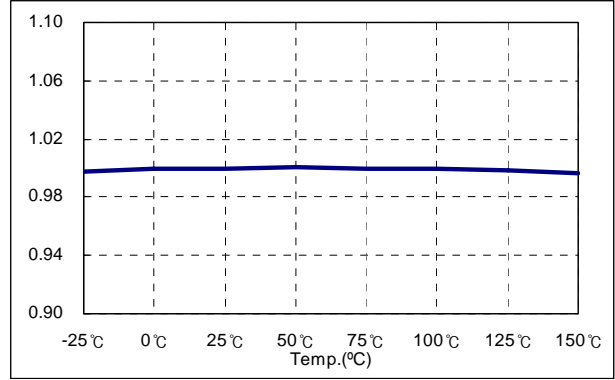

Figure 14. Burst mode High Threshold Voltage

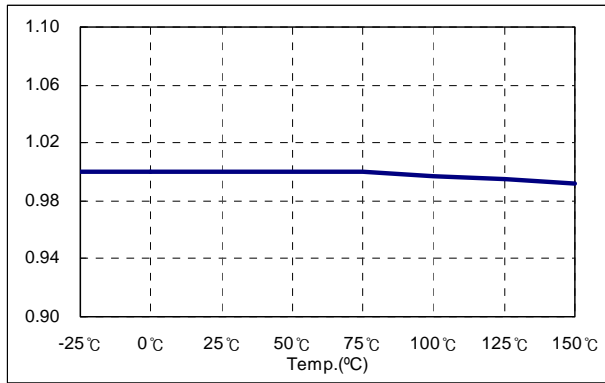

Figure 15. Burst Sync. High Threshold Voltage

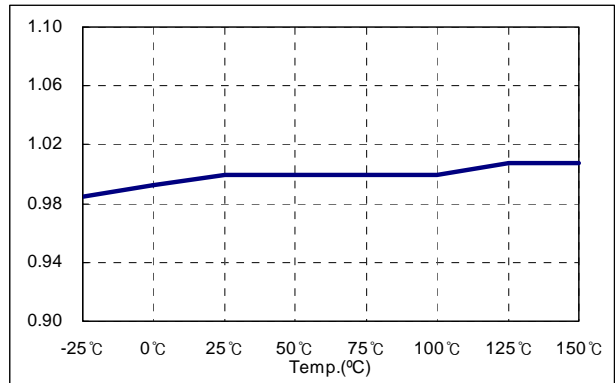

Figure 16. Burst Sync. Low Threshold Voltage

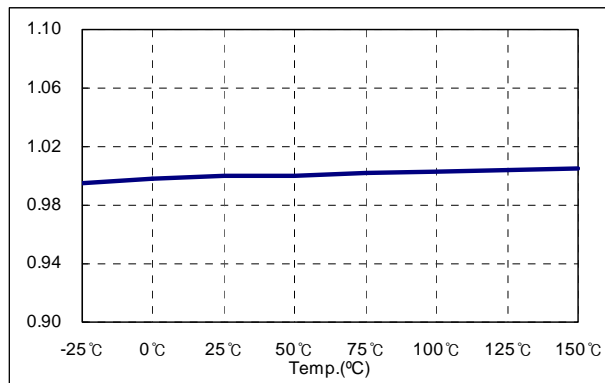

Figure 17. Primary Regulation Threshold Voltage

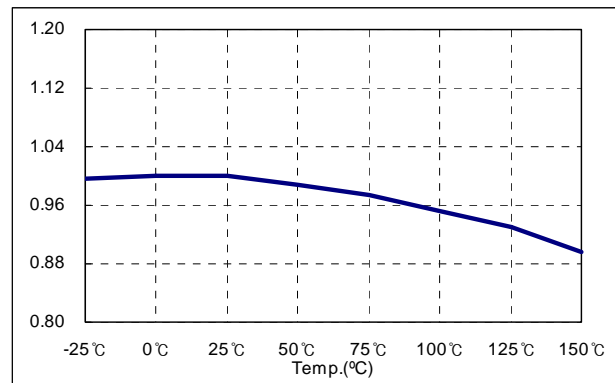

Figure 18. Primary Regulation Transconductance

Typical Performance Characteristics (Continued)

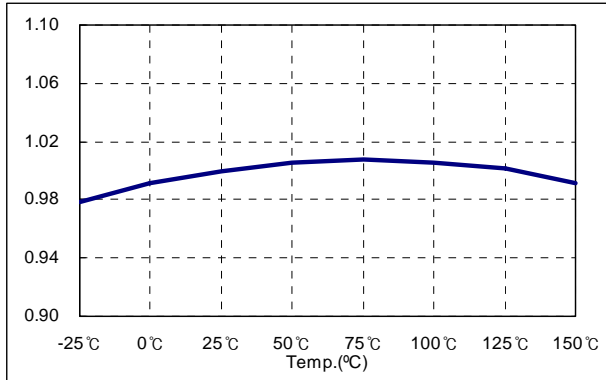

Figure 19. Peak Current Limit

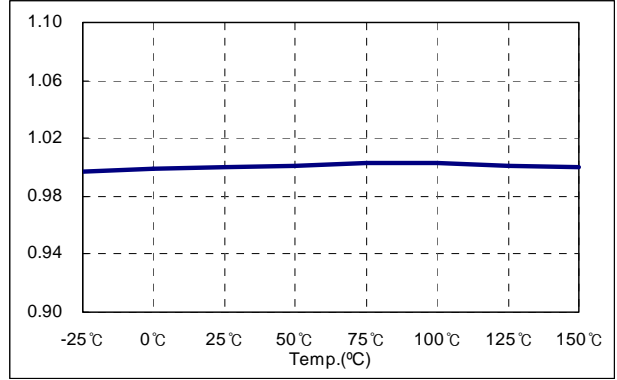

Figure 20. Burst mode Peak Current Limit

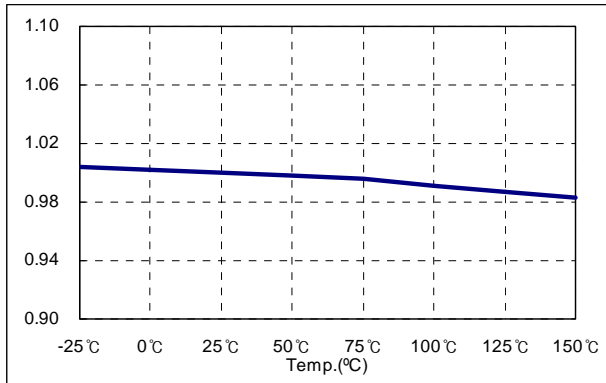

Figure 21. Normal Sync. High Threshold Voltage

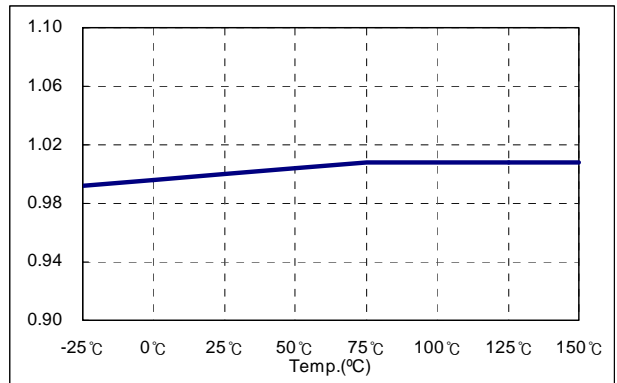
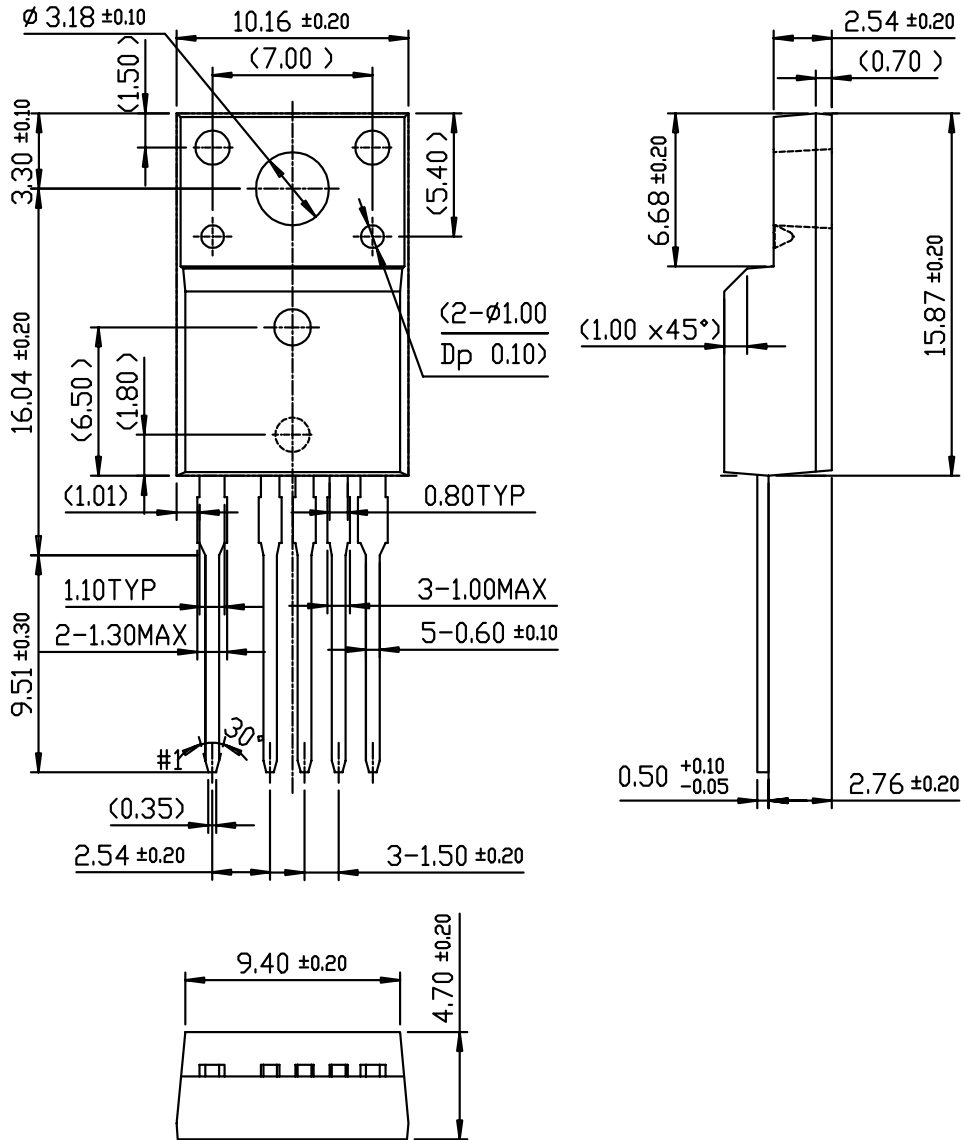

Figure 22. Normal Sync. Low Threshold Voltage

Package Dimensions

TO-220F-5L



## Package Dimensions (Continued)

## TO-220F-5L(Forming)

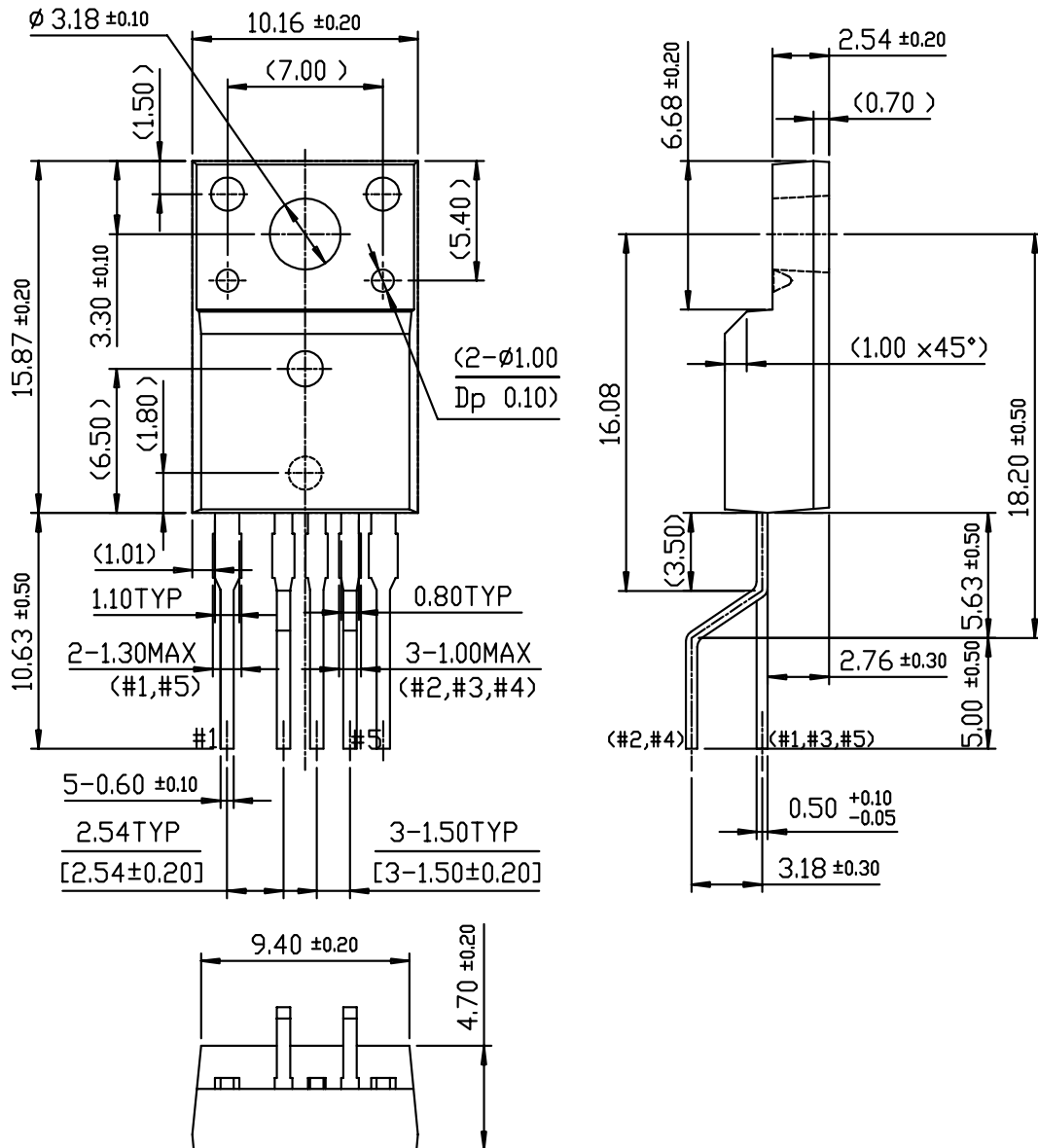

Package Dimensions (Continued)

TO-3PF-5L

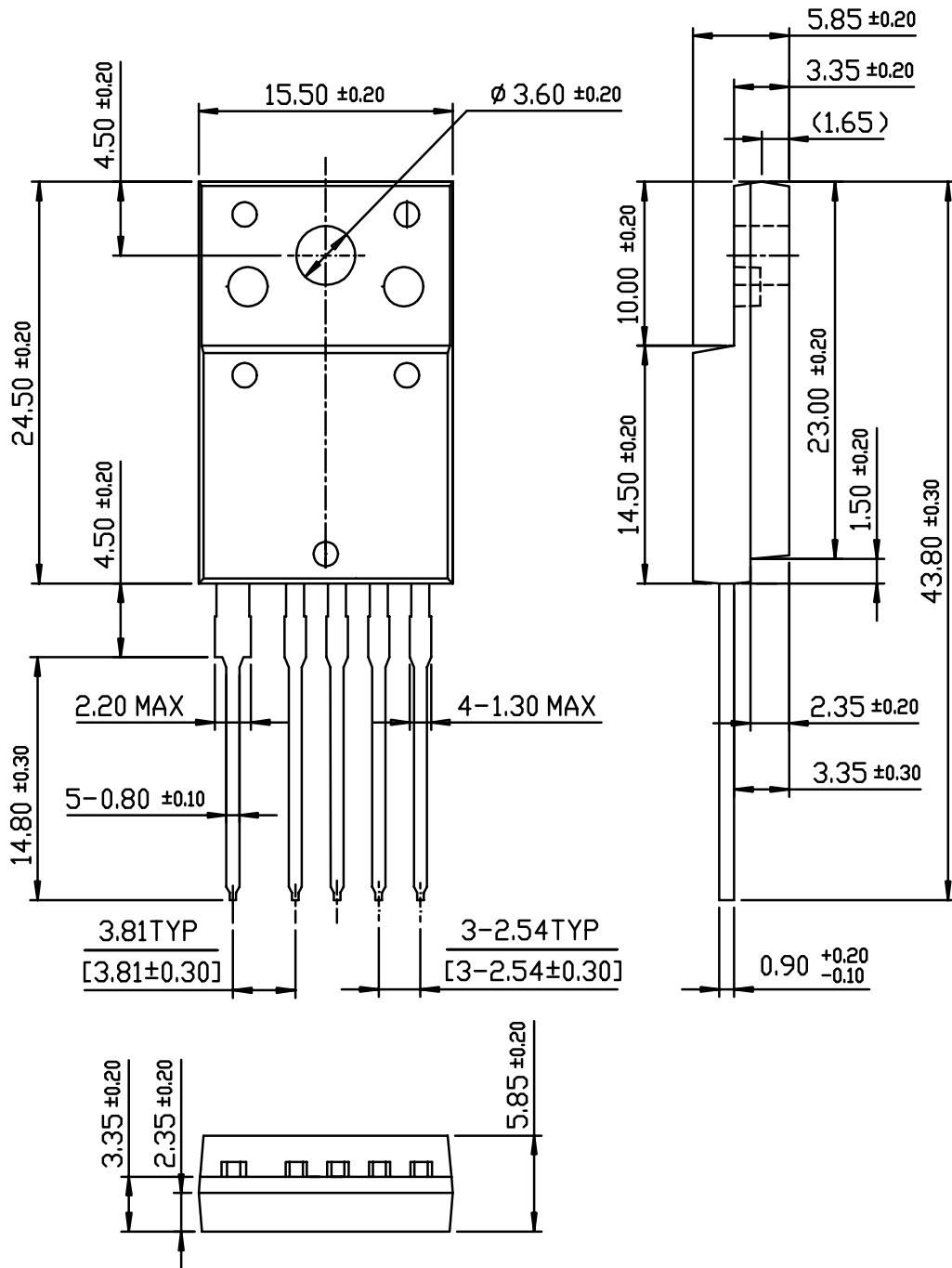

Package Dimensions (Continued)

TO-3PF-5L(Forming)

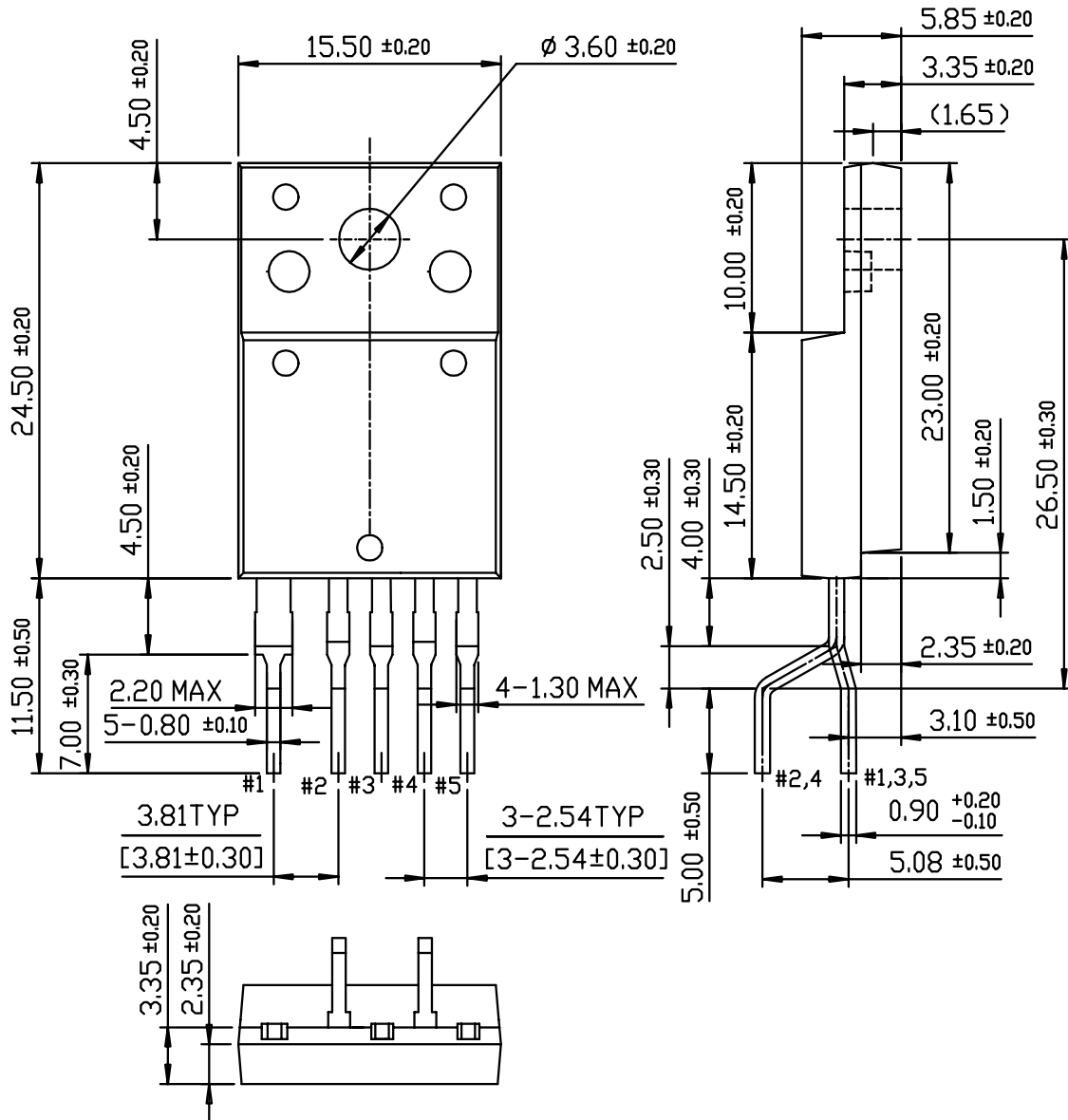

## Ordering Information

Product Number	Package	Rating	IOVER
KA5Q0765RTTU	TO-220F-5L	650V, 7A	5A
KA5Q0765RTYDTU	TO-220F-5L (Forming)		
KA5Q12656RTTU	TO-220F-5L	650V, 12A	6A
KA5Q12656RTYDTU	TO-220F-5L (Forming)		
KA5Q1265RFTU	TO-3PF-5L	650V, 12A	8A
KA5Q1265RFYDTU	TO-3PF-5L (Forming)		
KA5Q1565RFTU	TO-3PF-5L	650V, 15A	11.5A
KA5Q1565RFYDTU	TO-3PF-5L (Forming)		

TU : Non Forming Type

YDTU : Forming Type

### DISCLAIMER

FAIRCHILD SEMICONDUCTOR RESERVES THE RIGHT TO MAKE CHANGES WITHOUT FURTHER NOTICE TO ANY PRODUCTS HEREIN TO IMPROVE RELIABILITY, FUNCTION OR DESIGN. FAIRCHILD DOES NOT ASSUME ANY LIABILITY ARISING OUT OF THE APPLICATION OR USE OF ANY PRODUCT OR CIRCUIT DESCRIBED HEREIN; NEITHER DOES IT CONVEY ANY LICENSE UNDER ITS PATENT RIGHTS, NOR THE RIGHTS OF OTHERS.

### LIFE SUPPORT POLICY

FAIRCHILD'S PRODUCTS ARE NOT AUTHORIZED FOR USE AS CRITICAL COMPONENTS IN LIFE SUPPORT DEVICES OR SYSTEMS WITHOUT THE EXPRESS WRITTEN APPROVAL OF THE PRESIDENT OF FAIRCHILD SEMICONDUCTOR CORPORATION. As used herein:

1. Life support devices or systems are devices or systems which, (a) are intended for surgical implant into the body, or (b) support or sustain life, and (c) whose failure to perform when properly used in accordance with instructions for use provided in the labeling, can be reasonably expected to result in a significant injury of the user.
2. A critical component in any component of a life support device or system whose failure to perform can be reasonably expected to cause the failure of the life support device or system, or to affect its safety or effectiveness.