

Thermally-Enhanced High Power RF LDMOS FET 45 W, 2420 – 2480 MHz

Description

The PTFA240451E is a thermally-enhanced, 45-watt, internally-matched **GOLDMOS**[®] FET intended for CDMA2000 and WiMAX applications from 2420 to 2480 MHz. Thermally-enhanced packaging provides the coolest operation available. Full gold metallization ensures excellent device lifetime and reliability.

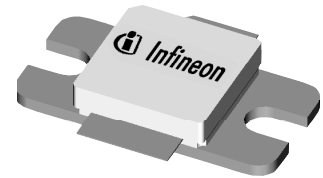

PTFA240451E
Package H-30265-2

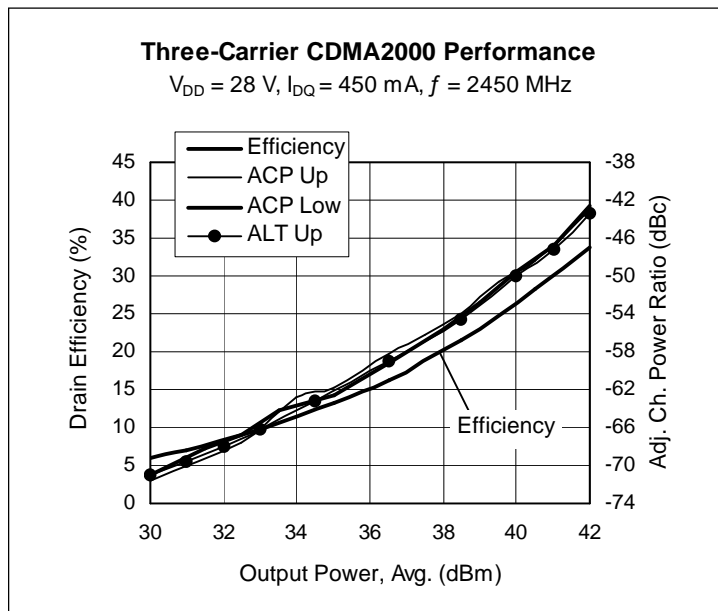

Features

- Thermally-enhanced, lead-free and RoHS-compliant packaging
- Broadband internal matching
- Typical two-carrier CDMA performance at 2450 MHz, 28 V
 - Average output power = 10 W
 - Linear Gain = 14 dB
 - Efficiency = 27%
 - Adjacent channel power = -45 dBc
- Typical CW performance, 2450 MHz, 28 V
 - Output power at P-1dB = 50 W
 - Efficiency = 54%
- Integrated ESD protection: Human Body Model, Class 2 (minimum)
- Excellent thermal stability, low HCI drift
- Capable of handling 10:1 VSWR @ 28 V, 45 W (CW) output power

RF Characteristics

3-Carrier CDMA2000 Measurements (not subject to production test—verified by design/characterization in Infineon test fixture)

$V_{DD} = 28\text{ V}$, $I_{DQ} = 450\text{ mA}$, $P_{OUT} = 14\text{ W}$ average, $f = 2450\text{ MHz}$, channel bandwidth = 3.75 MHz; ACPR measured in 30 kHz bandwidth at $f_C \pm 2.135\text{ MHz}$ offset

Characteristic	Symbol	Min	Typ	Max	Unit
Gain	G_{ps}	—	14	—	dB
Drain Efficiency	η_D	—	31	—	%
Adjacent Channel Power Ratio	ACPR	—	-45	—	dBc

All published data at $T_{CASE} = 25^\circ\text{C}$ unless otherwise indicated

ESD: Electrostatic discharge sensitive device—observe handling precautions!

RF Characteristics (cont.)

Two-tone Measurements (tested in Infineon test fixture)

 $V_{DD} = 28\text{ V}$, $I_{DQ} = 450\text{ mA}$, $P_{OUT} = 45\text{ W PEP}$, $f = 2480\text{ MHz}$, tone spacing = 1 MHz

Characteristic	Symbol	Min	Typ	Max	Unit
Gain	G_{ps}	13.5	14	—	dB
Drain Efficiency	η_D	39	40	—	%
Intermodulation Distortion	IMD	—	-30	-28	dBc

DC Characteristics

Characteristic	Conditions	Symbol	Min	Typ	Max	Unit
Drain-Source Breakdown Voltage	$V_{GS} = 0\text{ V}$, $I_{DS} = 10\text{ mA}$	$V_{(BR)DSS}$	65	—	—	V
Drain Leakage Current	$V_{DS} = 28\text{ V}$, $V_{GS} = 0\text{ V}$	I_{DSS}	—	—	1.0	μA
	$V_{DS} = 63\text{ V}$, $V_{GS} = 0\text{ V}$	I_{DSS}	—	—	10.0	μA
On-State Resistance	$V_{GS} = 10\text{ V}$, $V_{DS} = 0.1\text{ V}$	$R_{DS(on)}$	—	0.17	—	Ω
Operating Gate Voltage	$V_{DS} = 28\text{ V}$, $I_{DQ} = 450\text{ mA}$	V_{GS}	2.0	2.5	3.0	V
Gate Leakage Current	$V_{GS} = 10\text{ V}$, $V_{DS} = 0\text{ V}$	I_{GSS}	—	—	1.0	μA

Maximum Ratings

Parameter	Symbol	Value	Unit
Drain-Source Voltage	V_{DSS}	65	V
Gate-Source Voltage	V_{GS}	-0.5 to +12	V
Junction Temperature	T_J	200	$^{\circ}\text{C}$
Total Device Dissipation	P_D	196	W
		Above 25 $^{\circ}\text{C}$ derate by	1.12
Storage Temperature Range	T_{STG}	-40 to +150	$^{\circ}\text{C}$
Thermal Resistance ($T_{CASE} = 70^{\circ}\text{C}$, 45 W CW)	$R_{\theta JC}$	0.89	$^{\circ}\text{C/W}$

Ordering Information

Type and Version	Package Outline	Package Description	Marking
PTFA240451E V1	H-30265-2	Thermally-enhanced slotted flange, single-ended	PTFA240451E

Typical Performance (data taken in a production test fixture)

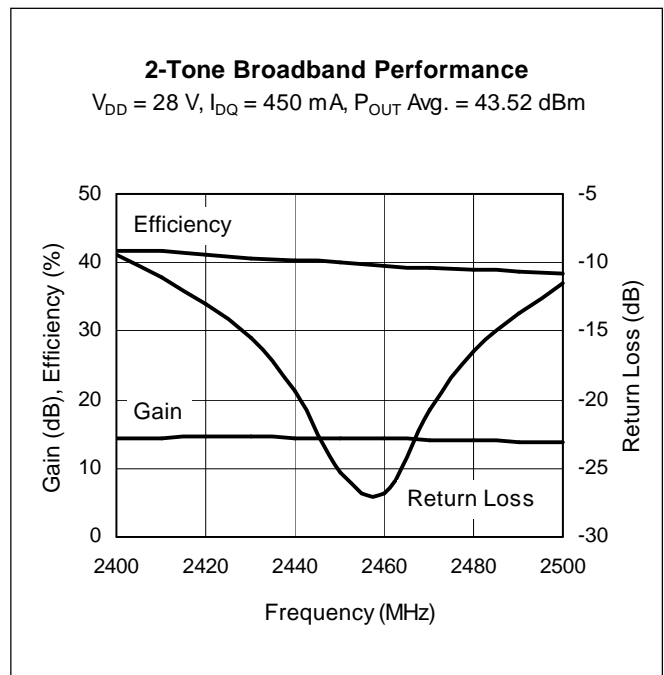
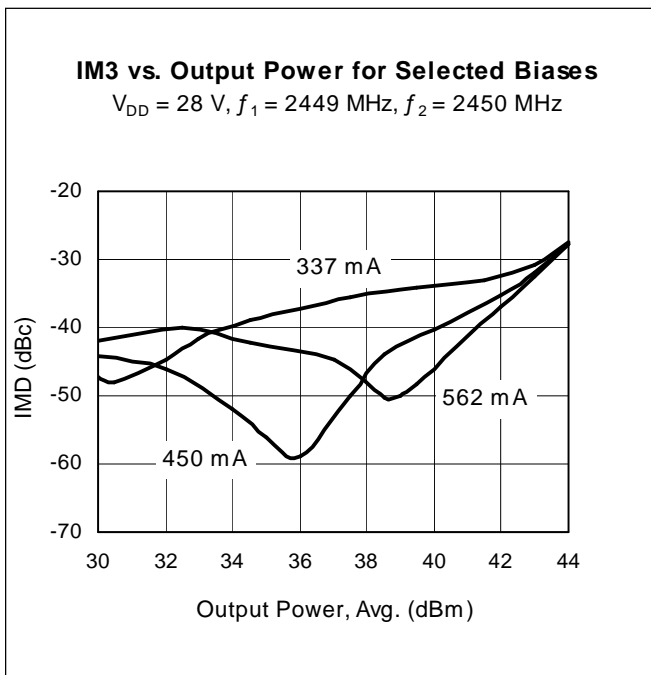
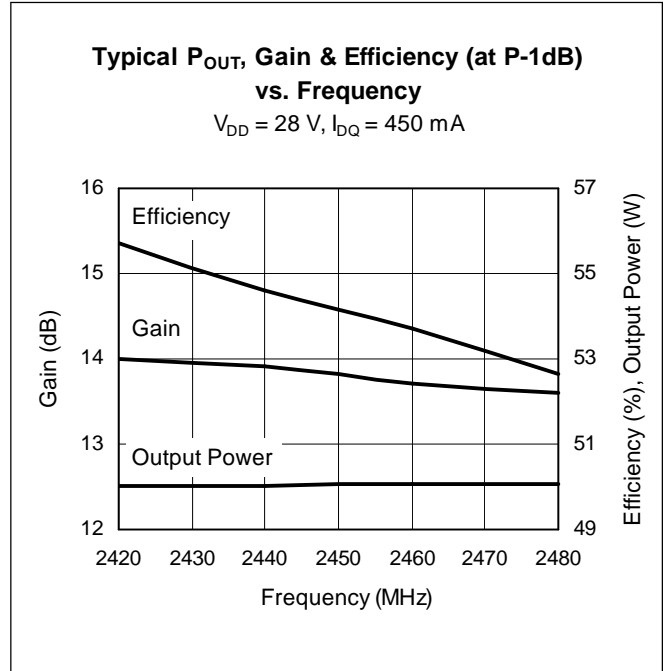
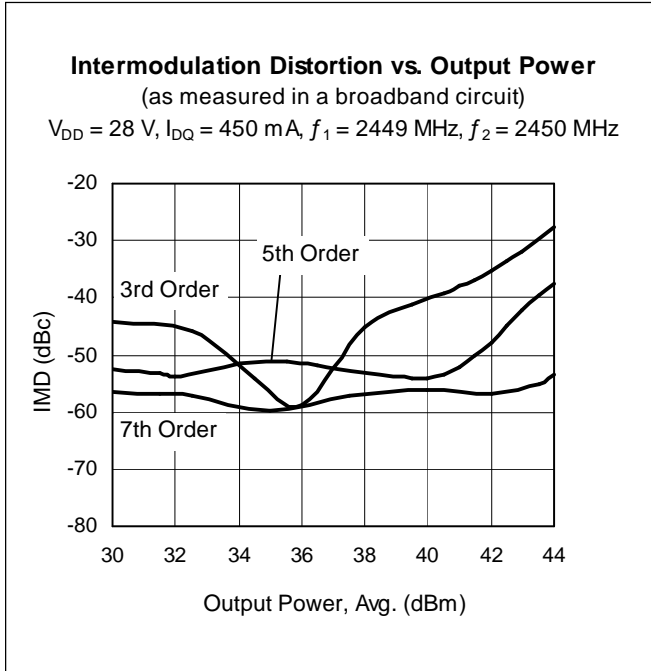

Typical Performance (cont.)

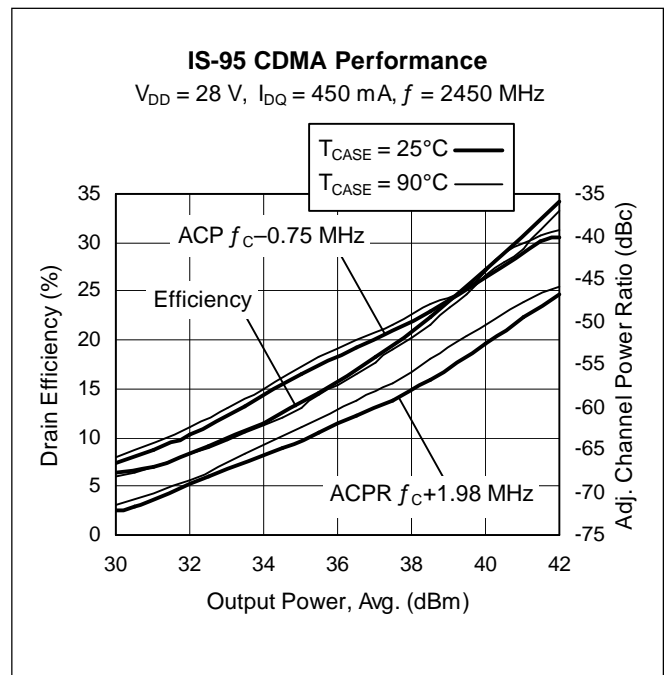
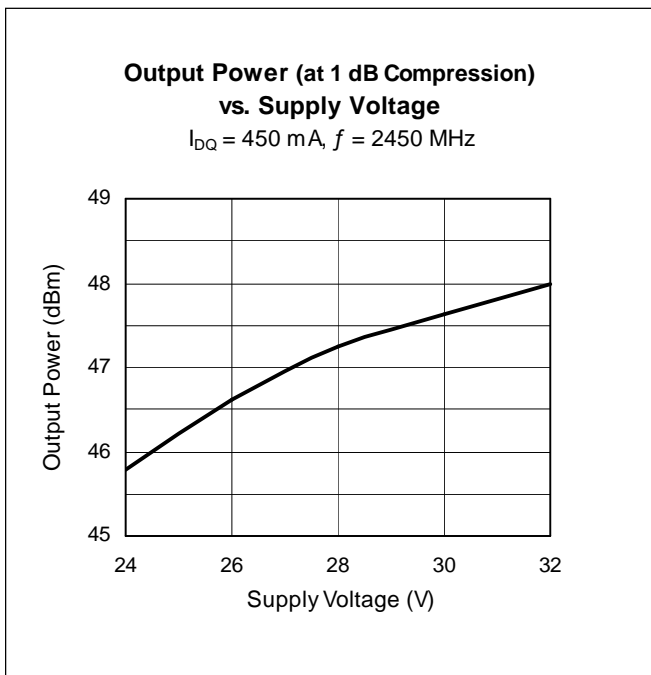
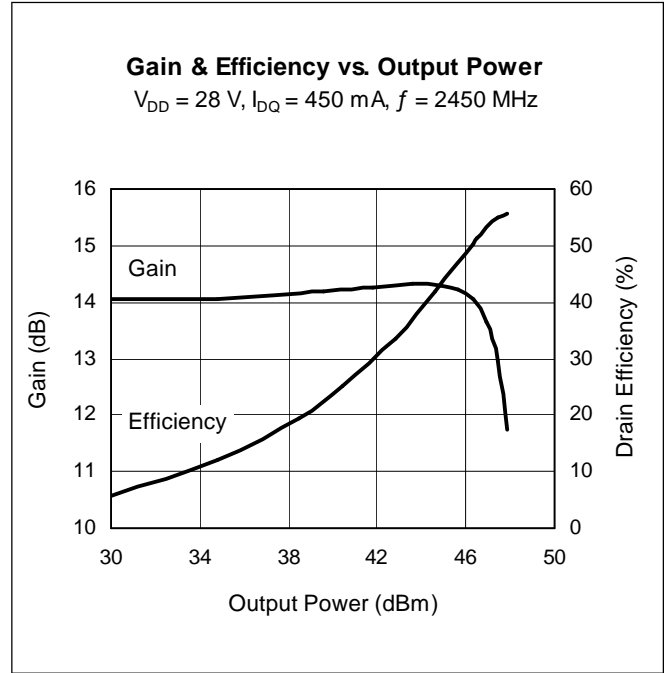
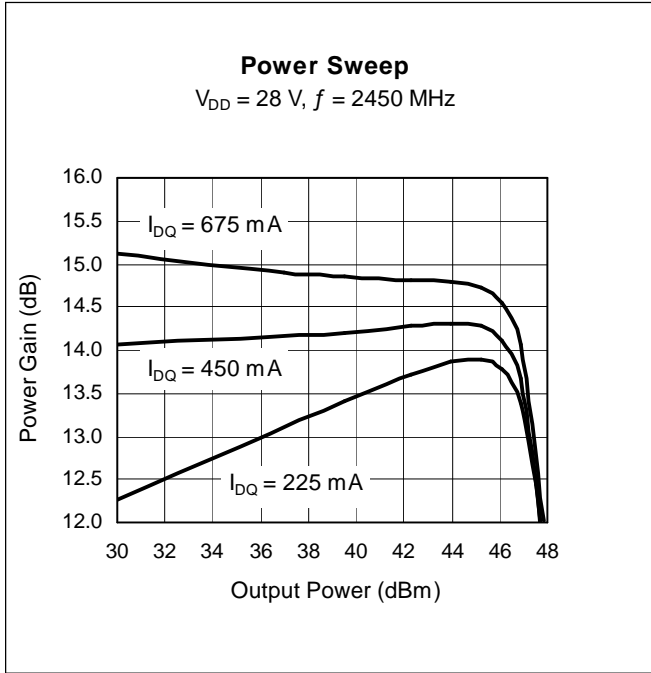

Typical Performance (cont.)

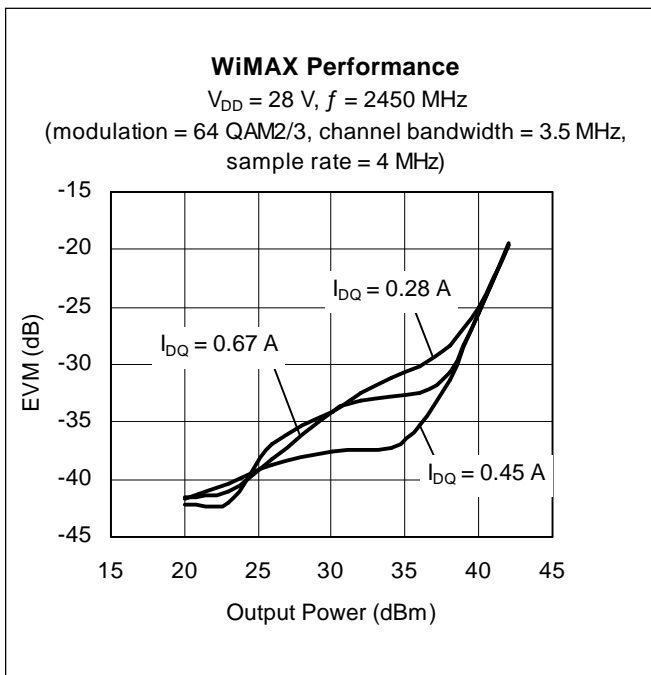
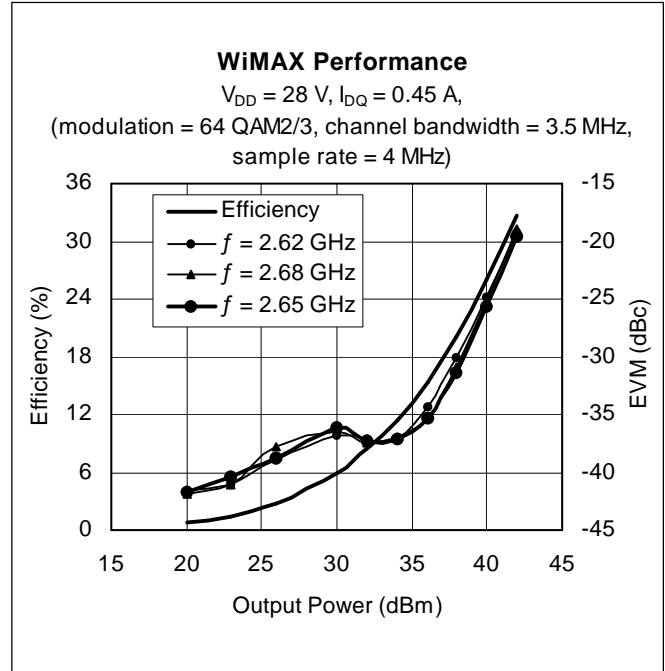
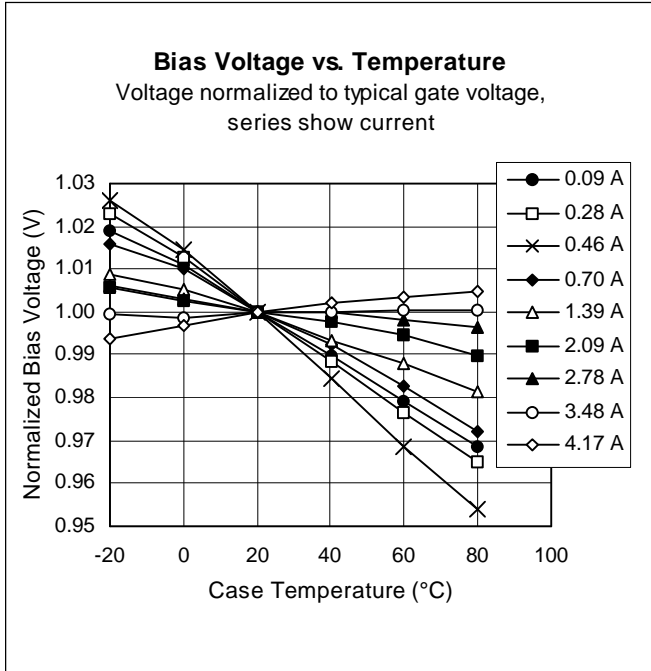

Broadband Circuit Impedance

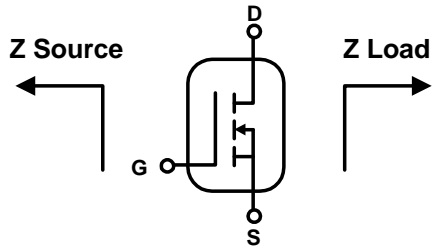

Frequency MHz	Z Source W		Z Load W	
	R	jX	R	jX
2400	22.12	-18.74	6.98	-2.35
2420	20.27	-18.71	6.73	-2.14
2450	18.30	-19.18	6.61	-2.17
2480	15.24	-19.95	6.17	-2.32
2500	13.45	-20.19	5.92	-2.41

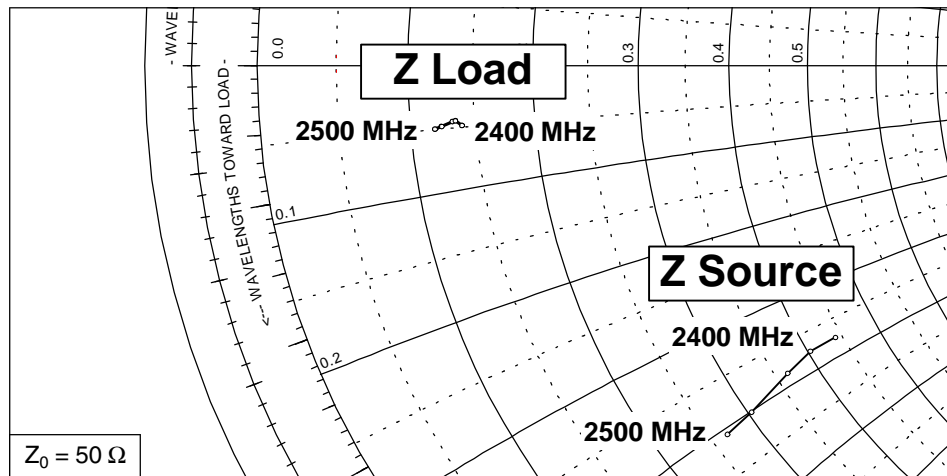

See next page for circuit information

Reference Circuit

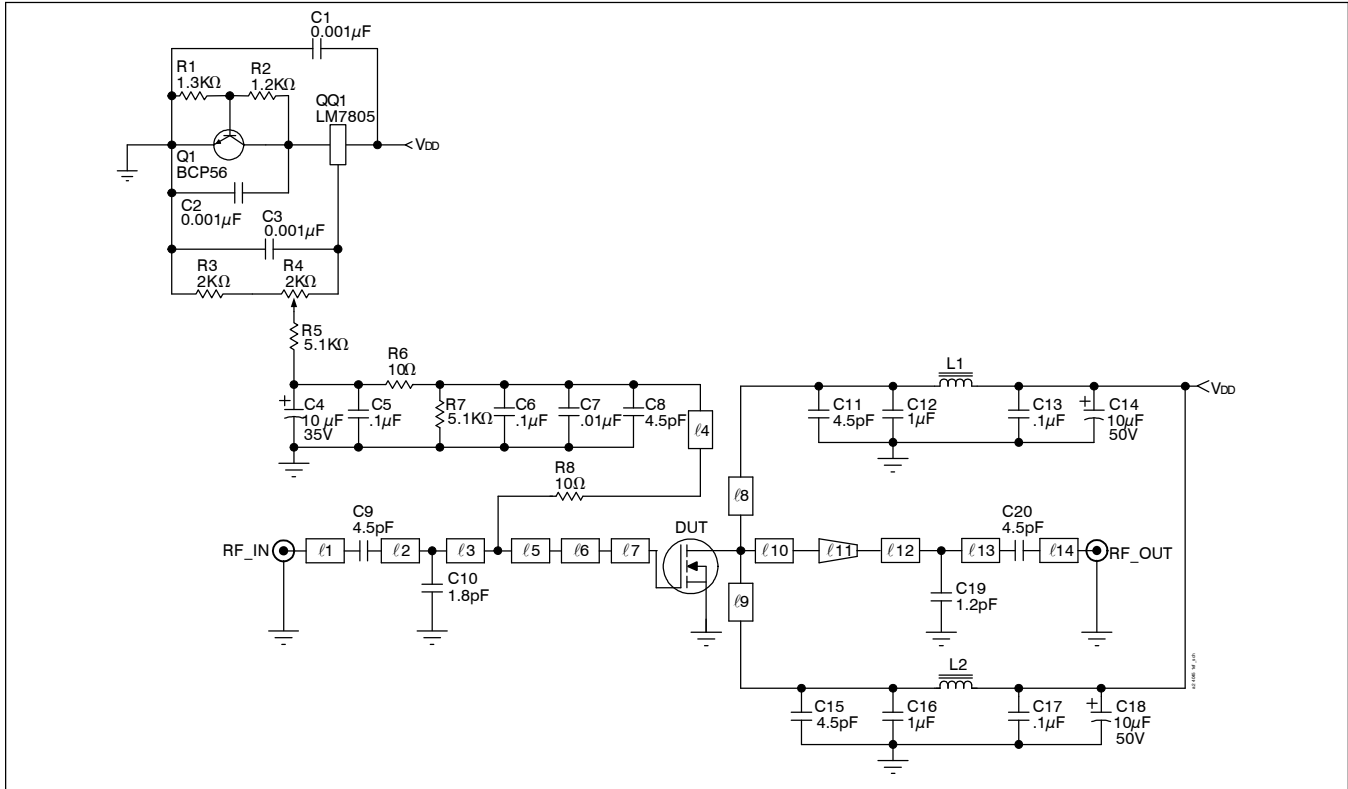

Reference circuit schematic for $f = 2480 \text{ MHz}$

Circuit Assembly Information

DUT	PTFA240451E	LDMOS Transistor	
PCB	0.76 mm [.030"] thick, $\epsilon_r = 4.5$	Rogers TMM4	2 oz. copper

Microstrip	Electrical Characteristics at 2480 MHz ¹	Dimensions: L x W (mm)	Dimensions: L x W (in.)
l_1	0.102λ , 50.0 Ω	6.68 x 1.40	0.263 x 0.055
l_2	0.050λ , 44.0 Ω	3.12 x 1.78	0.123 x 0.070
l_3	0.094λ , 44.0 Ω	6.10 x 1.78	0.240 x 0.070
l_4	0.148λ , 64.0 Ω	9.86 x 0.89	0.388 x 0.035
l_5	0.016λ , 44.0 Ω	1.04 x 1.78	0.041 x 0.070
l_6	0.021λ , 14.7 Ω	1.35 x 7.62	0.053 x 0.300
l_7	0.080λ , 8.2 Ω	4.78 x 14.86	0.188 x 0.585
l_8, l_9	0.295λ , 50.0 Ω	19.30 x 1.40	0.760 x 0.055
l_{10}	0.049λ , 6.5 Ω	2.84 x 19.05	0.112 x 0.750
l_{11} (taper)	0.079λ , 6.5 Ω / 50.0 Ω	5.16 x 19.05 / 1.40	0.203 x 0.750 / 0.055
l_{12}	0.045λ , 50.0 Ω	2.95 x 1.40	0.116 x 0.055
l_{13}	0.117λ , 50.0 Ω	7.62 x 1.40	0.300 x 0.055
l_{14}	0.058λ , 50.0 Ω	3.81 x 1.40	0.150 x 0.055

¹Electrical characteristics are rounded.

Reference Circuit (cont.)

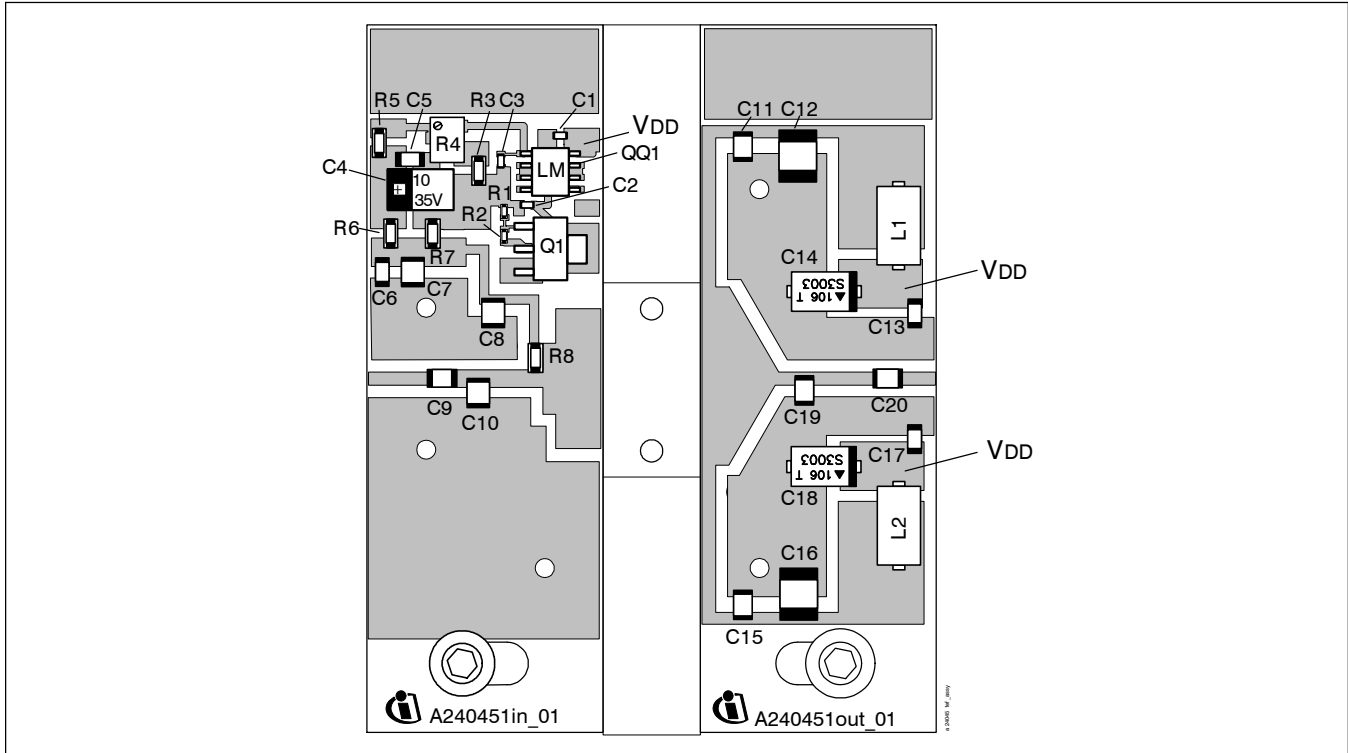

Reference circuit assembly diagram* (not to scale)

Component	Description	Suggested Manufacturer	P/N or Comment
C1, C2, C3	Capacitor, 0.001 μ F	Digi-Key	PCC1772CT-ND
C4	Tantalum capacitor, 10 μ F, 35 V	Digi-Key	PCS6106TR-ND
C5, C6, C13, C17	Capacitor, 0.1 μ F	Digi-Key	PCC104BCT-ND
C7	Ceramic capacitor, 0.01 μ F	ATC	200B 103
C8, C9, C11, C15, C20	Ceramic capacitor, 4.5 pF	ATC	100B 4R5
C10	Ceramic capacitor, 1.8 pF	ATC	100B 1R8
C12, C16	Capacitor, 1 μ F	ATC	920C105KW
C14, C18	Tantalum capacitor, 10 μ F, 50 V	Garrett Electronics	TPSE106K050R0400
C19	Ceramic capacitor, 1.2 pF	ATC	100B 1R2
L1, L2	Ferrite	Philips	BDS46/3.8.8-452
Q1	Transistor	Infineon	BCP56
QQ1	Voltage regulator	National Semiconductor	LM7805
R1	Chip resistor, 1.3 k-ohms	Digi-Key	P1.3KGCT-ND
R2	Chip resistor, 1.2 k-ohms	Digi-Key	P1.2KGCT-ND
R3	Chip resistor, 2 k-ohms	Digi-Key	P2.0KECT-ND
R4	Potentiometer, 2 k-ohms	Digi-Key	3224W-202ETR-ND
R5, R7	Chip resistor, 5.1 k-ohms	Digi-Key	P5.1KECT-ND
R6, R8	Chip resistor, 10 ohms	Digi-Key	P10ECT-ND

*Gerber Files for this circuit available on request

Package Outline Specifications

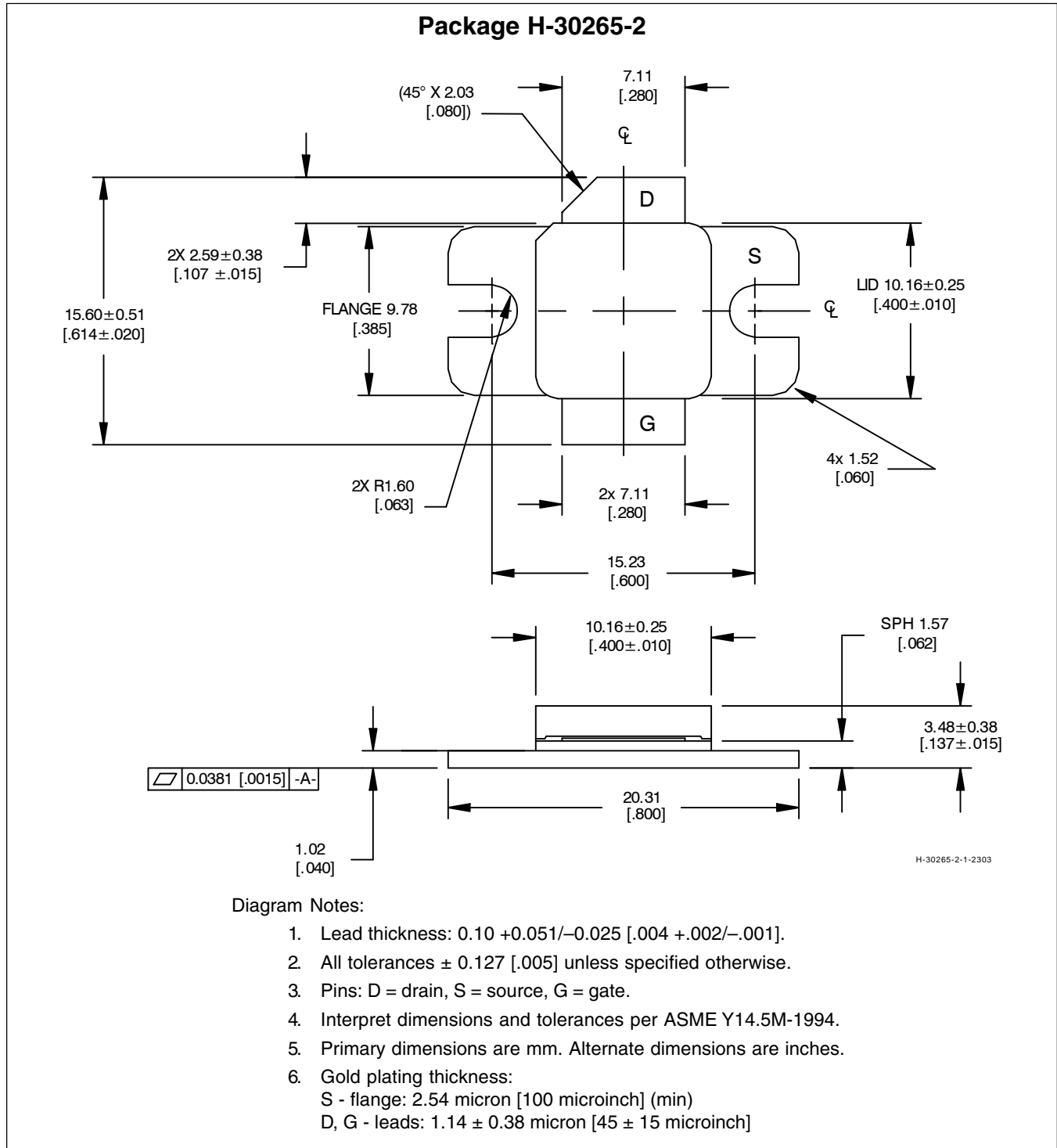

Find the latest and most complete information about products and packaging at the Infineon Internet page <http://www.infineon.com/rfpower>

Page	Subjects (major changes since last revision)
All	Remove references to alternate products.

We Listen to Your Comments

Any information within this document that you feel is wrong, unclear or missing at all?

Your feedback will help us to continuously improve the quality of this document.

Please send your proposal (including a reference to this document) to:

highpowerRF@infineon.com

To request other information, contact us at:
+1 877 465 3667 (1-877-GO-LDMOS) USA
or +1 408 776 0600 International

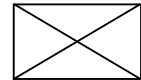

GOLDMOS[®] is a registered trademark of Infineon Technologies AG.

Edition 2008-03-04

Published by

Infineon Technologies AG
81726 München, Germany

© Infineon Technologies AG 2005.

All Rights Reserved.

Legal Disclaimer

The information given in this document shall in no event be regarded as a guarantee of conditions or characteristics ("Beschaffenheitsgarantie"). With respect to any examples or hints given herein, any typical values stated herein and/or any information regarding the application of the device, Infineon Technologies hereby disclaims any and all warranties and liabilities of any kind, including without limitation warranties of non-infringement of intellectual property rights of any third party.

Information

For further information on technology, delivery terms and conditions and prices please contact your nearest Infineon Technologies Office (www.infineon.com/rfpower).

Warnings

Due to technical requirements components may contain dangerous substances. For information on the types in question please contact your nearest Infineon Technologies Office.

Infineon Technologies Components may only be used in life-support devices or systems with the express written approval of Infineon Technologies, if a failure of such components can reasonably be expected to cause the failure of that life-support device or system, or to affect the safety or effectiveness of that device or system. Life support devices or systems are intended to be implanted in the human body, or to support and/or maintain and sustain and/or protect human life. If they fail, it is reasonable to assume that the health of the user or other persons may be endangered.