

Single-chip Type with Built-in FET Switching Regulators

High-efficiency Step-up Switching Regulator with Built-in Power MOSFET



BD8311NUV

No.10027ECT03

●Description

ROHM's High-efficiency Step-up Switching Regulator Built-in Power MOSFET BD8311NUV generates step-up output including 8 V or 10 V from 4 batteries, batteries such as Li2cell etc. or a 5 V fixed power supply line.

This IC allows easy production of small and a wide range of output current, and is equipped with an external coil/capacitor downsized by high frequency operation of 1.2 MHz, built-in 2.5 A rated 80 mΩ Nch FET SW, and flexible phase compensation system on board.

●Features

- 1) Incorporates Nch FET capable of withstanding 2.5 A/14 V.
- 2) Incorporates phase compensation device between input and output of ERROR AMP.
- 3) Small coils and capacitors to be used by high frequency operation of 1.2 MHz
- 4) Input voltage 3.5 V – 11 V
- 5) Output current 600 mA (3.5 V – 10 V) at 10 V
800 mA (3.5 V – 8 V) at 8 V
- 6) Incorporates soft-start function.
- 7) Incorporates timer latch system short protecting function.
- 8) As small as 3 mm², SON 10-pin package VSON010V3030

●Application

General portable equipment like DSC/DVC powered by 4 dry batteries or Li2cell

●Absolute Maximum Ratings

Parameter	Symbol	Ratings	Unit
Maximum applied power voltage	VCC, LX	14	V
Maximum input voltage	SWOUT, INV	14	V
Maximum input current	linmax	2.5	A
Power dissipation	Pd	700	mW
Operating temperature range	Topr	-25 to +85	°C
Storage temperature range	Tstg	-55 to +150	°C
Junction temperature	Tjmax	+150	°C

*1 When used at Ta = 25°C or more installed on a 74.2 × 74.2 × 1.6t mm board, the rating is reduced by 5.6 mW/°C.

* These specifications are subject to change without advance notice for modifications and other reasons.

●Operating Conditions (Ta = 25°C)

Parameter	Symbol	Ratings	Unit
Power supply voltage	VCC	3.5 to 11	V
Output voltage	VOUT	4.0 to 11	V

●Electrical characteristics

Parameter	Symbol	Limits			Unit	Conditions
		Min.	Typ.	Max.		
[Low voltage input malfunction preventing circuit]						
Detection threshold voltage	Vuv	-	2.9	3.2	V	VREG monitor
Hysteresis range	ΔV_{uvhy}	100	200	300	mV	
[Oscillator]						
Oscillation frequency	fosc	1.1	1.2	1.3	MHz	
[Regulator]						
Output voltage	VREG	4.65	5.0	5.35	V	
[ERROR AMP]						
INV threshold voltage	VINV	0.99	1.00	1.01	V	
Input bias current	IINV	-50	0	50	nA	VCC=11.0V, VINV=5.5V
Soft-start time	Tss	5.3	8.8	12.2	msec	
[PWM comparator]						
LX Max Duty	Dmax1	77	85	93	%	
[SWOUT]						
ON resistance	RONSWOUT	-	50	100	Ω	
[Output]						
LX NMOS ON resistance	RON	-	80	150	m Ω	
LX leak current	Ileak	-1	0	1	μ A	
[STB]						
STB pin control voltage	Operation	VSTBH	2.5	-	VCC	V
	No-operation	VSTBL	-0.3	-	0.3	V
STB pin pull-down resistance	RSTB	250	400	700	k Ω	
[Circuit current]						
Standby current VCC	ISTB	-	-	1	μ A	
Circuit current at operation VCC	Icc	-	600	900	μ A	VINV=1.2V

Ⓞ Not designed to be resistant to radiation

●Description of Pins

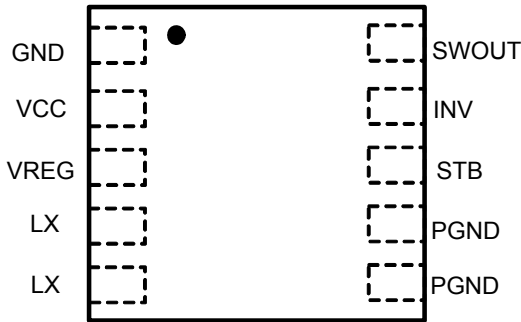

Pin No.	Pin Name	Function
1	GND	Ground terminal
2	VCC	Control part power input terminal
3	VREG	5 V output terminal of regulator for internal circuit
4~5	Lx	Coil connecting terminal
6~7	PGND	Power transistor ground terminal
8	STB	ON/OFF terminal
9	INV	ERROR AMP input terminal
10	SWOUT	STBSW for split resistance

Fig.1 Pin layout

●Block Diagram

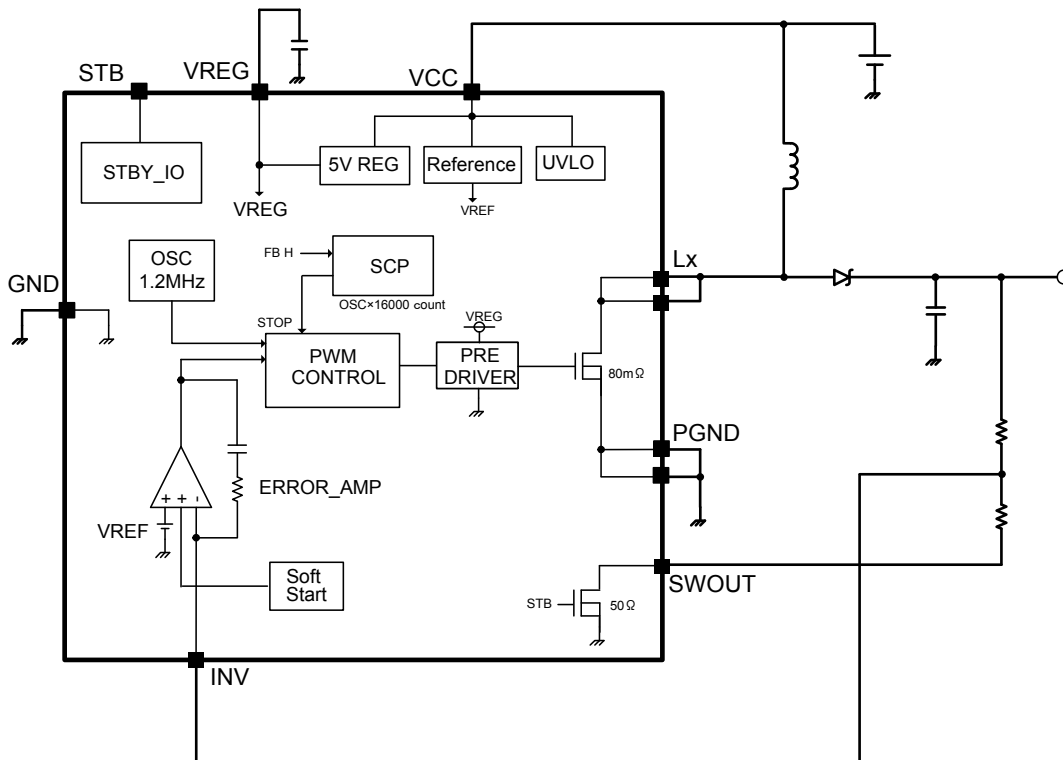

Fig.2 Block diagram

●Description of Blocks

1. VREF
This block generates ERROR AMP reference voltage.
The reference voltage is 1.0 V.
2. UVLO
Circuit for preventing low voltage malfunction
Prevents malfunction of the internal circuit at activation of the power supply voltage or at low power supply voltage.
Monitors VCC pin voltage to turn off all output FET and DC/DC converter output when VCC voltage is lower than 2.9 V, and reset the timer latch of the internal SCP circuit and soft-start circuit. This threshold contains 200 mV hysteresis.
3. SCP
Timer latch system short-circuit protection circuit
When the INV pin is the set 1.0 V or lower voltage, the internal SCP circuit starts counting.
The internal counter is in synch with OSC; the latch circuit activates after a lapse of 13.3 msec after the counter counts about 16000 oscillations and then, turn off DC/DC converter output.
To reset the latch circuit, turn off the STB pin once. Then, turn it on again or turn on the power supply voltage again.
4. OSC
Circuit for oscillating sawtooth waves with an operation frequency fixed at 1.2 MHz
5. ERROR AMP
Error amplifier for detecting output signals and outputting PWM control signals
The internal reference voltage is set at 1.0 V.
A primary phase compensation device of 200 pF, 62 kΩ is built in between the inverting input terminal and the output terminal of this ERROR AMP.
6. PWM COMP
Voltage-pulse width converter for controlling output voltage corresponding to input voltage
Comparing the internal SLOPE waveform with the ERROR AMP output voltage, PWM COMP controls the pulse width to the output to the driver.
Max Duty is set at 85%.
7. SOFT START
Circuit for preventing in-rush current at startup by bringing the output voltage of the DC/DC converter into a soft-start
Soft-start time is in synch with the internal OSC, and the output voltage of the DC/DC converter reaches the set voltage after about 10000 oscillations .
8. PRE DRIVER
CMOS inverter circuit for driving the built-in Nch FET.
9. STBY_IO
Voltage applied on STB pin (8 pin) to control ON/OFF of IC
Turned ON when a voltage of 2.5 V or higher is applied and turned OFF when the terminal is open or 0 V is applied.
Incorporates approximately 400 kΩ pull-down resistance.
10. Nch FET SW
Built-in SW for switching the coil current of the DC/DC converter. Incorporates an 80 mΩ NchFET SW capable of withstanding 14 V.
Since the current rating of this FET is 2.5 A, it should be used within 2.5 A including the DC current and ripple current of the coil.

●Reference Data

(Unless otherwise specified, Ta = 25°C, VCC = 7.4 V)

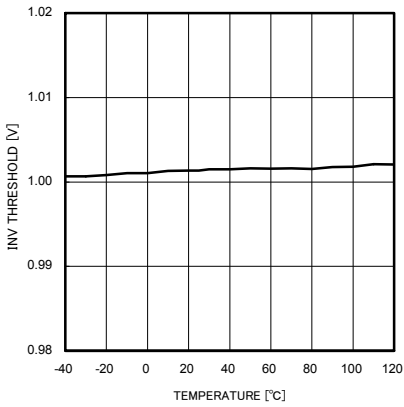

Fig.3. INV threshold temperature property

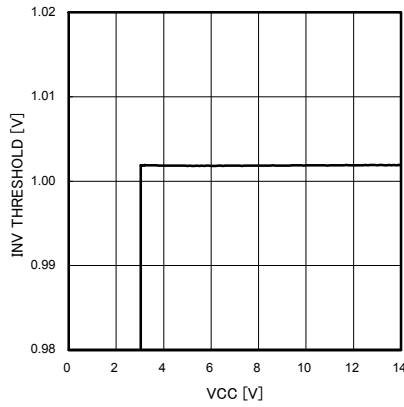

Fig.4. INV threshold power supply property

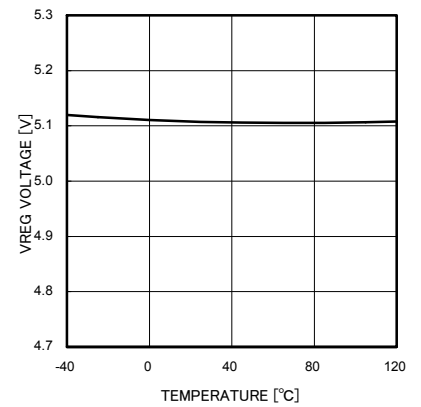

Fig.5. VREG output temperature property

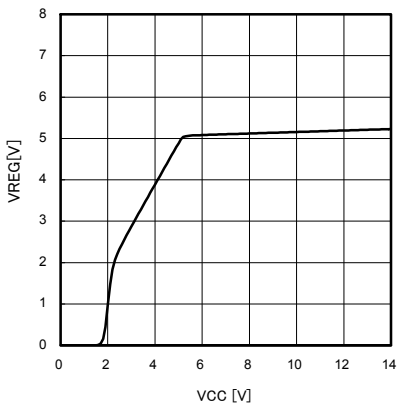

Fig.6. VREG output power supply property

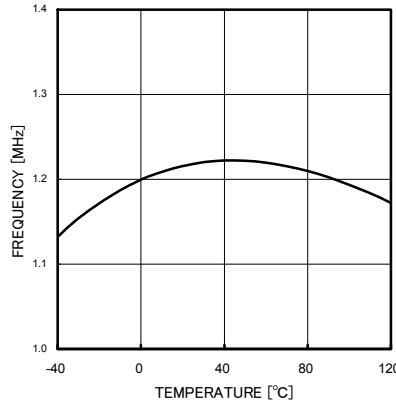

Fig.7. fosc temperature property

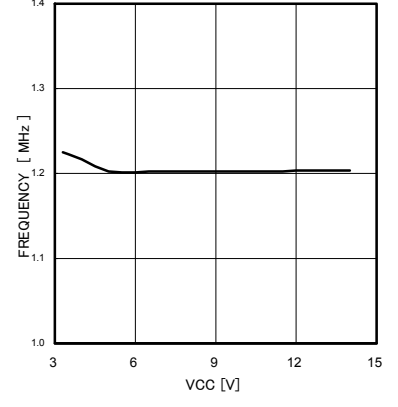

Fig.8. fosc voltage property

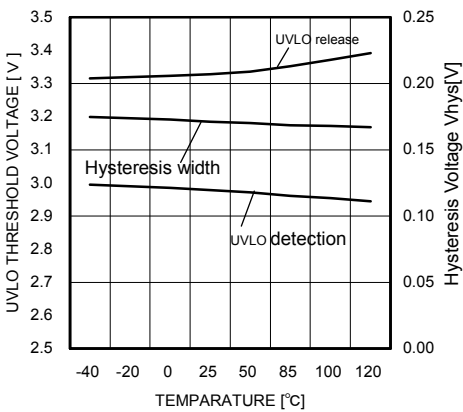

Fig.9. UVLO threshold temperature property

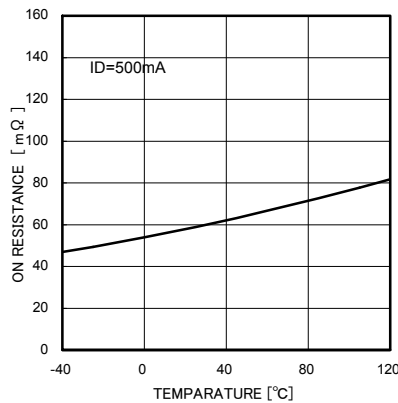

Fig.10. Nch FET ON resistance temperature property

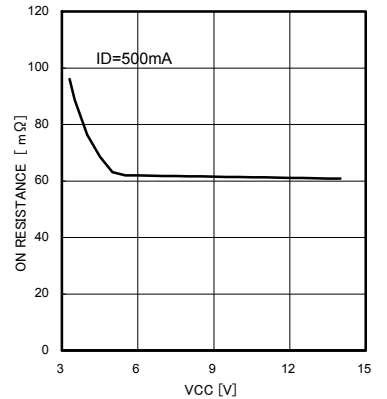

Fig.11. Nch FET ON resistance power supply property

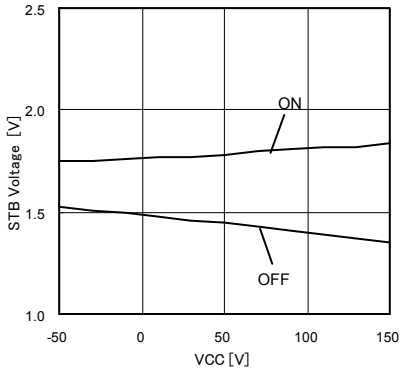

Fig.12. STB threshold temperature

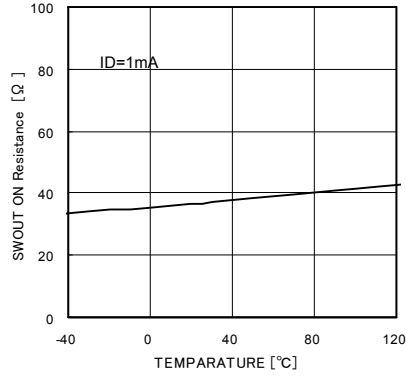

Fig.13. SWOUT ON resistance temperature property

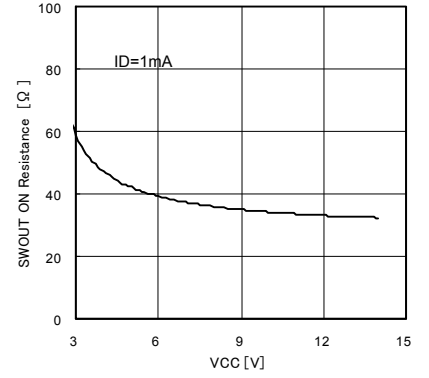

Fig.14. SWOUT ON resistance power supply property

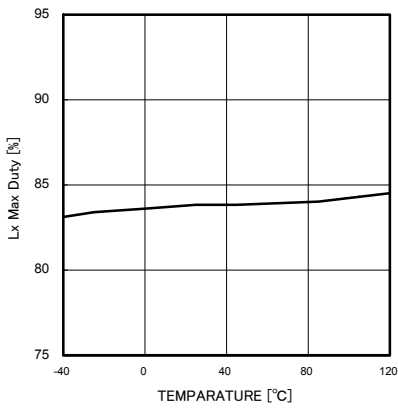

Fig.15. Lx Max duty temperature property

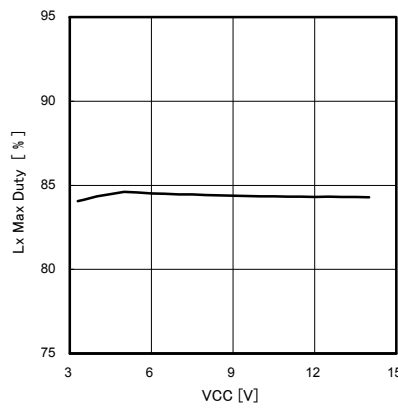

Fig.16. Lx Max duty power supply property

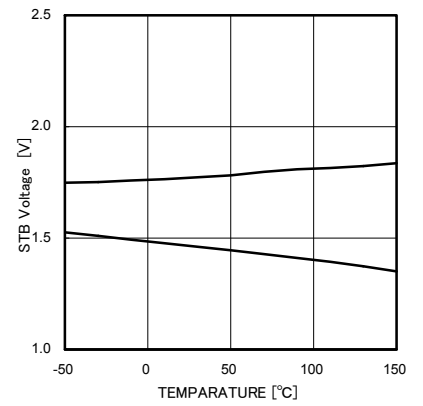

Fig.17. Circuit current temperature property

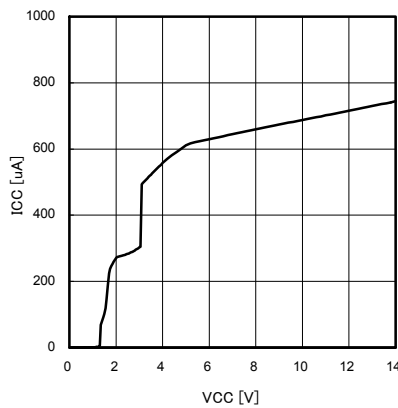

Fig.18. Circuit current power supply property

● Example of Application Input: 3.5 to 10 V, output: 10.1 V / 500 mA

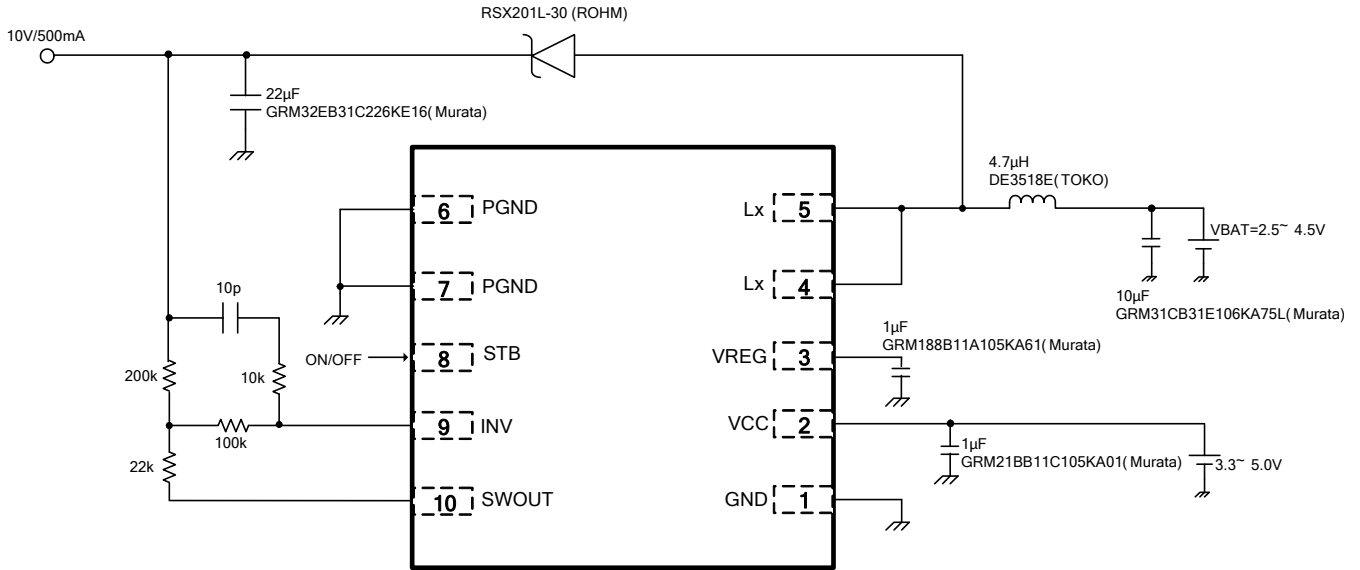

Fig.19 Reference application diagram

● Reference Application Data 1

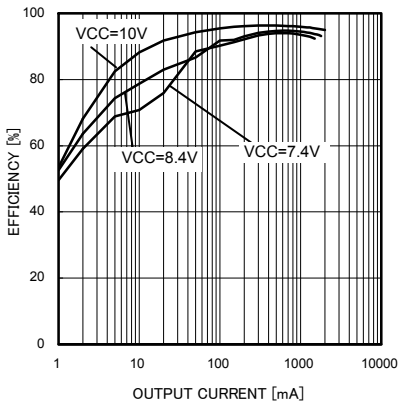

Fig.20 Power conversion efficiency 1

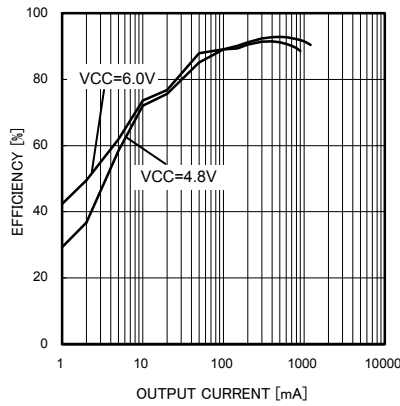

Fig.21 Power conversion efficiency 2

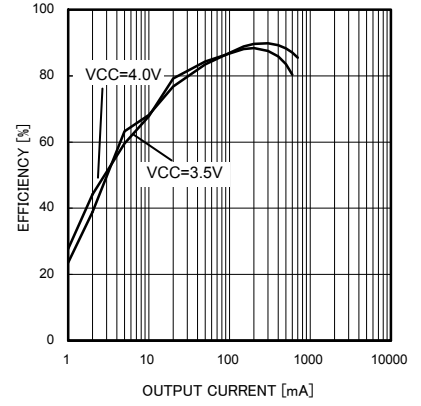

Fig.22 Power conversion efficiency 3

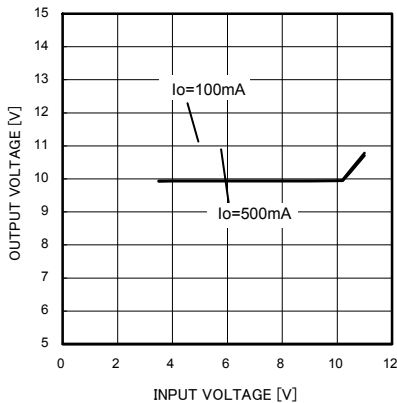

Fig.23 Line regulation

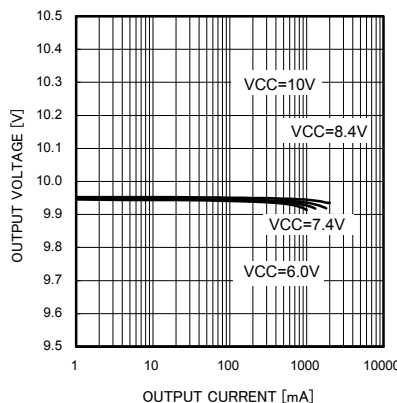

Fig.24 Load regulation 1

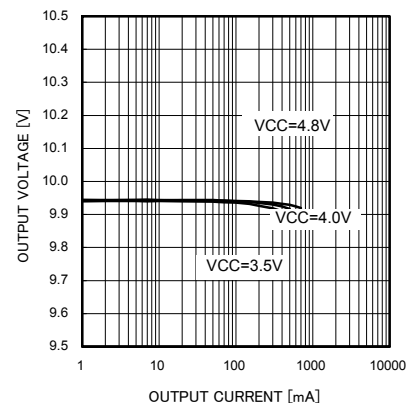

Fig.25 Load regulation 2

● Reference Application Data 2 (VCC = 3.5 V, 6.0 V, 8.4 V, VOUT = 10 V)

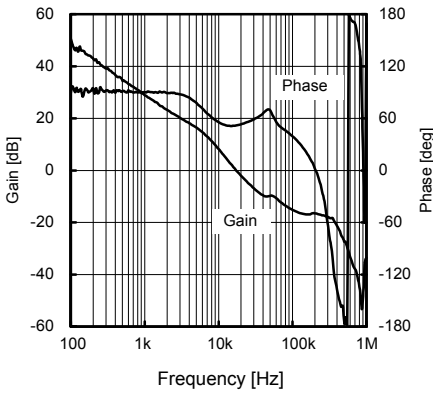

Fig.26 Frequency response property 1 (VCC = 3.5 V, Io = 200 mA)

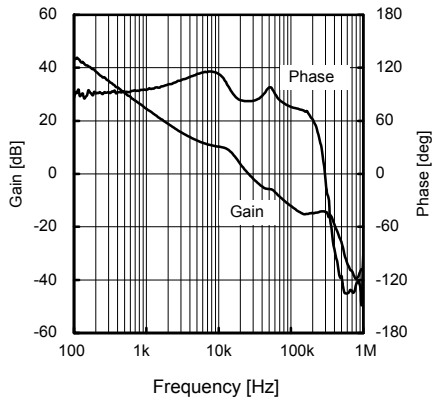

Fig.27 Frequency response property 2 (VCC = 6.0 V, Io = 200 mA)

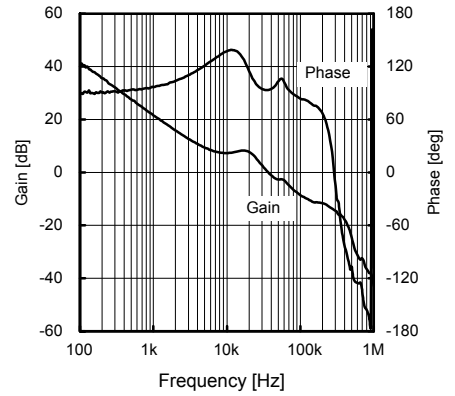

Fig.28 Frequency response property 3 (VCC = 8.4 V, Io = 200 mA)

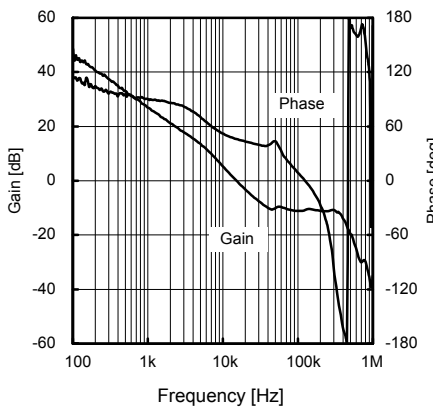

Fig.29 Frequency response property 4 (VCC = 3.5 V, Io = 500 mA)

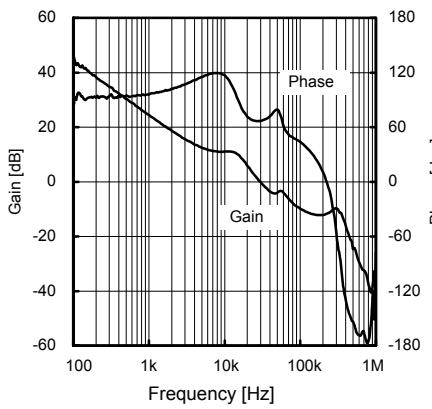

Fig.30 Frequency response property 5 (VCC = 6.0 V, Io = 500 mA)

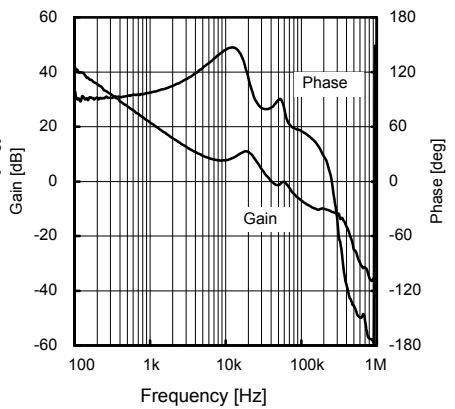
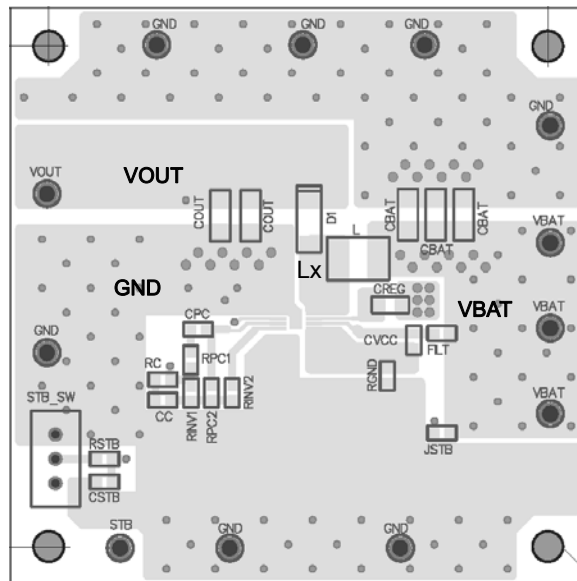

Fig.31 Frequency response property 6 (VCC = 8.4 V, Io = 500 mA)

● Reference Board Pattern



The radiation plate on the rear should be a GND flat surface of low impedance in common with the PGND flat surface. It is recommended to install a GND pin in another system as shown in the drawing without connecting it directly to this PGND

● Selection of Part for Applications

(1) Inductor

A shielded inductor that satisfies the current rating (current value, I_{pecac} as shown in the drawing below) and has a low DCR (direct resistance component) is recommended.

Inductor values affect inductor ripple current, which will cause output ripple. Ripple current can be reduced as the coil L value becomes larger and the switching frequency becomes higher.

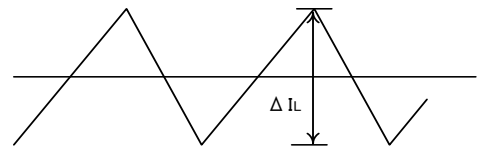

Fig.32 Inductor current

$$I_{peak} = I_{out} \times (V_{out}/V_{in}) / \eta + \Delta I_L / 2 \text{ [A]} \quad (1)$$

$$\Delta I_L = \frac{V_{in}}{L} \times \frac{V_{out} - V_{in}}{V_{out}} \times \frac{1}{f} \text{ [A]} \quad (2)$$

(η : Efficiency, ΔI_L : Output ripple current, f : Switching frequency)

As a guide, inductor ripple current should be set at about 20 to 50% of the maximum input current.

* Current over the coil rating flowing in the coil brings the coil into magnetic saturation, which may lead to lower efficiency or output oscillation. Select an inductor with an adequate margin so that the peak current does not exceed the rated current of the coil.

(2) Output capacitor

A ceramic capacitor with low ESR is recommended for output in order to reduce output ripple. There must be an adequate margin between the maximum rating and output voltage of the capacitor, taking the DC bias property into consideration.

Output ripple voltage is obtained by the following equation.

$$V_{pp} = I_{out} \times \frac{V_{out} - V_{in}}{f \times C_o \times V_{out}} + I_{out} \times R_{ESR} \text{ [V]} \dots (3)$$

Setting must be performed so that output ripple is within the allowable ripple voltage.

(3) Output voltage setting

The internal reference voltage of the ERROR AMP is 1.0 V. Output voltage is obtained by Equation (4) of Fig. 33, but it should be designed taking about 50 Ω , an error of NMOS ON resistance of SWOUT into consideration.

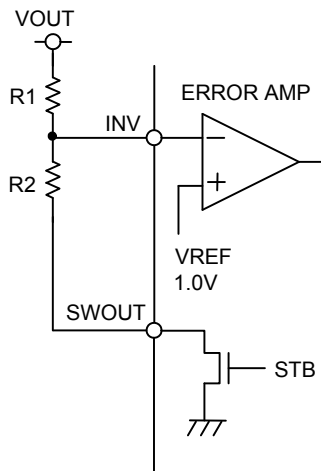

$$V_o = \frac{(R1+R2)}{R2} \times 1.0 \text{ [V]} \dots (4)$$

Fig.33 Setting of voltage feedback resistance

(4) DC/DC converter frequency response adjustment system

Condition for stable application

The condition for feedback system stability under negative feedback is that the phase delay is 135° or less when gain is 1 (0 dB). Since DC/DC converter application is sampled according to the switching frequency, the bandwidth GBW of the whole system (frequency at which gain is 0 dB) must be controlled to be equal to or lower than 1/10 of the switching frequency. In summary, the conditions necessary for the DC/DC converter are:

- Phase delay must be 135° or lower when gain is 1 (0 dB).
- Bandwidth GBW (frequency when gain is 0 dB) must be equal to or lower than 1/10 of the switching frequency.

To satisfy above two items, R₁, R₂, R₃, D_S and R_S in Fig. 34 should be set as follows.

[1] R₁, R₂, R₃

BD8311NUV incorporates phase compensation devices of R₄=62 kΩ and C₂=200pF. These C₂ and R₁, R₂, and R₃ values decide the primary pole that determines the bandwidth of DC/DC converter.

Primary pole point frequency

$$f_p = \frac{1}{2\pi \left\{ A \times \left(\frac{R_1 \cdot R_2}{R_1 + R_2} + R_3 \right) \times C_2 \right\}} \dots\dots\dots(1)$$

DC/DC converter DC Gain

$$\text{DC Gain} = A \times \frac{1}{B} \times \frac{V_{OUT}}{V_{OUT} - V_{IN}} \dots\dots\dots(2)$$

By Equations (1) and (2), the frequency f_{sw} of point 0 dB under limitation of the bandwidth of the DC gain at the primary pole point is as shown below.

$$f_{sw} = f_p \times \text{DC Gain} = \frac{1}{2\pi C_2 \times \left(\frac{R_1 \cdot R_2}{R_1 + R_2} + R_3 \right)} \times \frac{1}{B} \times \frac{V_{OUT}}{V_{OUT} - V_{IN}} \dots\dots\dots(3)$$

It is recommended that f_{sw} should be approx. 10 kHz. When load response is difficult, it may be set at approx. 20 kHz. By this setting, R₁ and R₂, which determine the voltage value, will be in the order of several hundred kΩ. Therefore, if an appropriate resistance value is not available and routing may cause noise, the use of R₃ enables easy setting.

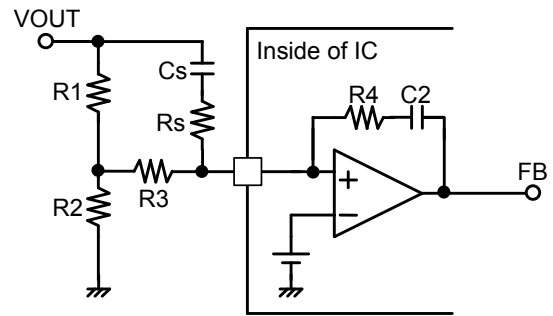

Fig.34 Example of phase compensation setting

- A: ERROR AMP Gain
About 100dB = 10⁵
- B: Oscillator amplification = 0.5
- V_{IN}: Input voltage
- V_{OUT}: Output voltage

[2] Cs and Rs setting

In the step-up DC/DC converter, the secondary pole point is caused by the coil and capacitor as expressed by the following equation.

$$f_{LC} = \frac{1-D}{2\pi\sqrt{LC}} \quad \dots\dots\dots(4)$$

D: ON Duty = $(V_{OUT} - V_{IN}) / V_{OUT}$

This secondary pole causes a phase rotation of 180°. To secure the stability of the system, put zero points in 2 places to perform compensation.

Zero point by built-in CR $f_{z1} = \frac{1}{2\pi R_4 C_2} = 13\text{kHz} \quad \dots\dots\dots(5)$

Zero point by Cs $f_{z1} = \frac{1}{2\pi(R_1+R_3)C_S} \quad \dots\dots\dots(6)$

Setting C_{S2} to be half to 2 times a frequency as large as f_{LC} provides an appropriate phase margin. It is desirable to set R_s at about 1/20 of (R_1+R_3) to cancel any phase boosting at high frequencies.

Those pole points are summarized in the figure below. The actual frequency property is different from the ideal calculation because of part constants. If possible, check the phase margin with a frequency analyzer or network analyzer, etc.. Otherwise, check for the presence or absence of ringing by load response waveform and also check for the presence or absence of oscillation under a load of an adequate margin.

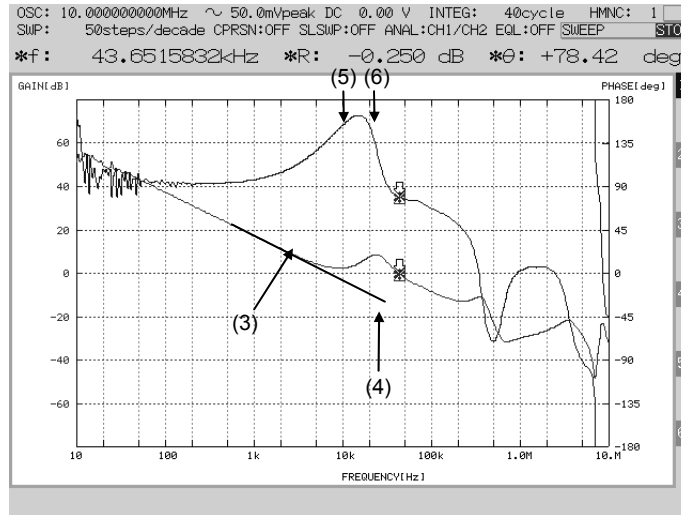
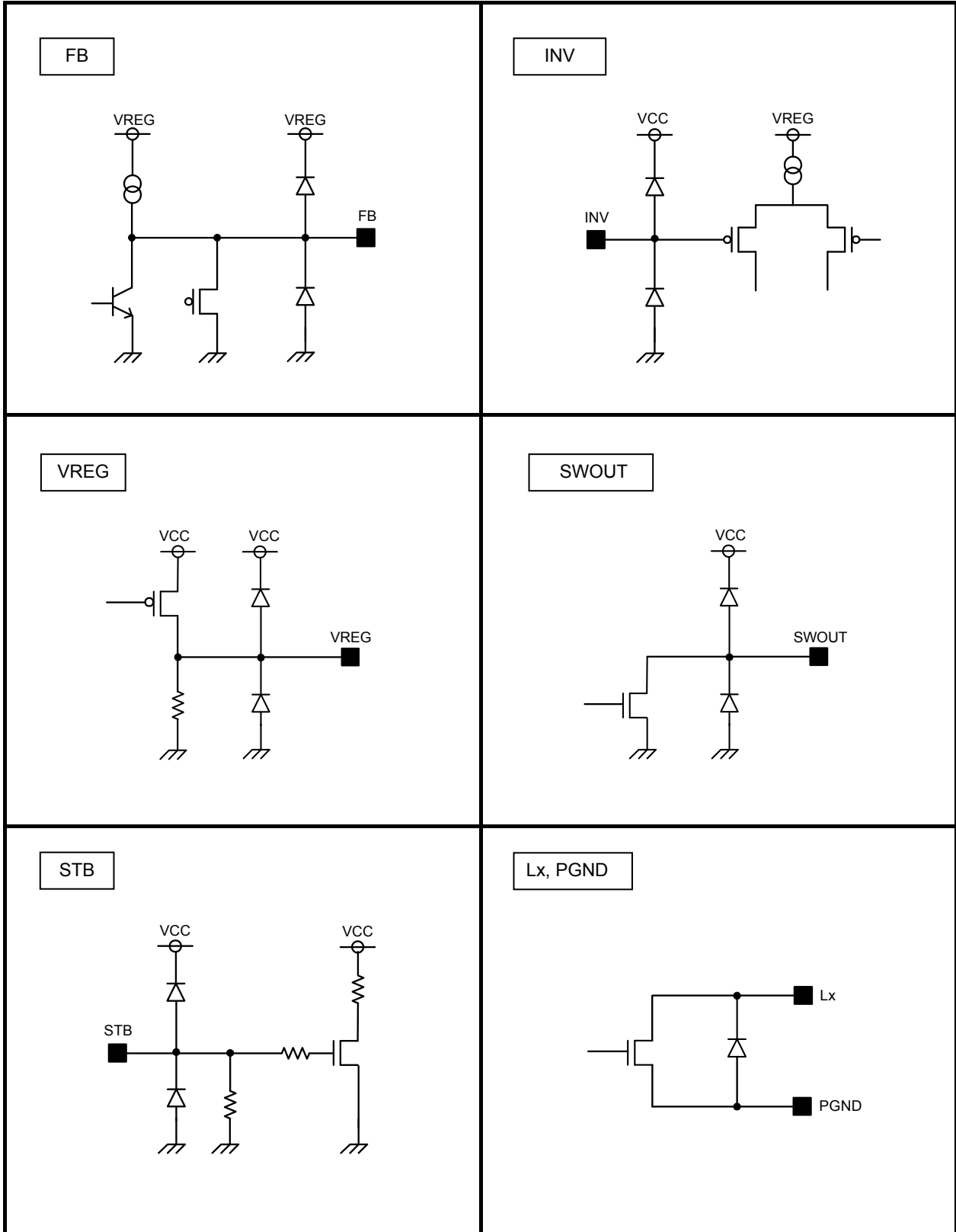

Fig. 35 Example of DC/DC converter frequency property (Measured with FRA5097 by NF Corporation)

● I/O Equivalence Circuit



●Notes for use

1) Absolute Maximum Rating

We dedicate much attention to the quality control of these products, however the possibility of deterioration or destruction exists if the impressed voltage, operating temperature range, etc., exceed the absolute maximum ratings. In addition, it is impossible to predict all destructive situations such as short-circuit modes, open circuit modes, etc. If a special mode exceeding the absolute maximum rating is expected, please review matters and provide physical safety means such as fuses, etc.

2) GND Potential

Keep the potential of the GND pin below the minimum potential at all times.

3) Thermal Design

Work out the thermal design with sufficient margin taking power dissipation (Pd) in the actual operation condition into account.

4) Short Circuit between Pins and Incorrect Mounting

Attention to IC direction or displacement is required when installing the IC on a PCB. If the IC is installed in the wrong way, it may break. Also, the threat of destruction from short-circuits exists if foreign matter invades between outputs or the output and GND of the power supply.

5) Operation under Strong Electromagnetic Field

Be careful of possible malfunctions under strong electromagnetic fields.

6) Common Impedance

When providing a power supply and GND wirings, show sufficient consideration for lowering common impedance and reducing ripple (i.e., using thick short wiring, cutting ripple down by LC, etc.) as much as you can.

7) Thermal Protection Circuit (TSD Circuit)

This IC contains a thermal protection circuit (TSD circuit). The TSD circuit serves to shut off the IC from thermal runaway and does not aim to protect or assure operation of the IC itself. Therefore, do not use the TSD circuit for continuous use or operation after the circuit has tripped.

8) Rush Current at the Time of Power Activation

Be careful of the power supply coupling capacity and the width of the power supply and GND pattern wiring and routing since rush current flows instantaneously at the time of power activation in the case of CMOS IC or ICs with multiple power supplies.

9) IC Terminal Input

This is a monolithic IC and has P+ isolation and a P substrate for element isolation between each element. P-N junctions are formed and various parasitic elements are configured using these P layers and N layers of the individual elements.

For example, if a resistor and transistor are connected to a terminal as shown on Fig.36:

○The P-N junction operates as a parasitic diode

when $GND > (\text{Terminal A})$ in the case of a resistor or when $GND > (\text{Pin B})$ in the case of a transistor (NPN)

○Also, a parasitic NPN transistor operates using the N layer of another element adjacent to the previous diode in the case of a transistor (NPN) when $GND > (\text{Pin B})$.

The parasitic element consequently rises under the potential relationship because of the IC's structure. The parasitic element pulls interference that could cause malfunctions or destruction out of the circuit. Therefore, use caution to avoid the operation of parasitic elements caused by applying voltage to an input terminal lower than the GND (P board), etc.

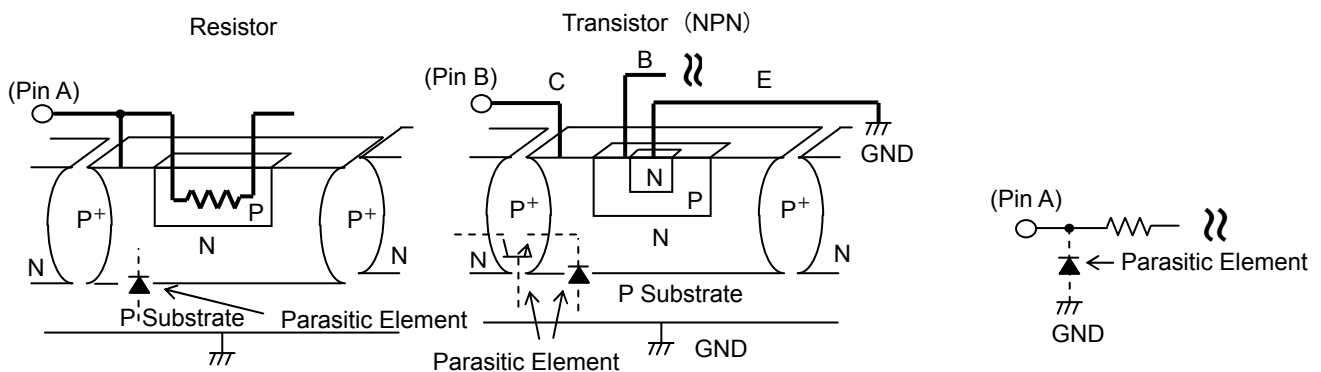
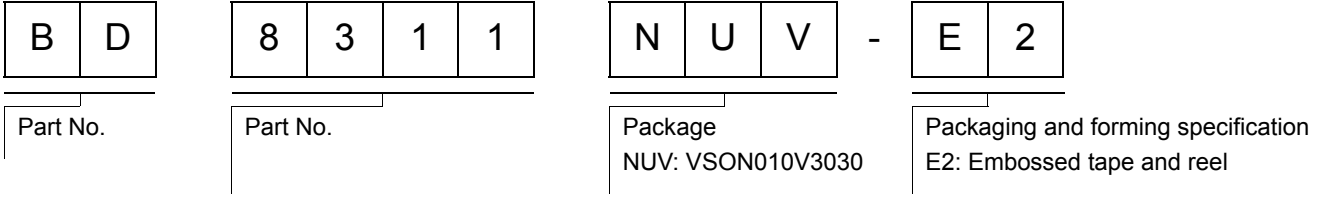
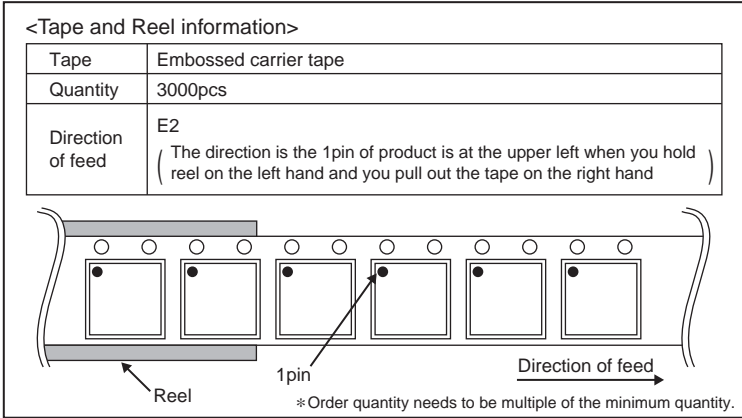
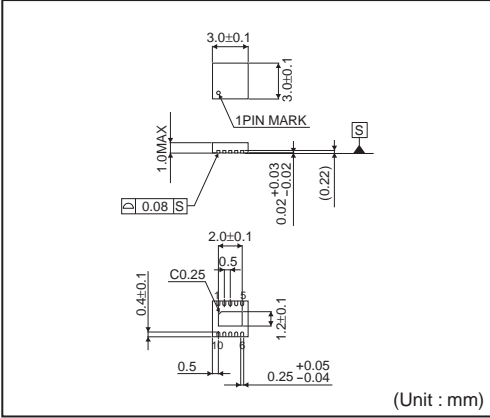

Fig.36 Example of simple structure of Bipolar IC

●Ordering part number



VSON010V3030



Notes

No copying or reproduction of this document, in part or in whole, is permitted without the consent of ROHM Co.,Ltd.

The content specified herein is subject to change for improvement without notice.

The content specified herein is for the purpose of introducing ROHM's products (hereinafter "Products"). If you wish to use any such Product, please be sure to refer to the specifications, which can be obtained from ROHM upon request.

Examples of application circuits, circuit constants and any other information contained herein illustrate the standard usage and operations of the Products. The peripheral conditions must be taken into account when designing circuits for mass production.

Great care was taken in ensuring the accuracy of the information specified in this document. However, should you incur any damage arising from any inaccuracy or misprint of such information, ROHM shall bear no responsibility for such damage.

The technical information specified herein is intended only to show the typical functions of and examples of application circuits for the Products. ROHM does not grant you, explicitly or implicitly, any license to use or exercise intellectual property or other rights held by ROHM and other parties. ROHM shall bear no responsibility whatsoever for any dispute arising from the use of such technical information.

The Products specified in this document are intended to be used with general-use electronic equipment or devices (such as audio visual equipment, office-automation equipment, communication devices, electronic appliances and amusement devices).

The Products specified in this document are not designed to be radiation tolerant.

While ROHM always makes efforts to enhance the quality and reliability of its Products, a Product may fail or malfunction for a variety of reasons.

Please be sure to implement in your equipment using the Products safety measures to guard against the possibility of physical injury, fire or any other damage caused in the event of the failure of any Product, such as derating, redundancy, fire control and fail-safe designs. ROHM shall bear no responsibility whatsoever for your use of any Product outside of the prescribed scope or not in accordance with the instruction manual.

The Products are not designed or manufactured to be used with any equipment, device or system which requires an extremely high level of reliability the failure or malfunction of which may result in a direct threat to human life or create a risk of human injury (such as a medical instrument, transportation equipment, aerospace machinery, nuclear-reactor controller, fuel-controller or other safety device). ROHM shall bear no responsibility in any way for use of any of the Products for the above special purposes. If a Product is intended to be used for any such special purpose, please contact a ROHM sales representative before purchasing.

If you intend to export or ship overseas any Product or technology specified herein that may be controlled under the Foreign Exchange and the Foreign Trade Law, you will be required to obtain a license or permit under the Law.



Thank you for your accessing to ROHM product informations.
More detail product informations and catalogs are available, please contact us.

ROHM Customer Support System

<http://www.rohm.com/contact/>