

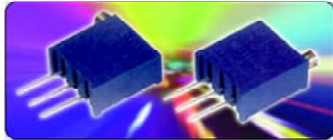

DB LECTRO
COMPOSANTS ÉLECTRONIQUES
ELECTRONIC COMPONENTS



- Multiturn/ Cermet/ Industrial /sealed
- 5 terminal styles
- RoHS Compliant



3296 Square Trimming Potentiometer

Electrical Characteristics

Standard Resistance Range..... $50\ \Omega \sim 2M\ \Omega$
Resistance Tolerance..... $\pm 10\%$
Absolute Minimum Resistance..... $\leq 1\%R$ or $10\ \Omega$
Contact Resistance Variation...CRV $\leq 3\%$ or $5\ \Omega$
Insulation Resistance..... $R1 \geq 1G\ \Omega$ (100Vac)
Withstand Voltage.....640Vac

Effective Travel.....28 turns nom

Environmental Characteristics

(Power Rating) (315 volts max)
..... $0.5W@70^\circ C, 0W@125^\circ C$
Temperature Range..... $-55^\circ C \sim 125^\circ C$
Temperature Coefficient..... $\pm 250\text{ppm}/^\circ C$
Temperature Variation... $-55^\circ C, 30\text{min}, +125^\circ C$
.....30min、5cycles
..... $\Delta R \leq 5\%R, \Delta(Uab/Uac) \leq 5\%$
Vibration..... $10 \sim 500\text{Hz}, 0.75\text{mm}, 6\text{h},$
..... $\Delta R \leq 5\%R, \Delta(Uab/Uac) \leq 7.5\%R$
Collision..... $390\text{m/s}^2, 4000\text{cycles}, \Delta R \leq 5\%R$
Electrical Endurance at $70^\circ C$ $0.5W@70^\circ C$
.....1000h, $\Delta R \leq 10\%R, \text{CRV} \leq 3\%$ or $5\ \Omega$

Rotational Life.....200cycles

..... $\Delta R \leq 10\%R, \text{CRV} \leq 3\%$ or $5\ \Omega$

Physical Characteristics

Starting Torque..... $\leq 35\text{mN}\cdot\text{m}$

Marking.....Resistance Tolerance

... (when no identification, it is of $\pm 10\%$)

.....Resistance Code、Model

Standard Packaging...50pcs,per tube

RoHS Compliant

Common Dimensions

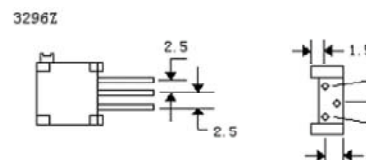
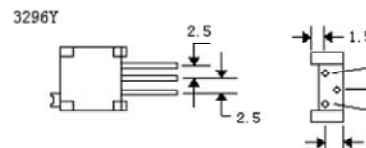
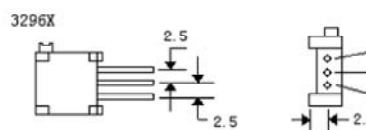
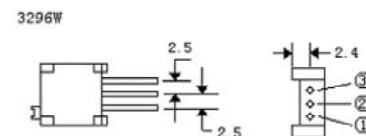
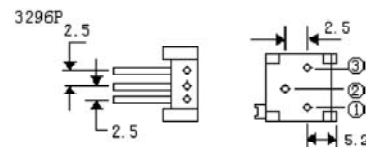
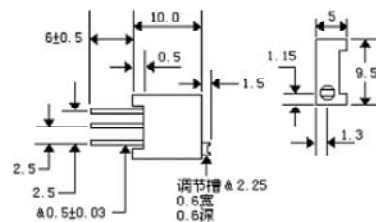

How To Order

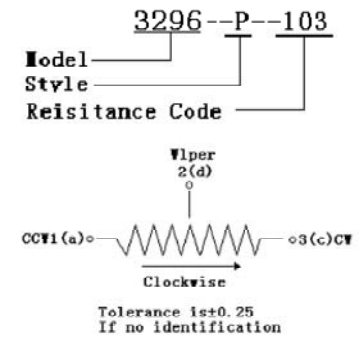

Standard Resistance Table

Resistance (Ohms)	Resistance Code
10	100
20	200
50	500
100	101
200	201
500	501
1,000	102
2,000	202
5,000	502
10,000	103
20,000	203
25,000	253
50,000	503
100,000	104
200,000	204
250,000	254
500,000	504
1,000,000	105
2,000,000	205