

Features

- Dual TVS in Common Anode Configuration
- 24W/40W Peak Power Dissipation Rating @ 1.0ms (Unidirectional)
- 225 mW Power Dissipation
- Ideally Suited for Automatic Insertion
- Low Leakage
- Lead Free/RoHS Compliant (Note 5)

Mechanical Data

- Case: SOT-23
- Case Material: Molded Plastic. UL Flammability Classification 94V-0
- Moisture Sensitivity: Level 1 per J-STD-020C
- Terminals: Solderable per MIL-STD-202, Method 208
- Polarity: See Diagram
- Lead Free Plating (Matte Tin Finish annealed over Alloy 42 leadframe).
- Marking: Marking Code & Date Code, See Page 2
- Marking Code: See Table Below and Page 2
- Ordering Information: See Page 2
- ESD Rating Exceeding 16kV per the Human Body Model (Note 4)
- Weight: 0.008 grams (approximate)

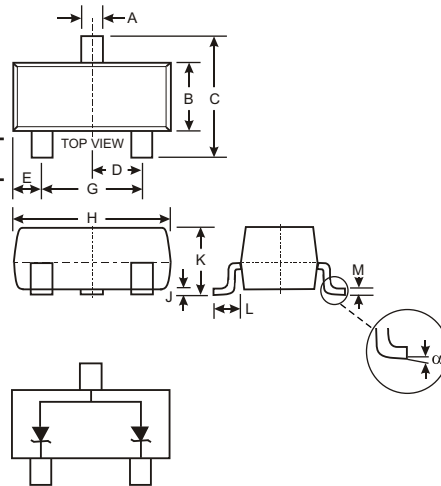

SOT-23		
Dim	Min	Max
A	0.37	0.51
B	1.20	1.40
C	2.30	2.50
D	0.89	1.03
E	0.45	0.60
G	1.78	2.05
H	2.80	3.00
J	0.013	0.10
K	0.903	1.10
L	0.45	0.61
M	0.085	0.180
	0	8
All Dimensions in mm		

Maximum Ratings @ T_A = 25°C unless otherwise specified

Characteristic	Symbol	Value	Unit
Power Dissipation (Note 1)	P _d	225	mW
Peak Power Dissipation (Note 2) MMBZ5V6AL - MMBZ10VAL	P _{pk}	24	W
Peak Power Dissipation (Note 2) MMBZ15VAL - MMBZ33VAL	P _{pk}	40	W
Thermal Resistance, Junction to Ambient Air (Note 1)	R _{JA}	556	°C/W
Operating and Storage Temperature Range	T _j , T _{STG}	-65 to +150	°C

Electrical Characteristics @ T_A = 25°C unless otherwise specified

24 Watt (V_F = 0.9V max @ I_F = 10mA)

Type Number	Marking Code	V _{RWM} Volts	I _R @ V _{RWM} A	Breakdown Voltage			V _C @ I _{PP} (Note 2)		Typical Temperature Coefficient T _c (mV/ C)	
				V _{BR} (Note 3) (V)			V _C V	I _{PP} A		
				Min	Nom	Max				mA
MMBZ5V6AL	K9A	3	5.0	5.32	5.6	5.88	20	8.0	3.0	1.8

24 Watt (V_F = 1.1V max @ I_F = 200mA)

Type Number	Marking Code	V _{RWM} Volts	I _R @ V _{RWM} A	Breakdown Voltage			V _C @ I _{PP} (Note 2)		Typical Temperature Coefficient T _c (%/ C)	
				V _{BR} (Note 3) (V)			V _C V	I _{PP} A		
				Min	Nom	Max				mA
MMBZ6V2AL	K9B	3.0	0.5	5.89	6.2	6.51	1.0	8.7	2.76	+0.04
MMBZ6V8AL	K9C	4.5	0.5	6.46	6.8	7.14	1.0	9.6	2.5	+0.045
MMBZ9V1AL	K9D	6.0	0.3	8.65	9.1	9.56	1.0	14	1.7	+0.065
MMBZ10VAL	K9E	6.5	0.3	9.50	10	10.5	1.0	14.2	1.7	+0.065

- Note: 1. Device mounted on FR-5 PCB 1.0 x 0.75 x 0.062 inch pad layout as shown on Diodes Inc. suggested pad layout AP02001, which can be found on our website at <http://www.diodes.com/datasheets/ap02001.pdf>. 200mW per element must not be exceeded.
2. Non-repetitive current pulse per Figure 2 and derate above T_A = 25 C per Figure 1.
3. Short duration pulse test used to minimize self-heating effect.
4. MMBZ5V6AL and MMBZ15VAL exceed 16kV ESD rating, all other voltages exceed 8kV ESD rating.
5. No purposefully added lead.



40 Watt ($V_F = 1.1V \text{ max @ } I_F = 200mA$)

Type Number	Marking Code	V_{RWM} Volts	$I_R @ V_{RWM}$ nA	Breakdown Voltage			@ I_T mA	$V_C @ I_{PP}$ (Note 2)		Typical Temperature Coefficient T_c (%/ C)
				V_{BR} (Note 3) (V)				V_C V	I_{PP} A	
				Min	Nom	Max				
MMBZ15VAL	K9K	12	50	14.25	15	15.75	1.0	21	1.9	+0.080
MMBZ18VAL	K9L	14.5	50	17.10	18	18.90	1.0	25	1.6	+0.090
MMBZ20VAL	K9N	17	50	19.00	20	21.00	1.0	28	1.4	+0.090
MMBZ27VAL	K9Q	22	50	25.65	27	28.35	1.0	40	1.0	+0.090
MMBZ33VAL	K9T	26	50	31.35	33	34.65	1.0	46	0.87	+0.090

Ordering Information (Note 6)

Device	Packaging	Shipping
(Type number)-7*-F	SOT-23	3000/Tape & Reel

* Example: 5.6V type = MMBZ5V6AL-7-F.

Notes: 6. For Packaging Details, go to our website at <http://www.diodes.com/datasheets/ap02007.pdf>.

Marking Information

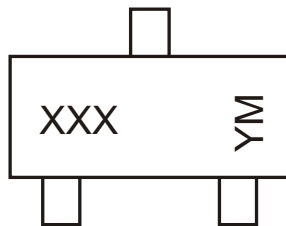

XXX = Product Type Marking Code
 YM = Date Code Marking
 Y = Year ex: N = 2002
 M = Month ex: 9 = September

Date Code Key

Year	2001	2002	2003	2004	2005	2006	2007	2008	2009
Code	M	N	P	R	S	T	U	V	W

Month	Jan	Feb	March	Apr	May	Jun	Jul	Aug	Sep	Oct	Nov	Dec
Code	1	2	3	4	5	6	7	8	9	O	N	D

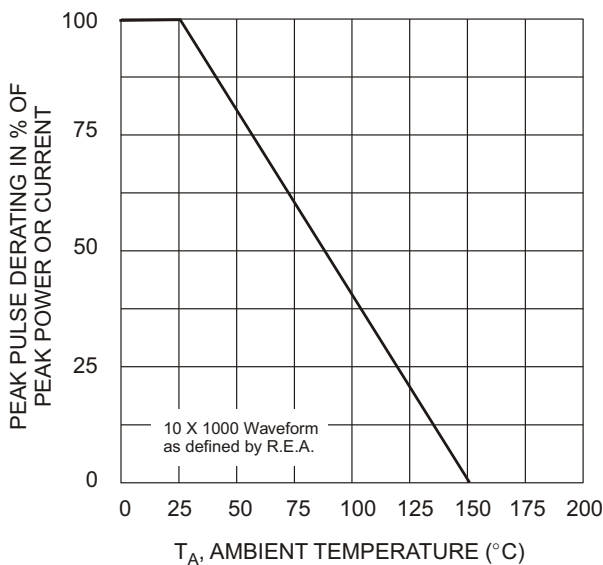

Fig. 1 Pulse Derating Curve

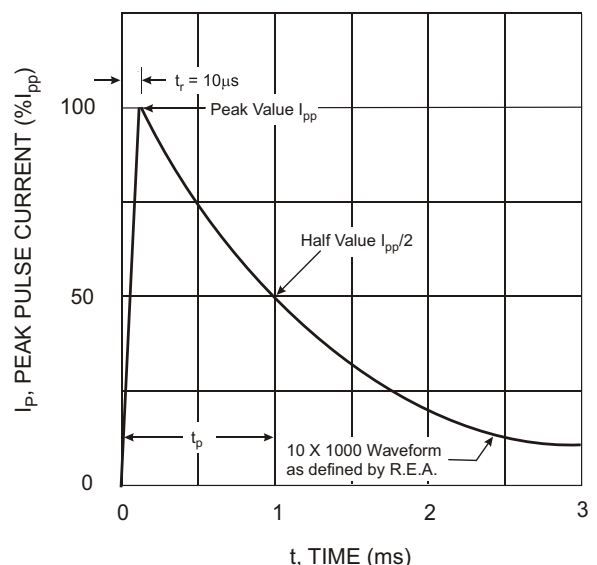

Fig. 2 Pulse Waveform

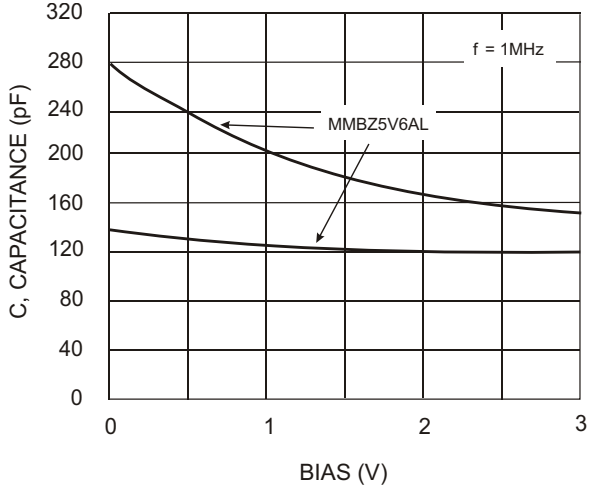

Fig. 3 Typical Capacitance vs. Bias Voltage
(Lower curve is Bidirectional mode,
Upper curve is Unidirectional mode)

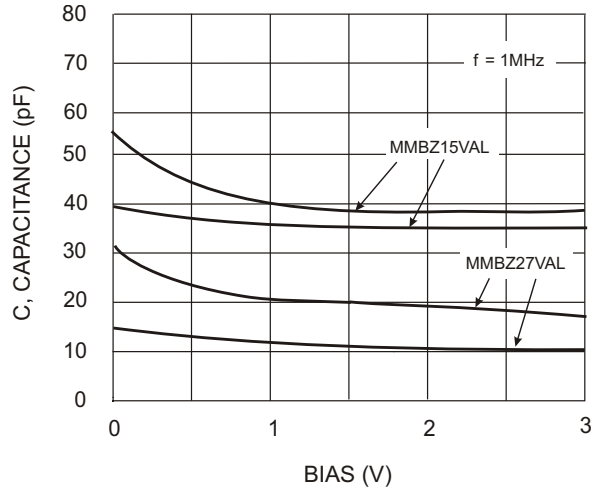

Fig. 4 Typical Capacitance vs. Bias Voltage
(Lower curve is Bidirectional mode,
Upper curve is Unidirectional mode)

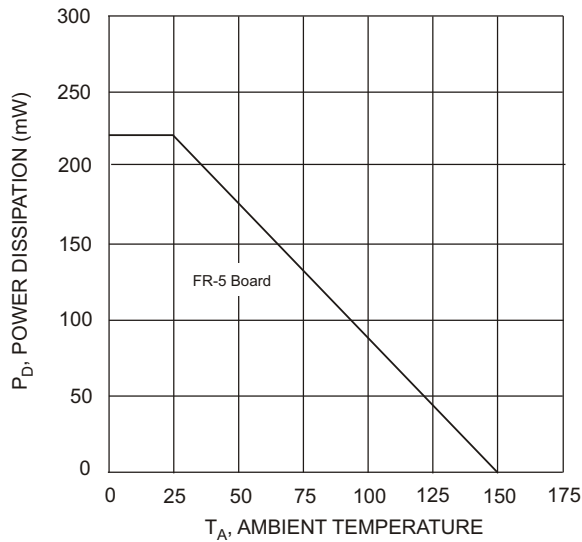

Fig. 5 Steady State Power Derating Curve

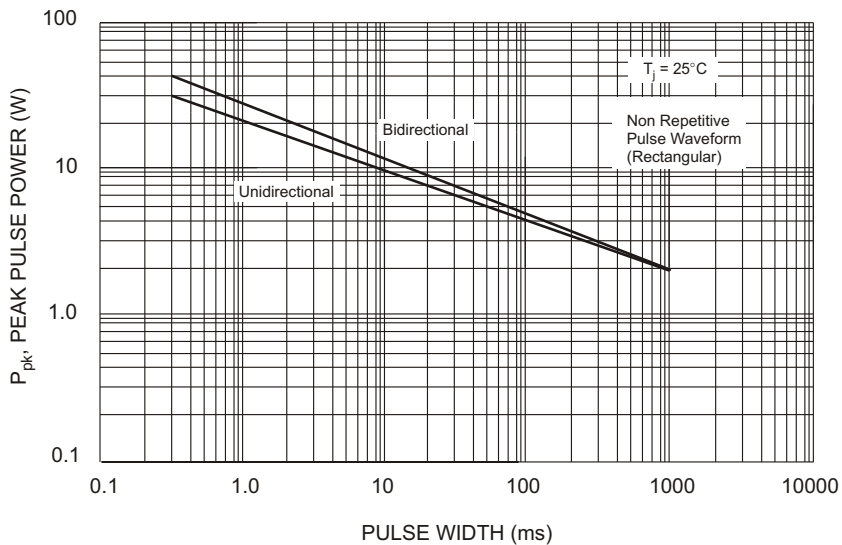

Fig. 6 Pulse Rating Curve,
 P_{pk} (W) vs. Pulse Width (ms)

Power is defined as $P_{pk} = V_C \times I_{pp}$

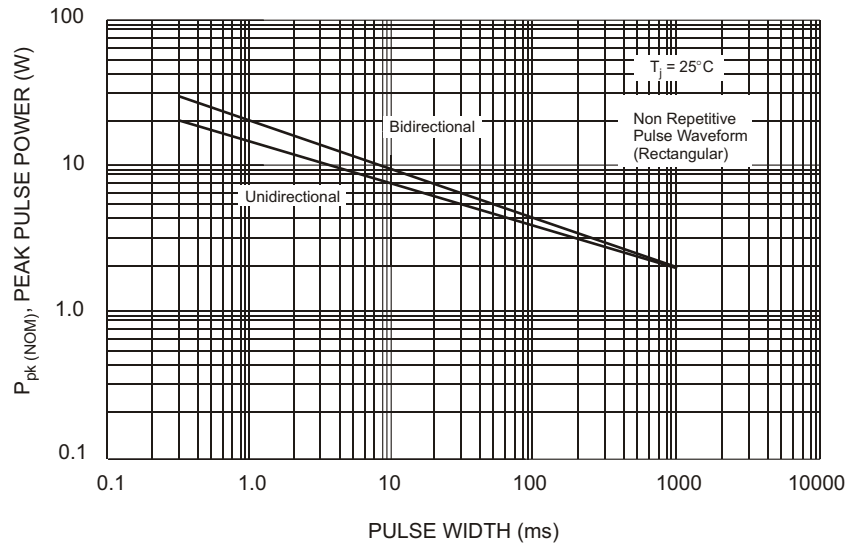

Fig. 7 Pulse Rating Curve,
 $P_{pk(NOM)}$ (W) vs. Pulse Width (ms)

Power is defined as $P_{pk(NOM)} = V_{Z(NOM)} \times I_{pp}$
where $V_{Z(NOM)}$ is the nominal Zener voltage
measured at the low test current used
for voltage classification

IMPORTANT NOTICE

Diodes, Inc. and its subsidiaries reserve the right to make changes without further notice to any product herein to make corrections, modifications, enhancements, improvements, or other changes. Diodes, Inc. does not assume any liability arising out of the application or use of any product described herein; neither does it convey any license under its patent rights, nor the rights of others. The user of products in such applications shall assume all risks of such use and will agree to hold Diodes Incorporated and all the companies whose products are represented on our website, harmless against all damages.

LIFE SUPPORT

The products located on our website at www.diodes.com are not recommended for use in life support systems where a failure or malfunction of the component may directly threaten life or cause injury without the expressed written approval of Diodes Incorporated.