

VI TELEFILTER**Filter specification****TFS 549A****1/5****Measurement condition**

Ambient temperature: 23 °C
 Input power level: 0 dBm
 Terminating impedance: *
 for input: 956 Ω || -3,0 pF
 for output: 718 Ω || -3,6 pF

Characteristics**Remark:**

The reference level for the relative attenuation a_{rel} of TFS 549A is the minimum of the pass band attenuation a_{min} . This value is defined as the insertion loss a_e . The centre frequency f_C is the arithmetic mean value of the upper and lower frequencies at the 1 dB filter attenuation level relative to the insertion loss a_e . The given values for the relative attenuation a_{rel} and the group delay ripple have to be reached at the frequencies given below, even if the centre frequency f_C is shifted due to the temperature coefficient of frequency TC_f in the operating temperature range and due to a production tolerance for the centre frequency f_C .

D a t a		typ. value		tolerance / limit	
Insertion loss (reference level)		a_e	13,8 dB	max.	15 dB
Nominal frequency		f_N	-		549,5 MHz
Passband			-	f_N	$\pm 2,5$ MHz
Pass band ripple		within PB	-	max.	0,5 dB
Relative attenuation		a_{rel}			
f_N	MHz ... $f_N \pm 2,5$ MHz		0,5 dB	max.	1 dB
$f_N \pm 4$	MHz ... $f_N \pm 6,5$ MHz		8 dB	min.	3 dB
$f_N \pm 6,5$	MHz ... $f_N \pm 22$ MHz		44 dB	min.	39 dB
$f_N - 548,5$	MHz ... $f_N - 22$ MHz		55 dB	min.	50 dB
$f_N + 22$	MHz ... $f_N + 451,5$ MHz		54 dB	min.	50 dB
Absolute group delay			600 ns	max.	800 ns
Group delay ripple within PB			10 ns	max.	50 ns
Phase linearity (p-p)					
at any 2 MHz band width in PB			1,8 deg	max.	2,55 deg
Triple transit response suppression			53 dB	min.	30 dB
VSWR			1,5:1	max.	2:1
Operating temperature range		OTR	-		- 10°C ... + 65°C
Storage temperature range			-		- 25°C ... + 75°C
Turn over temperature			28 °C		-
Temperature coefficient of frequency		TC_f **	-0,05 ppm/K ²		-

*) The terminating impedances depend on parasitics and q-values of matching elements and the board used, and are to be understood as reference values only. Should there be additional questions do not hesitate to ask for an application note or contact our design team.

**) $\Delta f(\text{Hz}) = TC_f(\text{ppm/K}^2) \times (T - T_0)^2 \times f_{T0}(\text{MHz})$

Generated:**Checked / Approved:**

Tele Filter GmbH
 Potsdamer Straße 18
 D 14 513 TELTOW / Germany
 Tel: (+49) 3328 4784-0 / Fax: (+49) 3328 4784-30
 E-Mail: tft@telefilter.com

VI TELEFILTER reserves the right to make changes to the product(s) and/or information contained herein without notice. No liability is assumed as a result of their use or application. No rights under any patent accompany the sale of any such product(s) or information.

Filter characteristic

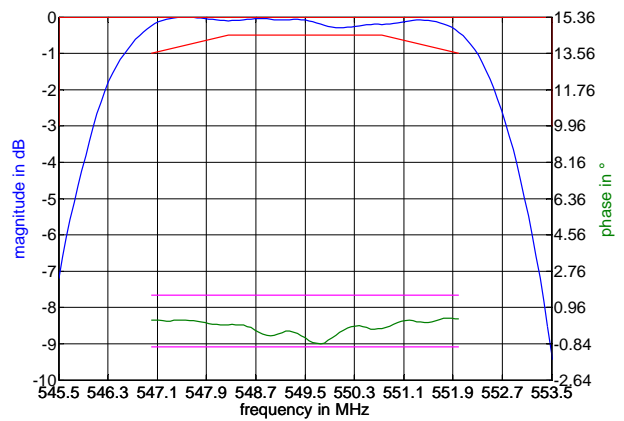
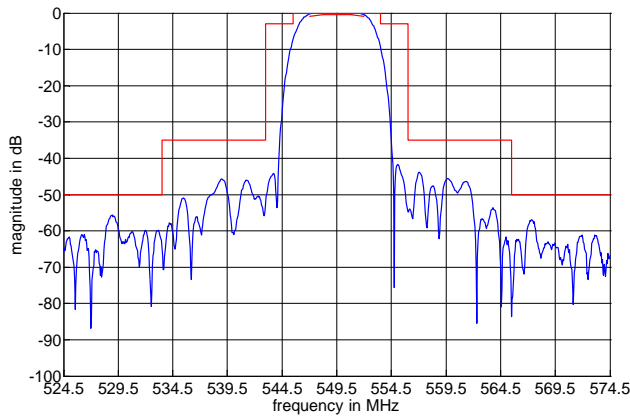

Construction and pin connection

(All dimensions in mm)

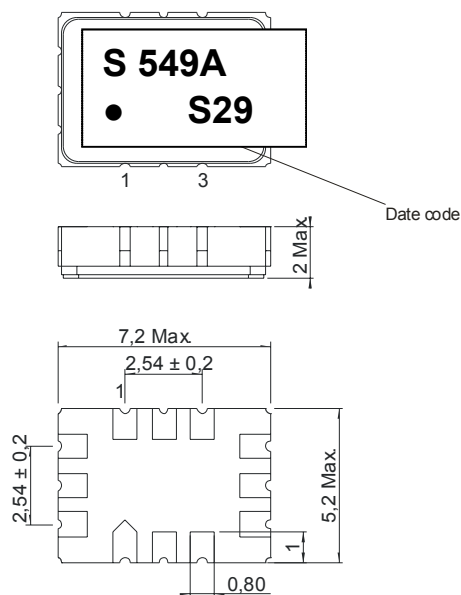

1	Ground
2	Ground
3	Output RF Return
4	Output
5	Ground
6	Ground
7	Ground
8	Ground
9	Input RF Return
10	Input
11	Ground
12	Ground

Date code:	Year + week
S	2004
T	2005
U	2006
...	

50 Ohm Test circuit

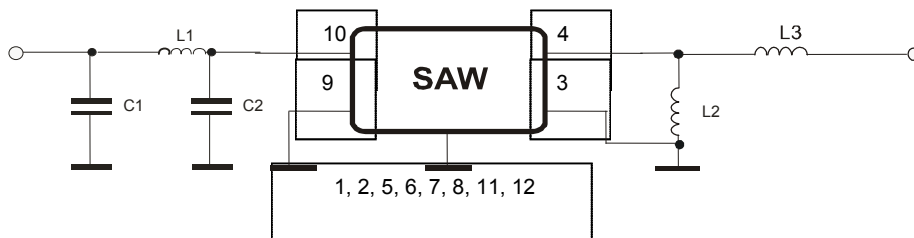

Tele Filter GmbH
 Potsdamer Straße 18
 D 14 513 TELTOW / Germany
 Tel: (+49) 3328 4784-0 / Fax: (+49) 3328 4784-30
 E-Mail: tft@telefilter.com

VI TELEFILTER reserves the right to make changes to the product(s) and/or information contained herein without notice. No liability is assumed as a result of their use or application. No rights under any patent accompany the sale of any such product(s) or information.

Stability characteristics

After the following tests the filter shall meet the whole specification:

1. Shock: 500g, 18 ms, half sine wave, 3 shocks each plane;
DIN IEC 68 T2 - 27
2. Vibration: 10 Hz to 500 Hz, 0,35 mm or g respectively, 1 octave per min, 10 cycles per plan, 3 plans;
DIN IEC 68 T2 - 6
3. Change of temperature: -55 °C to 125°C / 30 min. each / 10 cycles
DIN IEC 68 part 2 – 14 Test N
4. Resistance to solder heat (reflow): reflow possible: twice max.;
for temperature conditions refer to the attached "Air reflow temperature conditions" on page 4;

Packing

Tape & Reel: IEC 286 – 3, with exception of value for N and minimum bending radius;
tape type II, embossed carrier tape with top cover tape on the upper side;

max. pieces of filters peer reel:	3000
reel of empty components at start:	min. 300 mm
reel of empty components at start including leader:	min. 500 mm
trailer:	min. 300 mm

Tape (all dimensions in mm)

- W : 16,00 ± 0,3
- Po : 4,00 ± 0,1
- Do : 1,50 +0,1/-0
- E : 1,75 ± 0,1
- F : 7,50 ± 0,1
- G(min) : 0,60
- P2 : 2,00 ± 0,1
- P1 : 8,00 ± 0,1
- D1(min) : 1,50
- Ao : 5,50 ± 0,1
- Bo : 7,50 ± 0,1
- Ct : 13,5 ± 0,1

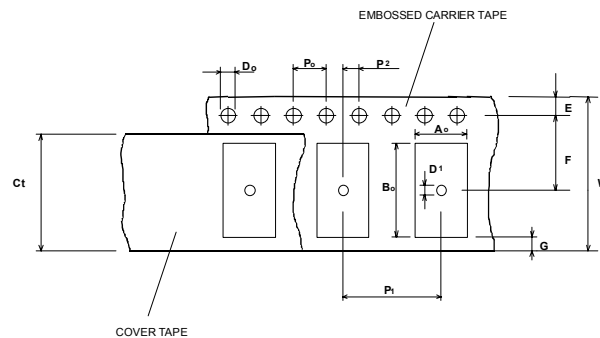

Reel (all dimensions in mm)

- A : 330
- W1 : 16,4 +2/-0
- W2(max) : 22,4
- N(min) : 50
- C : 13,0 +0,5/-0,2

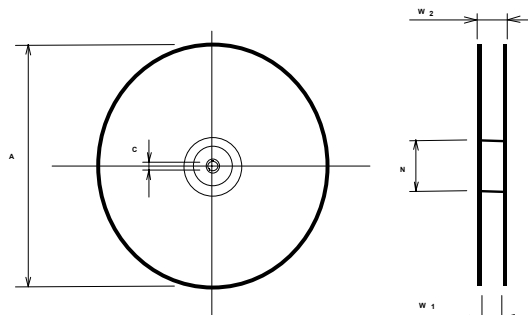

The minimum bending radius is 45 mm. The mounting surface of the filters faces the bottom side of the embossed carrier tape. Marking of the filters can be read if the upper side of the carrier tape is regarded with the sprocket holes on the right.

Tele Filter GmbH
Potsdamer Straße 18
D 14 513 TELTOW / Germany
Tel: (+49) 3328 4784-0 / Fax: (+49) 3328 4784-30
E-Mail: tft@telefilter.com

VI TELEFILTER reserves the right to make changes to the product(s) and/or information contained herein without notice. No liability is assumed as a result of their use or application. No rights under any patent accompany the sale of any such product(s) or information.

Air reflow temperature conditions

1st and 2nd air reflow profile

Name:	pre-heating periods	main-heating periods	peak temperature
Temperature:	150 °C - 170 °C	over 200 °C	255 °C ± 5 °C
Time:	60 sec. - 90 sec.	20 sec. - 25 sec.	

Chip-mount air reflow profile

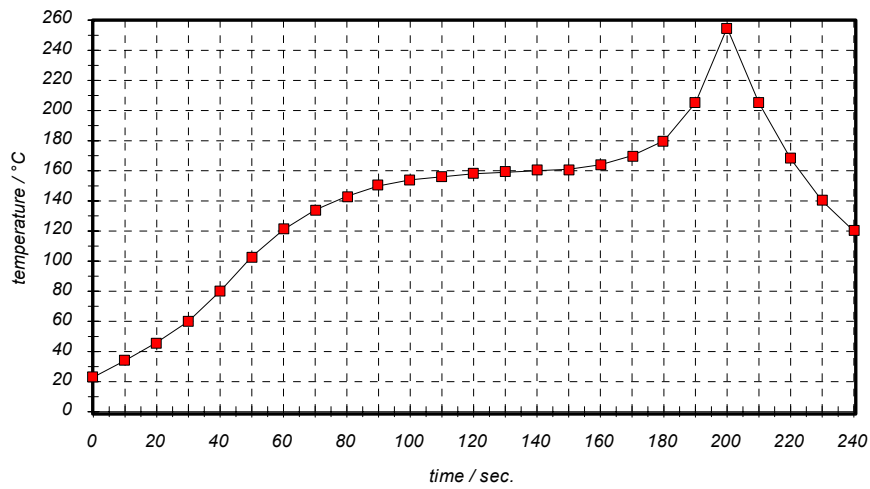

Table for temperature vs. time during the air reflow process

Tolerance of temperatures: ± 5 °C

time / sec.	temperature / °C	time / sec.	temperature / °C
0	23	140	160
10	34	150	161
20	46	160	164
30	60	170	170
40	80	180	180
50	103	190	205
60	121	195	230
70	134	200	255
80	143	205	230
90	150	210	205
100	154	215	180
110	156	220	165
120	158	230	140
130	159	240	120

Tele Filter GmbH
 Potsdamer Straße 18
 D 14 513 TELTOW / Germany
 Tel: (+49) 3328 4784-0 / Fax: (+49) 3328 4784-30
 E-Mail: tft@telefilter.com

VI TELEFILTER reserves the right to make changes to the product(s) and/or information contained herein without notice. No liability is assumed as a result of their use or application. No rights under any patent accompany the sale of any such product(s) or information.

VI TELEFILTER**Filter specification****TFS 549A****5/5**

Version	Reason of Changes	Name	Date
1.0	- generate development specification	Roizengaft	02.02.2004
1.1	- matching circuit added	Steiner	12.02.2004
1.2	- terminating impedance, typical values and filter characteristic added - matching configuration corrected	Pfeiffer	14.07.2004

Tele Filter GmbH
Potsdamer Straße 18
D 14 513 TELTOW / Germany
Tel: (+49) 3328 4784-0 / Fax: (+49) 3328 4784-30
E-Mail: tft@telefilter.com

VI TELEFILTER reserves the right to make changes to the product(s) and/or information contained herein without notice. No liability is assumed as a result of their use or application. No rights under any patent accompany the sale of any such product(s) or information.