

VI TELEFILTER**Filter specification****TFS 280G****1/5****Measurement condition**

Ambient temperature:	22	°C
Input power level:	0 ± 2	dBm
Source and load impedance:	50 Ω	
Terminating impedances *		
Input:	275 Ω	-7,7 pF
Output:	162 Ω	-10,6 pF

Characteristics**Remark:**

The reference level for the relative attenuation a_{rel} of TFS280G is the minimum of the pass band attenuation a_{min} . This value is defined as the insertion loss a_e . The centre frequency f_c is the arithmetic mean value of the upper and lower frequencies at the 3 dB filter attenuation level relative to the insertion loss a_e . The given values for the relative attenuation a_{rel} and the group delay ripple have to be reached at the frequencies given below, even if the centre frequency f_c is shifted due to the temperature coefficient of frequency TC_f in the operating temperature range and due to a production tolerance for the centre frequency f_c .

D a t a		typ. value	limit
Insertion loss	$a_e = a_{min}$	11,3 dB	max. 12 dB
Nominal frequency	f_N	-	280,0 MHz
Centre frequency	f_c	280,0 MHz	-
Relative attenuation	a_{rel}		
$f_N - 20$ MHz ... $f_N + 20$ MHz		0,8 dB	max. 1 dB
10 MHz ... $f_N - 32$ MHz		41 dB	min. 40 dB
$f_N + 32$ MHz ... $f_N + 40$ MHz		38 dB	min. 37 dB
$f_N + 40$ MHz ... $f_N + 220$ MHz		41 dB	min. 40 dB
Group delay ripple GDR	$f_N - 17$ MHz ... $f_N + 17$ MHz	38 ns	max. 75 ns
Input power level		-	max. + 10 dBm
Operating temperature range		-	- 40 °C ... + 85 °C
Storage temperature range		-	- 40 °C ... + 85 °C
Temperature coefficient of frequency	TC_f	-87 ppm/K	-

*) The terminating impedances depend on parasitics and q-values of matching elements and the board used, and are to be understood as reference values only. Should there be additional questions, do not hesitate to ask for an application note or contact our design team.

**) $\Delta f(\text{Hz}) = TC_f(\text{ppm/K}) \times (T - T_0) \times f_{T0}(\text{MHz})$

Generated:**Checked / Approved:**

Tele Filter GmbH
 Potsdamer Straße 18
 D 14 513 TELTOW / Germany
 Tel: (+49) 3328 4784-0 / Fax: (+49) 3328 4784-30
 E-Mail: tft@telefilter.com

VI TELEFILTER reserves the right to make changes to the product(s) and/or information contained herein without notice. No liability is assumed as a result of their use or application. No rights under any patent accompany the sale of any such product(s) or information.

Filter characteristic

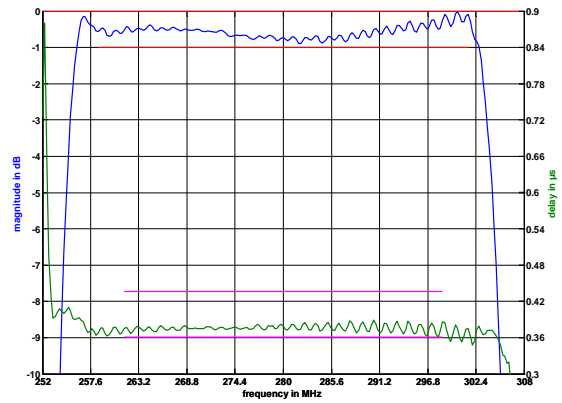
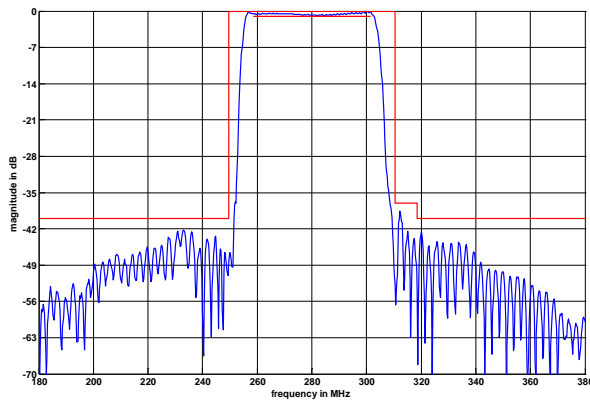

Construction and pin connection

(All dimensions in mm)

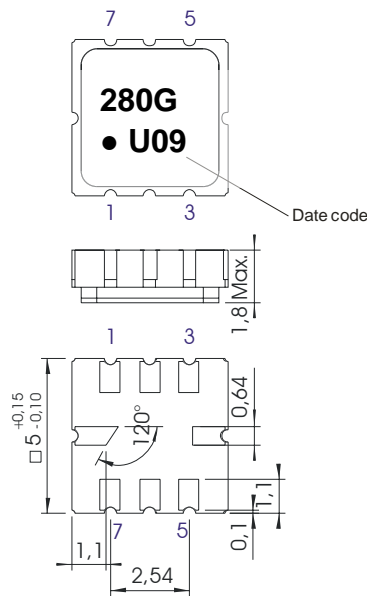

- 1 Input RF Return
- 2 Input
- 3 Ground
- 4 Ground
- 5 Output RF Return
- 6 Output
- 7 Ground
- 8 Ground

Date code: Year + week
 U 2006
 V 2007
 W 2008
 ...

50 Ohm Test circuit

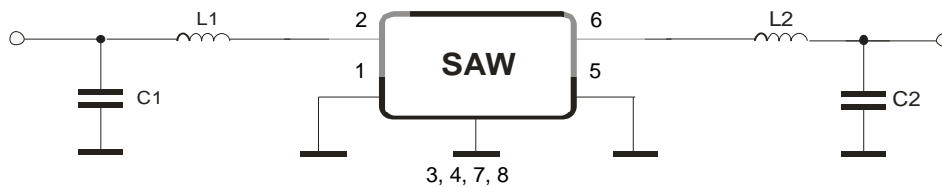

Tele Filter GmbH
 Potsdamer Straße 18
 D 14 513 TELTOW / Germany
 Tel: (+49) 3328 4784-0 / Fax: (+49) 3328 4784-30
 E-Mail: tft@telefilter.com

VI TELEFILTER reserves the right to make changes to the product(s) and/or information contained herein without notice. No liability is assumed as a result of their use or application. No rights under any patent accompany the sale of any such product(s) or information.

Stability characteristics

1. High Temperature (IEC 60068 -3-1)
1,000 hours at +85C
2. Low Temperature (IEC 60068 -3-1)
1,000 hours at - 40C
3. Humidity (IEC 60068 -2-78)
1,000 hours at 85% /85C
4. Thermal Shock (IEC60068-2-14)
-55 °C to 125°C / 30 min. each / 10 cycles
5. Vibration (IEC 60068 -2-6)
10 Hz to 500 Hz, 0,35 mm or 5g respectively, 1 octave per min, 10 cycles per plan, 3 plans
6. Shock (IEC 60068 -2-27)
500g, 1 ms, half sine wave, 3 shocks each plane
7. Reflow Profile (defined at specification)
260°C +/- 5°C for 10 seconds, 2 cycles
8. Solerability
235°C +/- 5°C for 15 seconds, 1 cycle
9. Pullability, Distortion
according to MIL-STD 883 method 2004.5 Condition D

This filter is RoHS compliant (2002/95/EG, 2005/618/EG)

Packing

Tape & Reel: IEC 286 – 3, with exception of value for N and minimum bending radius;
tape type II, embossed carrier tape with top cover tape on the upper side;

max. pieces of filters per reel: 3000
 reel of empty components at start: min. 300 mm
 reel of empty components at start including leader: min. 500 mm
 trailer: min. 300 mm

Pull Off Direction →

Tape (all dimensions in mm)

- W : 12,00 ± 0,3
- Po : 4,00 ± 0,1
- Do : 1,50 +0,1/-0
- E : 1,75 ± 0,1
- F : 5,50 ± 0,05
- G(min) : 0,75
- P2 : 2,00 ± 0,05
- P1 : 8,00 ± 0,1
- D1(min) : 1,50
- Ao : 5,30 ± 0,1
- Bo : 5,30 ± 0,1
- Ct : 9,5 ± 0,1

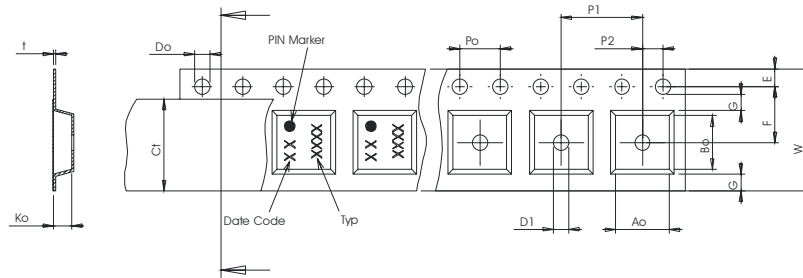

Reel (all dimensions in mm)

- A : 330
- W1 : 12,4 +2/-0
- W2(max) : 18,4
- N(min) : 50
- C : 13,0 +0,5/-0,2

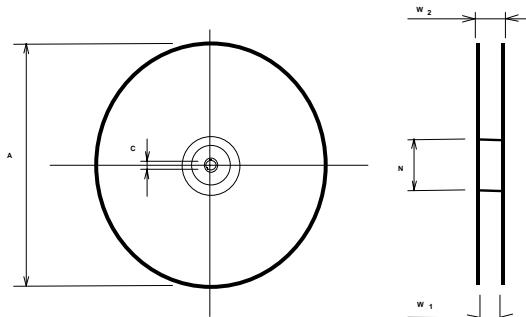

The minimum bending radius is 45 mm.

Tele Filter GmbH
Potsdamer Straße 18
D 14 513 TELTOW / Germany
Tel: (+49) 3328 4784-0 / Fax: (+49) 3328 4784-30
E-Mail: tft@telefilter.com

VI TELEFILTER reserves the right to make changes to the product(s) and/or information contained herein without notice. No liability is assumed as a result of their use or application. No rights under any patent accompany the sale of any such product(s) or information.

Air reflow temperature conditions

Conditions	Exposure
Average ramp-up rate (30°C to 217°C)	less than 3°C/second
> 100°C	between 300 and 600 seconds
> 150°C	between 240 and 500 seconds
> 217°C	between 30 and 150 seconds
Peak temperature	max. 260°C
Time within 5°C of actual peak temperature	between 10 and 30 seconds
Cool-down rate (Peak to 50°C)	less than 6°C/second
Time from 30°C to Peak temperature	no greater than 300 seconds

Chip-mount air reflow profile

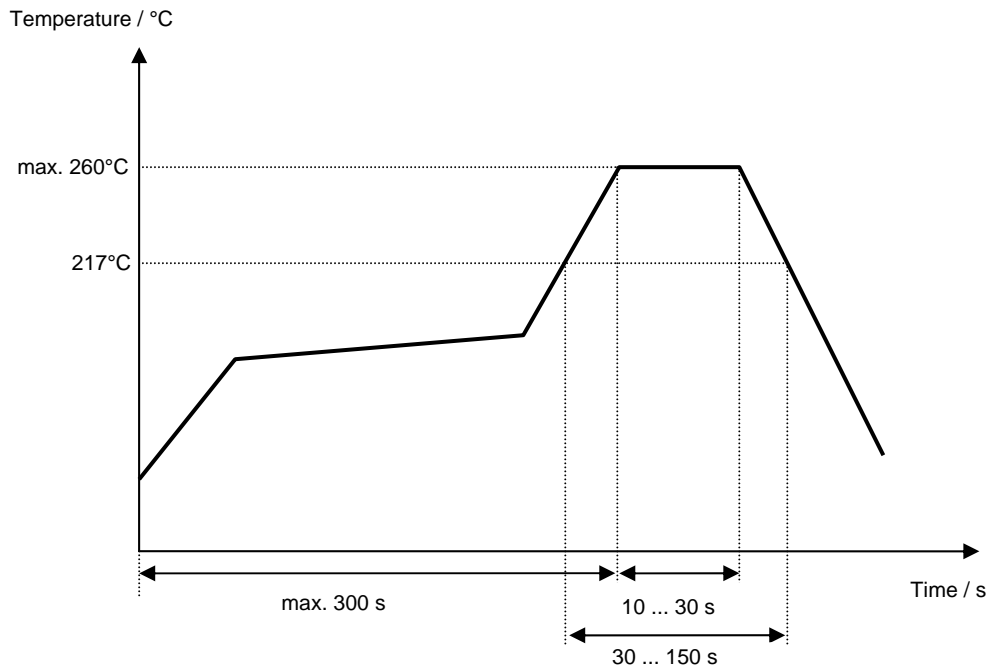

Tele Filter GmbH
Potsdamer Straße 18
D 14 513 TELTOW / Germany
Tel: (+49) 3328 4784-0 / Fax: (+49) 3328 4784-30
E-Mail: tft@telefilter.com

VI TELEFILTER reserves the right to make changes to the product(s) and/or information contained herein without notice. No liability is assumed as a result of their use or application. No rights under any patent accompany the sale of any such product(s) or information.

VI TELEFILTER**Filter specification****TFS 280G****5/5****History**

Version	Reason of Changes	Name	Date
1.0	- new generation	Steiner	20.08.2002
1.1	- change temperature, add 3dB passband requirement - relax stop-band limit lines according to larger temperature range	Steiner	28.10.2002
1.2	- source and load impedance added - passband magnitude extended to +/-20MHz - Tk added	Steiner	07.01.2003
1.3	- label changed to standard label	Steiner	18.03.2003
1.4	- change pinning corresponding to customer demands - added operating temperature range to guaranty for samples delivered with date code R16	Chilla	23.04.2003
1.5	- added limit line at 37 dB	Chilla	10.07.2003
1.6	- changed development specification to filter specification - added typical values - operating temperature range changed to -40 °C ... +80 °C - added terminating impedances	Chilla	16.10.2003
1.7	- filter characteristics added - test circuit updated - stability characteristics updated - air reflow temperature conditions updated	Chilla	03.03.2006

Tele Filter GmbH
Potsdamer Straße 18
D 14 513 TELTOW / Germany
Tel: (+49) 3328 4784-0 / Fax: (+49) 3328 4784-30
E-Mail: tft@telefilter.com

VI TELEFILTER reserves the right to make changes to the product(s) and/or information contained herein without notice. No liability is assumed as a result of their use or application. No rights under any patent accompany the sale of any such product(s) or information.