

JHC/JHW350 Series Power Modules; dc-dc Converter

18-36Vdc or 36-75Vdc Input; 28Vdc Output; 12.5A

RoHS Compliant



Applications

- Distributed power architectures
- Wireless Networks
- RF Amplifier

Options

- Positive Remote On/Off logic
- Auto restart after fault shutdown

Description

The JHC/JHW-series dc-dc converters are a new generation of DC/DC power modules designed for maximum efficiency and power density. The JHC/JHW series provide up to 350W output power in an industry standard Half-brick, which makes it an ideal choice for high voltage and high power applications. The converter incorporates synchronous rectification technology and innovative packaging techniques to achieve ultra high efficiency reaching 93.5% at 28V with full load. The 5-sided encapsulated case package allows for excellent thermal performance in strict thermal environment. Threaded-through holes are provided to allow easy mounting or addition of a heatsink for high-temperature applications. The JHC/JHW series power modules are isolated dc-dc converters that operate over a wide input voltage range of 18 to 36 Vdc or 36 to 75 Vdc respectively and provide single precisely regulated output. The output is fully isolated from the input, allowing versatile polarity configurations and grounding connections. Built-in filtering for both input and output minimizes the need for external filtering.

Features

- Compliant to RoHS EU Directive 2002/95/EC (-Z versions)
- Compliant to ROHS EU Directive 2002/95/EC with lead solder exemption (non-Z versions)
- High efficiency – 93.5% at 28V full load
- Industry standard pin-out
- Improved Thermal Performance: Full output power with case temperature (T_c) of 85°C
- High power density: 128 W/in³
- Low output ripple and noise
- Industry standard Half brick: 57.9 mm x 61.0 mm x 12.7 mm (2.28 in x 2.4 in x 0.5 in)
- Single tightly regulated output
- Remote sense
- 2:1 input voltage range
- Constant switching frequency
- Negative Remote On/Off logic
- Output over current/voltage protection
- Overtemperature protection
- Output voltage adjustment
- Wide operating temperature range (-40°C to 85°C)
- ISO** 9001 certified manufacturing facilities
- *UL*60950-1 Recognized, *CSA*[†] C22.2 No. 60950-1-03 Certified, and EN 60950-1 (*VDE*[‡] 0805): 2001-12 Licensed
- CE mark meets 73/23/EEC and 93/68/EEC directives[§] (JHW series only)

* *UL* is a registered trademark of Underwriters Laboratories, Inc.

[†] *CSA* is a registered trademark of Canadian Standards Association.

[‡] *VDE* is a trademark of Verband Deutscher Elektrotechniker e.V.

** *ISO* is a registered trademark of the International Organization of Standards

Absolute Maximum Ratings

Stresses in excess of the absolute maximum ratings can cause permanent damage to the device. These are absolute stress ratings only, functional operation of the device is not implied at these or any other conditions in excess of those given in the operations sections of the data sheet. Exposure to absolute maximum ratings for extended periods can adversely affect the device reliability.

Parameter	Device	Symbol	Min	Max	Unit
Input Voltage	JHC	V_{IN}	-0.3	40	Vdc
Continuous	JHW	V_{IN}	-0.3	80	Vdc
Transient (100ms)	JHC	$V_{IN,trans}$	-0.3	50	Vdc
Transient (100ms)	JHW	$V_{IN,trans}$	-0.3	100	Vdc
Operating Ambient Temperature (See Thermal Considerations section)	All	T_c	-40	100	°C
Storage Temperature	All	T_{stg}	-55	125	°C
I/O Isolation Voltage	All	—	—	1500	Vdc

Electrical Specifications

Unless otherwise indicated, specifications apply over all operating input voltage, resistive load, and temperature conditions.

Parameter	Device	Symbol	Min	Typ	Max	Unit
Operating Input Voltage	JHC	V_{IN}	18	24	36	Vdc
	JHW	V_{IN}	36	48	75	Vdc
Maximum Input Current	JHC	$I_{IN,max}$			23	Adc
($V_{IN}=0V$ to 36V, $I_O=I_{O,max}$)/($V_{IN}=0V$ to 75V, $I_O=I_{O,max}$)	JHW	$I_{IN,max}$			11	Adc
Inrush Transient	All	I^2t			2	A ² s
Input Reflected Ripple Current, peak-to-peak (5Hz to 20MHz, 12µH source impedance; $V_{IN}=0V$ to 75V, $I_O=I_{O,max}$; see Figure 13)	All			7	15	mAp-p
Input Ripple Rejection (120Hz)	All			60		dB

Fusing Considerations

CAUTION: This power module is not internally fused. An input line fuse must always be used.

This power module can be used in a wide variety of applications, ranging from simple standalone operation to an integrated part of a sophisticated power architecture. To preserve maximum flexibility, internal fusing is not included, however, to achieve maximum safety and system protection, always use an input line fuse. The safety agencies require a fast-acting fuse with a maximum rating of 20A for JHW series and 30A for JHC series(see Safety Considerations section). Based on the information provided in this data sheet on inrush energy and maximum dc input current, the same type of fuse with a lower rating can be used. Refer to the fuse manufacturer's data sheet for further information.

Electrical Specifications (continued)

Parameter	Device	Symbol	Min	Typ	Max	Unit
Output Voltage Set-point ($V_{IN}=V_{IN,nom}$, $I_O=I_{O,max}$, $T_c=25^\circ\text{C}$)	R	$V_{O,set}$	27.5	28	28.5	V _{dc}
Output Voltage (Over all operating input voltage, resistive load, and temperature conditions until end of life)	R	V_O	27.16	—	28.84	V _{dc}
Output Regulation Line ($V_{IN}=V_{IN,min}$ to $V_{IN,max}$) Load ($I_O=I_{O,min}$ to $I_{O,max}$) Temperature ($T_c = -40^\circ\text{C}$ to $+100^\circ\text{C}$)	All All All		— — —	0.02 0.05 100	0.1 0.2 300	%V _o %V _o mV
Output Ripple and Noise on nominal output ($V_{IN}=V_{IN,nom}$ and $I_O=I_{O,min}$ to $I_{O,max}$, $C_O=C_{O,min}$)						
RMS (5Hz to 20MHz bandwidth)	All		—	27	40	mV _{rms}
Peak-to-Peak (5Hz to 20MHz bandwidth)	All		—	45	150	mV _{pk-pk}
External Capacitance (type electrolytic)	All	$C_{O,max}$	1000	—	3600	μF
Output Current	R	I_O	0		12.5	Adc
Output Current Limit Inception	R	$I_{O,lim}$	—	13.5	—	Adc
Efficiency $V_{IN}=V_{IN,nom}$, $T_c=25^\circ\text{C}$ $I_O=I_{O,max}$, $V_O=V_{O,set}$	JHC350R JHW350R	η η	— —	92.5 93.5	— —	% %
Switching Frequency	All	f_{sw}	—	350	—	kHz
Dynamic Load Response ($\Delta I_O/\Delta t=1\text{A}/10\mu\text{s}$; $V_{in}=V_{in,nom}$; $T_c=25^\circ\text{C}$; Tested with a 330 μF aluminum and a 1.0 μF tantalum capacitor across the load.)						
Load Change from $I_O=50\%$ to 75% of $I_{O,max}$: Peak Deviation	All	V_{pk}	—	2	—	%V _{O,set}
Settling Time ($V_O<10\%$ peak deviation)	All	t_s	—	500	—	μs
Load Change from $I_O=75\%$ to 50% of $I_{O,max}$: Peak Deviation	All	V_{pk}	—	2	—	%V _{O,set}
Settling Time ($V_O<10\%$ peak deviation)	All	t_s	—	500	—	μs

Isolation Specifications

Parameter	Symbol	Min	Typ	Max	Unit
Isolation Capacitance	C_{iso}	—	440	—	pF
Isolation Resistance	R_{iso}	10	—	—	MΩ

General Specifications

Parameter	Device	Min	Typ	Max	Unit
Calculated MTBF ($I_o=80\%$ of $I_{o,max}$, $T_c=40^\circ\text{C}$, airflow=1m/s(200LFM))	All		2,179,312		Hours
Weight		—	112 (3.95)	—	g (oz.)

Feature Specifications

Unless otherwise indicated, specifications apply over all operating input voltage, resistive load, and temperature conditions. See Feature Descriptions for additional information.

Parameter	Device	Symbol	Min	Typ	Max	Unit
Remote On/Off Signal Interface ($V_{IN}=V_{IN, min}$ to $V_{IN, max}$; open collector or equivalent, Signal referenced to V_{IN-} terminal) Negative Logic: device code suffix "1" Logic Low = module On, Logic High = module Off Positive Logic: No device code suffix required Logic Low = module Off, Logic High = module On Logic Low Specification Remote On/Off Current – Logic Low	All	$I_{on/off}$	—	0.15	1.0	mA
On/Off Voltage: Logic Low	All	$V_{on/off}$	0.0	—	0.5	V
Logic High – (Typ = Open Collector)	All	$V_{on/off}$	—	—	5	V
Logic High maximum allowable leakage current	All	$I_{on/off}$	—	—	50	μ A
Turn-On Delay and Rise Times ($I_O=I_{O, max}$) T_{delay} = Time until $V_O = 10\%$ of $V_{O, set}$ from either application of V_{in} with Remote On/Off set to On or operation of Remote On/Off from Off to On with V_{in} already applied for at least one second. T_{rise} = time for V_O to rise from 10% of $V_{O, set}$ to 90% of $V_{O, set}$.	R	T_{delay}	—	40	—	ms
	All	T_{rise}	—	50	—	ms
Output Voltage Adjustment (See Feature Descriptions) Output Voltage Set-point Adjustment Range (trim)	All	V_{trim}	90	—	110	$\%V_{O, nom}$
Output Voltage Remote-sense Range (See Feature Descriptions)	All	V_{sense}	—	—	5	$\%V_{O, nom}$
Output Overvoltage Protection	R	$V_{O, limit}$	31	—	38	V
Overtemperature Protection (See Feature Descriptions)	All	T_{ref}	—	110	—	$^{\circ}$ C
Input Undervoltage Lockout		$V_{IN, UVLO}$				
Turn-on Threshold	JHC350R			17.5	18	V
Turn-off Threshold	JHC350R		15.5	16.5		V
Hysteresis	JHC350R			1		V
Turn-on Threshold	JHW350R		—	35	36	V
Turn-off Threshold	JHW350R		31	33	—	V
Hysteresis	JHW350R		---	2	---	V

Characteristic Curves

The following figures provide typical characteristics for the JHW350R (28V, 12.5A) at 25°C. The figures are identical for either positive or negative Remote On/Off logic.

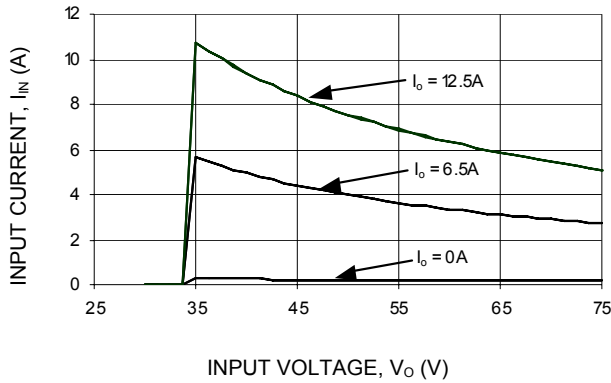

Figure 1. Typical Input Characteristic at Room Temperature.

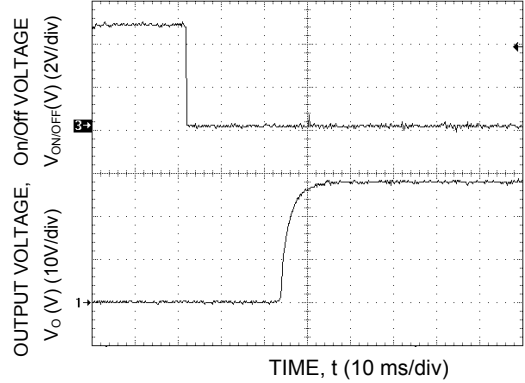

Figure 4. Typical Start-Up Using Remote On/Off, negative logic, $C_{o,ext} = 330\mu F$.

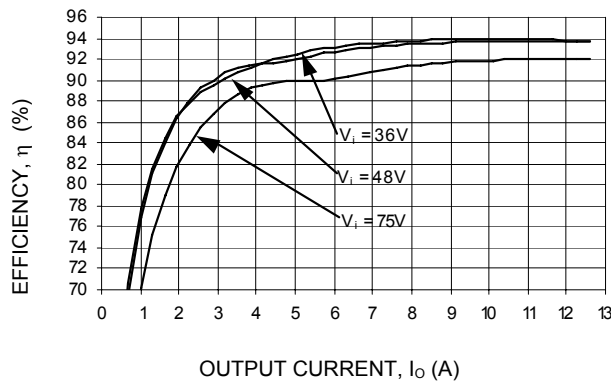

Figure 2. Typical Converter Efficiency Vs. Output current at Room Temperature.

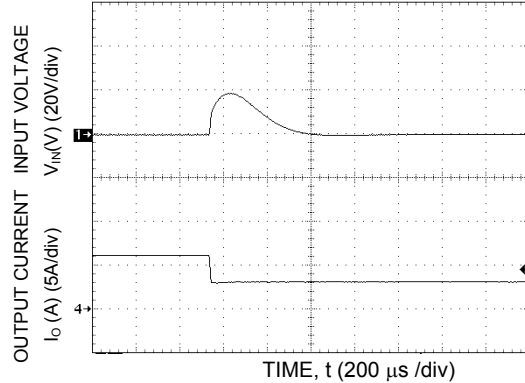

Figure 5. Typical Transient Response to Step Decrease in Load from 50% to 25% of Full Load at Room Temperature and 52 Vdc Input; $C_{o,ext} = 330\mu F$.

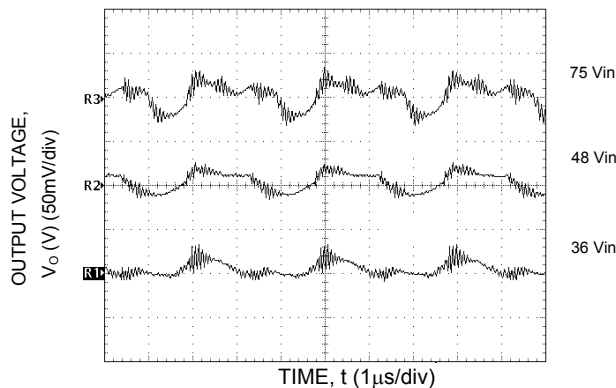

Figure 3. Typical Output Ripple and Noise at Room Temperature, $I_o = I_{o,max}$, $C_{o,ext} = C_{o,min} = 330\mu F$.

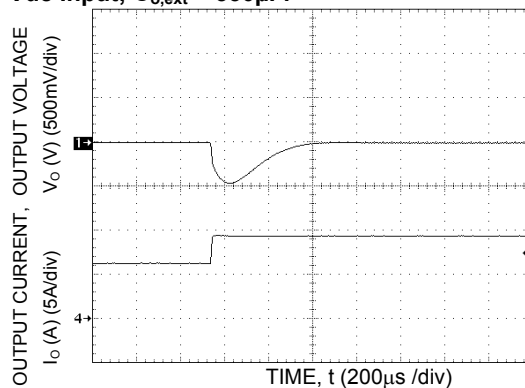

Figure 6. Typical Transient Response to Step Increase in Load from 50% to 75% of Full Load at Room Temperature and 52 Vdc Input; $C_{o,ext} = 330\mu F$.

Characteristic Curves

The following figures provide typical characteristics for the JHC350R (28V, 12.5A) at 25°C. The figures are identical for either positive or negative Remote On/Off logic.

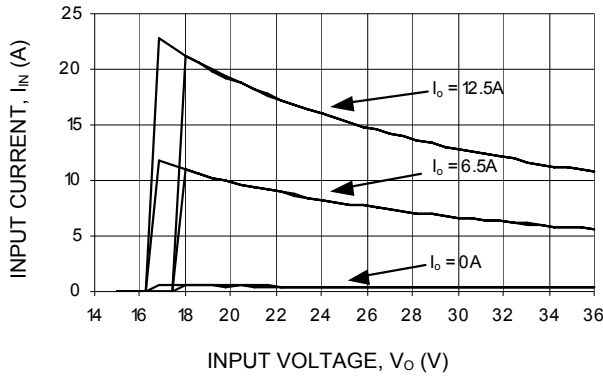

Figure 7. Typical Input Characteristic at Room Temperature.

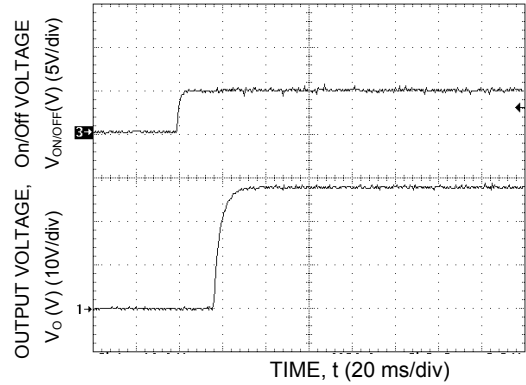

Figure 10. Typical Start-Up Using Remote On/Off, negative logic, $C_{o,ext} = 330\mu F$.

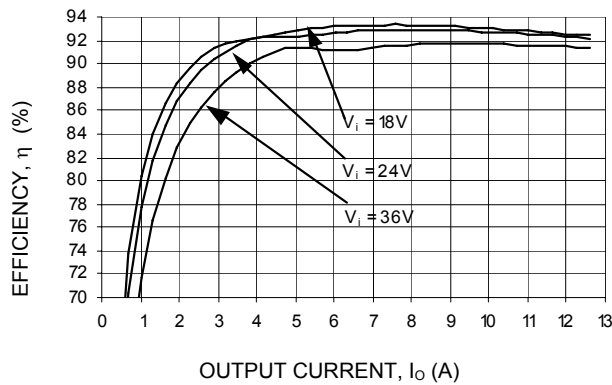

Figure 8. Typical Converter Efficiency Vs. Output current at Room Temperature.

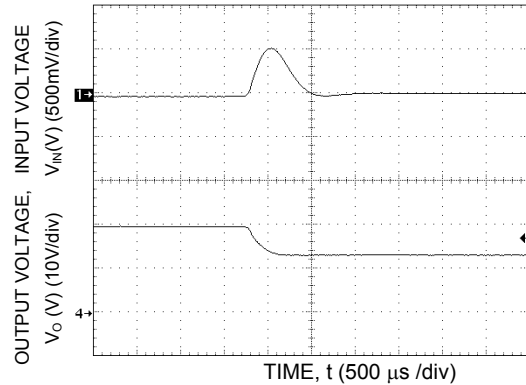

Figure 11. Typical Transient Response to Step Decrease in Load from 75% to 50% of Full Load at Room Temperature and 24 Vdc Input; $C_{o,ext} = 330\mu F$.

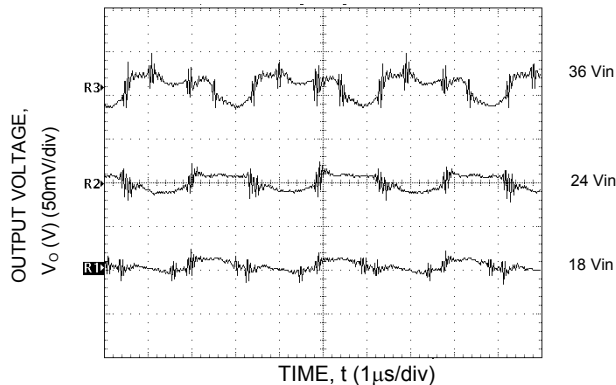

Figure 9. Typical Output Ripple and Noise at Room Temperature, $I_o = I_{o,max}$, $C_{o,ext} = C_{o,min} = 330\mu F$.

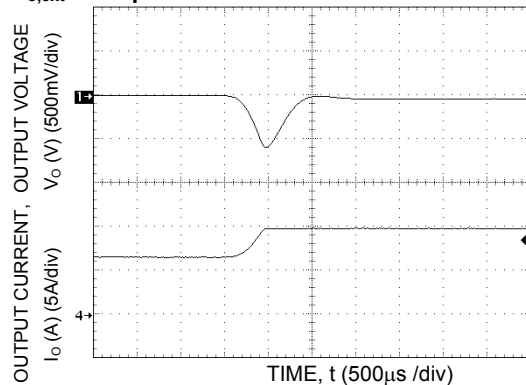
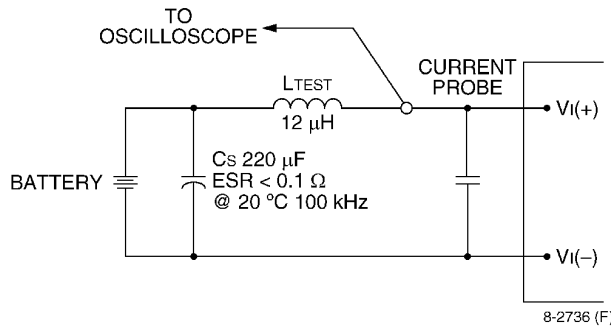

Figure 12. Typical Transient Response to Step Increase in Load from 50% to 75% of Full Load at Room Temperature and 24 Vdc Input; $C_{o,ext} = 330\mu F$.

Test Configurations



Note: Measure input reflected-ripple current with a simulated source inductance (LTEST) of 12 μH. Capacitor CS offsets possible battery impedance. Measure current as shown above.

Figure 13. Input Reflected Ripple Current Test Setup.

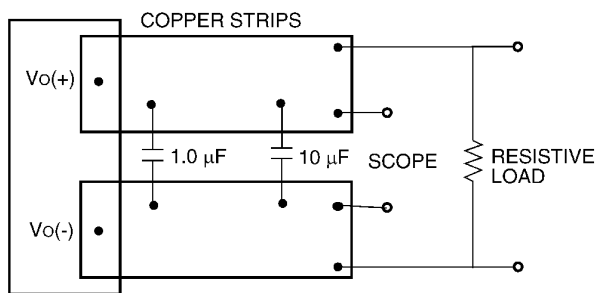

Note: Use a 1.0 μF ceramic capacitor and a 1000μF aluminum or tantalum capacitor. Scope measurement should be made using a BNC socket. Position the load between 51 mm and 76 mm (2 in. and 3 in.) from the module.

Figure 14. Output Ripple and Noise Test Setup.

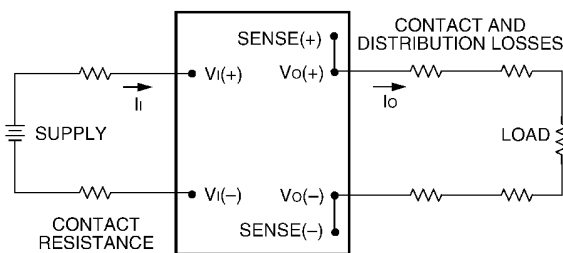

Note: All measurements are taken at the module terminals. When socketing, place Kelvin connections at module terminals to avoid measurement errors due to socket contact resistance.

$$\eta = \left(\frac{[V_O(+)-V_O(-)]I_O}{[V_I(+)-V_I(-)]I_I} \right) \times 100 \%$$

Figure 15. Output Voltage and Efficiency Test Setup.

Design Considerations

Input Source Impedance

The power module should be connected to a low ac-impedance source. Highly inductive source impedance can affect the stability of the power module. For the test configuration in Figure 13, a 200μF electrolytic capacitor (ESR<0.7Ω at 100kHz), mounted close to the power module helps ensure the stability of the unit. Consult the factory for further application guidelines.

Output Capacitance

Output capacitance and load impedance interact with the power module's output voltage regulation control system and may produce an 'unstable' output condition for the required values of capacitance and E.S.R.. Minimum and maximum values of output capacitance and of the capacitor's associated E.S.R. may be dictated, depending on the module's control system. This series power module requires minimum of 330μF output capacitance placed near output pins to ensure stable operation in full range of load/line conditions.

The process of determining the acceptable values of capacitance and E.S.R. is complex and is load-dependant. Lineage Power provides Web-based tools to assist the power module end-user in appraising and adjusting the effect of various load conditions and output capacitances on specific power modules for various load conditions.

Safety Considerations

All Versions - For safety-agency approval of the system in which the power module is used, the power module must be installed in compliance with the spacing and separation requirements of the end-use safety agency standard, i.e., UL60950, CSA C22.2 No. 60950-00, and EN 60950 (VDE 0805):2001-12.

“W” Versions only - For end products connected to – 48V dc, or –60Vdc nominal DC MAINS (i.e. central office dc battery plant), no further fault testing is required. *Note: -60V dc nominal battery plants are not available in the U.S. or Canada.

All Versions - For all input voltages, other than DC MAINS, where the input voltage is less than 60V dc, if the input meets all of the requirements for SELV, then:

- The output may be considered SELV. Output voltages will remain within SELV limits even with internally-generated non-SELV voltages. Single component failure and fault tests were performed in the power converters.
- One pole of the input and one pole of the output are to be grounded, or both circuits are to be kept floating, to maintain the output voltage to ground voltage within ELV or SELV limits.

“W” Versions only - For all input sources, other than DC MAINS, where the input voltage is between 60 and 75V dc (Classified as TNV-2 in Europe), the following must be met, if the converter’s output is to be evaluated for SELV:

- The input source is to be provided with reinforced insulation from any hazardous voltage, including the ac mains.
- One V_i pin and one V_o pin are to be reliably earthed, or both the input and output pins are to be kept floating.
- Another SELV reliability test is conducted on the whole system, as required by the safety agencies, on the combination of supply source and the subject module to verify that under a single fault, hazardous voltages do not appear at the module’s output.

All Versions - The power module has ELV (extra-low voltage) outputs when all inputs are ELV.

All flammable materials used in the manufacturing of these modules are rated 94V-0.

The input to these units is to be provided with a maximum 20A (JHW series) and 30A (JHC series)

fast-acting (or time-delay) fuse in the unearthed lead for their respective versions.

Feature Descriptions

Overcurrent Protection

To provide protection in a fault output overload condition, the module is equipped with internal current-limiting circuitry and can endure current limit for few seconds. If overcurrent persists for few seconds, the module will shut down and remain latch-off. The overcurrent latch is reset by either cycling the input power or by toggling the on/off pin for one second. If the output overload condition still exists when the module restarts, it will shut down again. This operation will continue indefinitely until the overcurrent condition is corrected.

An auto-restart option is also available.

Remote On/Off

Two remote on/off options are available. Positive logic remote on/off turns the module on during a logic-high voltage on the ON/OFF pin, and off during a logic low. Negative logic remote on/off turns the module off during a logic high and on during a logic low. Negative logic, device code suffix "1," is the factory-preferred configuration. To turn the power module on and off, the user must supply a switch to control the voltage between the on/off terminal ($V_{on/off}$) and the V_i (-) terminal. The switch can be an open collector or equivalent (see Figure 16). A logic low is $V_{on/off} = 0$ V to 0.5 V. The maximum $I_{on/off}$ during a logic low is 1 mA. The switch should maintain a logic-low voltage while sinking 1 mA. During a logic high, the maximum $V_{on/off}$ generated by the power module is 5 V. The maximum allowable leakage current of the switch at $V_{on/off} = 5$ V is 50 μ A. If not using the remote on/off feature, perform one of the following to turn the unit on:

For negative logic, short ON/OFF pin to $V_{IN}(-)$.

For positive logic: leave ON/OFF pin open.

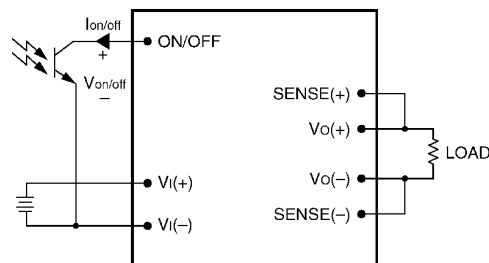

Figure 16. Remote On/Off Implementation.

8-720c

Feature Descriptions (continued)

Remote sense

Remote sense minimizes the effects of distribution losses by regulating the voltage at the remote-sense connections. The voltage between the remote-sense pins and the output terminals must not exceed the output voltage sense range given in the Feature Specifications table i.e.:

$$[V_o(+)-V_o(-)] - [\text{SENSE}(+) - \text{SENSE}(-)] \leq 5\% \text{ of } V_{o,nom}$$

The voltage between the Vo(+) and Vo(-) terminals must not exceed the minimum output overvoltage shut-down value indicated in the Feature Specifications table. This limit includes any increase in voltage due to remote-sense compensation and output voltage set-point adjustment (trim). See Figure 17. If not using the remote-sense feature to regulate the output at the point of load, then connect SENSE(+) to Vo(+) and SENSE(-) to Vo(-) at the module.

Although the output voltage can be increased by both the remote sense and by the trim, the maximum increase for the output voltage is not the sum of both. The maximum increase is the larger of either the remote sense or the trim. The amount of power delivered by the module is defined as the voltage at the output terminals multiplied by the output current. When using remote sense and trim: the output voltage of the module can be increased, which at the same output current would increase the power output of the module. Care should be taken to ensure that the maximum output power of the module remains at or below the maximum rated power.

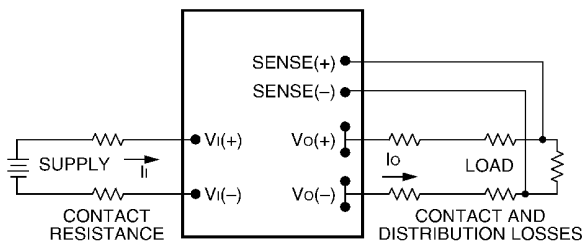

Figure 17. Effective Circuit Configuration for Single-Module Remote-Sense Operation Output Voltage.

Output Voltage Set-Point Adjustment (Trim)

Trimming allows the user to increase or decrease the output voltage set point of a module. This is accomplished by connecting an external resistor between the TRIM pin and either the SENSE(+) or SENSE(-) pins. The trim resistor should be positioned close to the module.

If not using the trim feature, leave the TRIM pin open.

With an external resistor between the TRIM and SENSE(-) pins (Radj-down), the output voltage set point (Vo,adj) decreases (see Figure 18). The following equation determines the required external-resistor value to obtain a percentage output voltage change of Δ%.

For output voltages: 28V

$$R_{adj-down} = \left(\frac{100}{\Delta\%} - 2 \right) K\Omega$$

Where,

$$\Delta\% = \left| \frac{V_{o,nom} - V_{desired}}{V_{o,nom}} \right| \times 100$$

V_{desired} = Desired output voltage set point (V).

With an external resistor connected between the TRIM and SENSE(+) pins (Radj-up), the output voltage set point (Vo,adj) increases (see Figure 19).

The following equation determines the required external-resistor value to obtain a percentage output voltage change of Δ%.

For output voltages: 28V

$$R_{adj-up} = \left(\frac{V_{o,nom} * (100 + \Delta\%)}{1.225 * \Delta\%} - \frac{(100 + 2\Delta\%)}{\Delta\%} \right) K\Omega$$

Where,

$$\Delta\% = \left| \frac{V_{desired} - V_{o,nom}}{V_{o,nom}} \right| \times 100$$

V_{desired} = Desired output voltage set point (V).

The voltage between the Vo(+) and Vo(-) terminals must not exceed the minimum output overvoltage shut-down value indicated in the Feature Specifications table. This limit includes any increase in voltage due to remote-sense compensation and output voltage set-point adjustment (trim). See Figure 17.

Although the output voltage can be increased by both the remote sense and by the trim, the maximum increase for the output voltage is not the sum of both. The maximum increase is the larger of either the remote sense or the trim.

The amount of power delivered by the module is defined as the voltage at the output terminals multiplied by the output current. When using remote sense and trim, the output voltage of the module can be increased, which at the same output current would increase the power output of the module. Care should be taken to ensure that the maximum output power of

Feature Descriptions (continued)

the module remains at or below the maximum rated power.

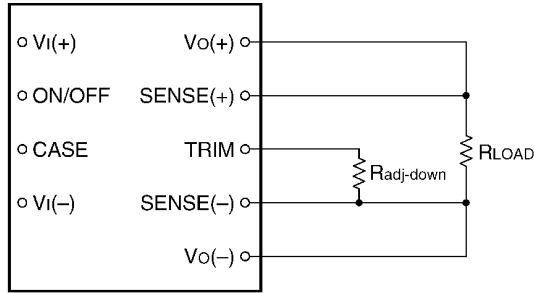

8-748 (F).b

Figure 18. Circuit Configuration to Decrease Output Voltage.

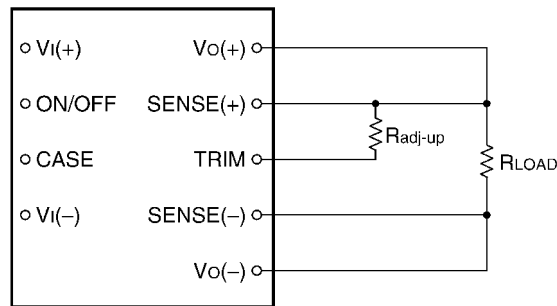

8-715 (F).b

Figure 19. Circuit Configuration to Increase Output Voltage.

Examples:

To trim down the output of a nominal 28V module (JHW350R) to 26.6V

$$\Delta\% = \left| \frac{28V - 26.6V}{28V} \right| \times 100$$

$$\Delta\% = 5$$

$$R_{adj-down} = \left(\frac{100}{5} - 2 \right) K\Omega$$

$$R_{adj-down} = 18 k\Omega$$

To trim up the output of a nominal 28V module (JHW350R) to 29.4V

$$\Delta\% = \left| \frac{28V - 29.4V}{28V} \right| \times 100$$

$$\Delta\% = 5$$

$$R_{adj-up} = \left(\frac{28 * (100 + 5)}{1.225 * 5} - \frac{(100 + 2 * 5)}{5} \right) K\Omega$$

$$R_{tadj-up} = 458k\Omega$$

Output Overvoltage Protection

The output overvoltage protection consists of circuitry that monitors the voltage on the output terminals. If the voltage on the output terminals exceeds the over voltage protection threshold, then the module will shutdown and latch off. The latch is reset by either cycling the input power for one second or by toggling the on/off signal for one second. The protection mechanism is such that the unit can continue in this condition until the fault is cleared.

Overtemperature Protection

These modules feature an overtemperature protection circuit to safeguard against thermal damage. The circuit shuts down the module when the maximum case reference temperature is exceeded. The module will restart automatically when the case temperature cools below the overtemperature shutdown threshold.

Input Undervoltage Lockout

At input voltages below the input undervoltage lockout limit, the module operation is disabled. The module will begin to operate at an input voltage above the undervoltage lockout turn-on threshold.

Thermal Considerations

The power modules operate in a variety of thermal environments; however, sufficient cooling should be provided to help ensure reliable operation of the unit. Heat-dissipating components inside the unit are thermally coupled to the case. Heat is removed by conduction, convection, and radiation to the surrounding environment. Proper cooling can be verified by measuring the case temperature. Peak temperature (T_C) occurs at the position indicated in Figure 20.

Considerations include ambient temperature, airflow, module power dissipation, and the need for increased reliability. A reduction in the operating temperature of the module will result in an increase in reliability. The thermal data presented here is based on physical measurements taken in a wind tunnel.

For reliable operation this temperature should not exceed 100°C threshold.

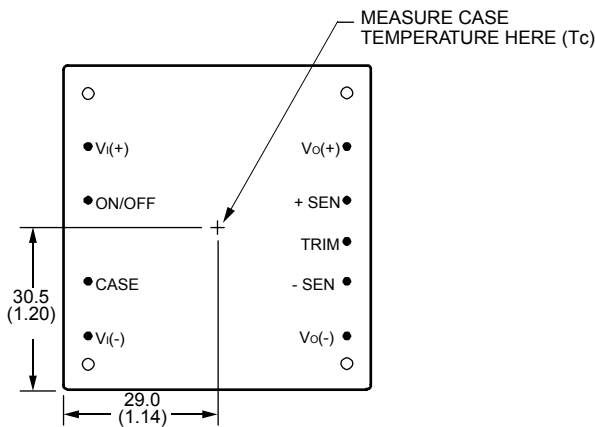

Figure 20. Metal Case (T_C) Temperature Measurement Location (top view).

The output power of the module should not exceed the rated power for the module as listed in the Ordering Information table.

Although the maximum T_C temperature of the power modules is 100 °C, you can limit this temperature to a lower value for extremely high reliability.

Please refer to the Application Note “Thermal Characterization Process For Open-Frame Board-Mounted Power Modules” for a detailed discussion of thermal aspects including maximum device temperatures.

Heat Transfer via Convection

Increased airflow over the module enhances the heat transfer via convection. Following derating figures shows the maximum output power that can be delivered by each module in the respective orientation without exceeding the maximum T_C temperature

versus local ambient temperature (T_A) for natural convection through 2m/s (400 ft./min).

Note that the natural convection condition was measured at 0.05 m/s to 0.1 m/s (10ft./min. to 20 ft./min.); however, systems in which these power modules may be used typically generate natural convection airflow rates of 0.3 m/s (60 ft./min.) due to other heat dissipating components in the system. The use of Figure 21 is shown in the following example:

Example

What is the minimum case temperature must be maintained to operate a JHW350R at $V_{in} = 48 V$, an output power of 300W in longitudinal orientation.

Solution:

Given: $V_I = 48V$

$P_o = 300W$

Determine case temperature (Use Figure 21):

$T_C = 92\text{ }^\circ\text{C}$

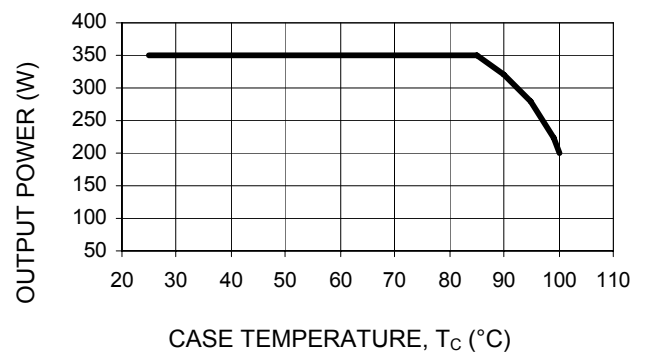

Figure 21. Output Power Derating for JHC/JHW350R ($V_o = 28V$) in Longitudinal Orientation; Airflow Direction From $V_{in}(-)$ to $V_{out}(-)$; $V_{in} = V_{in, nom}$

Layout Considerations

The JHC/JHW power module series are encapsulated aluminum case packaged style, as such; component clearance between the bottom of the power module and the mounting (Host) board is limited. Avoid placing copper areas on the outer layer directly underneath the power module. Also avoid placing via interconnects underneath the power module.

For additional layout guide-lines, refer to FLTR100V20 data sheet.

Post Solder Cleaning and Drying Considerations

Post solder cleaning is usually the final circuit-board assembly process prior to electrical board testing. The result of inadequate cleaning and drying can affect both the reliability of a power module and the testability of the finished circuit-board assembly. For guidance on appropriate soldering, cleaning and drying procedures, refer to *Lineage Power Board Mounted Power Modules: Soldering and Cleaning* Application Note (AP01-056EPS).

Through-Hole Lead-Free Soldering Information

The RoHS-compliant through-hole products use the SAC (Sn/Ag/Cu) Pb-free solder and RoHS-compliant components. They are designed to be processed through single or dual wave soldering machines. The pins have an RoHS-compliant finish that is compatible with both Pb and Pb-free wave soldering processes. A maximum preheat rate of 3°C/s is suggested. The wave preheat process should be such that the temperature of the power module board is kept below 210°C. For Pb solder, the recommended pot temperature is 260°C, while the Pb-free solder pot is 270°C max. Not all RoHS-compliant through-hole products can be processed with paste-through-hole Pb or Pb-free reflow process. If additional information is needed, please consult with your Lineage Power representative for more details.

Mechanical Outline for Through-hole Module

Dimensions are in millimeters and (inches).

Tolerances: x.x mm ± 0.5 mm (x.xx in. ± 0.02 in.) [unless otherwise indicated]

x.xx mm ± 0.25 mm (x.xxx in ± 0.010 in.)

TOP VIEW

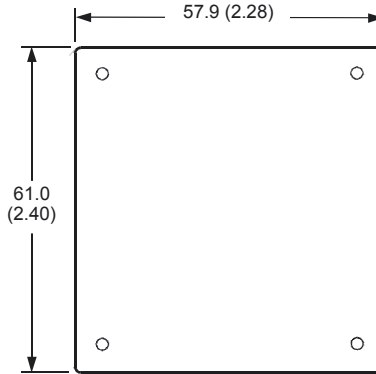

SIDE VIEW

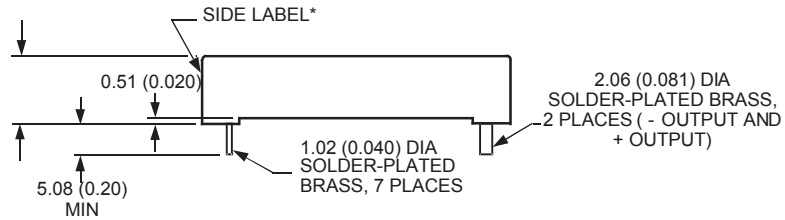

BOTTOM VIEW

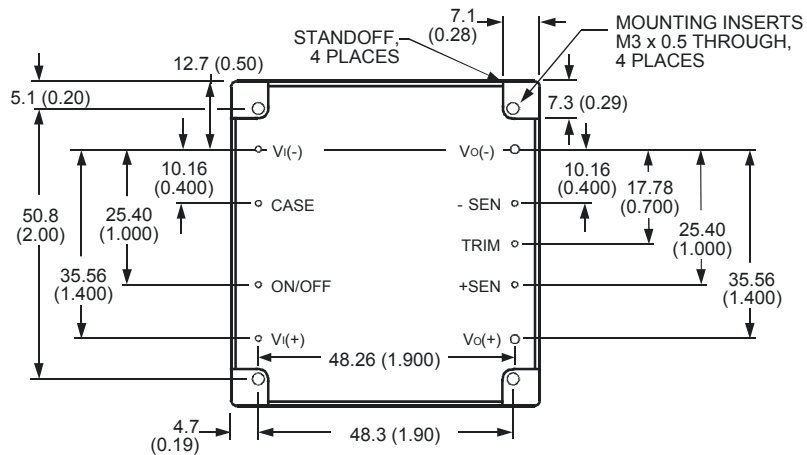

*Side label includes Lineage Power name, product designation, and data code.

Option Feature, Pin is not present unless one these options specified

Recommended Pad Layout for Through-Hole Modules

Dimensions are in millimeters and (inches).

Tolerances: x.x mm ± 0.5 mm (x.xx in. ± 0.02 in.) [unless otherwise indicated]

x.xx mm ± 0.25 mm (x.xxx in ± 0.010 in.)

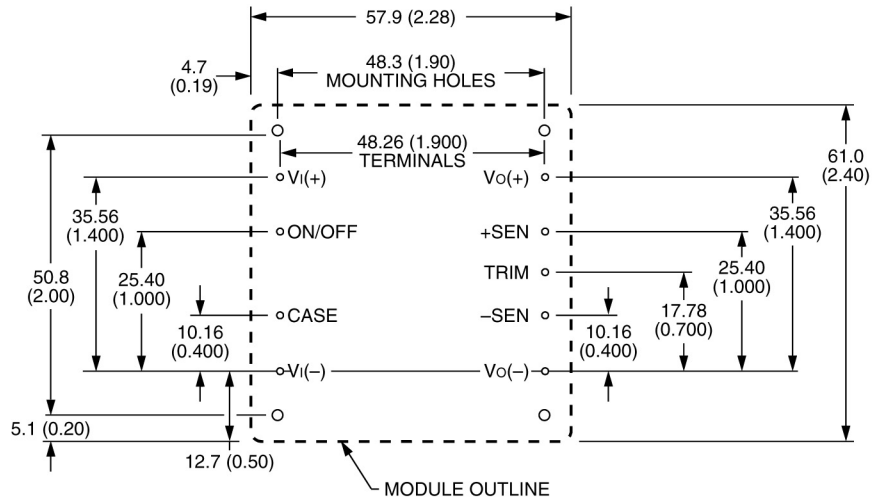

Ordering Information

Please contact your Lineage Power Sales Representative for pricing, availability and optional features.

Table 1. Device Codes

Input Voltage	Output Voltage	Output Current	Efficiency	Connector Type	Product codes	Comcodes
48V (36-75Vdc)	28V	12.5A	93.5%	Through hole	JHW350R1	108980749
48V (36-75Vdc)	28V	12.5A	93.5%	Through hole	JHW350R41	108986548
48V (36-75Vdc)	28V	12.5A	93.5%	Through hole	JHW350R41Z	CC109129276
24V (18-36Vdc)	28V	12.5A	92.5%	Through hole	JHC350R4	108987462
24V (18-36Vdc)	28V	12.5A	92.5%	Through hole	JHC350R41	108991634
24V (18-36Vdc)	28V	12.5A	92.5%	Through hole	JHC350R4Z	CC109129268

Table 2. Device Options

Option	Suffix
Negative remote on/off logic	1
Auto-restart	4
Unthreaded heatsink mounting holes	18
RoHS Compliant	Z



LINEAGE POWER

World Wide Headquarters
Lineage Power Corporation
 3000 Skyline Drive, Mesquite, TX 75149, USA
+1-800-526-7819
 (Outside U.S.A.: **+1-972-284-2626**)
www.lineagepower.com
e-mail: techsupport1@lineagepower.com

Asia-Pacific Headquarters
 Tel: +65 6416 4283

Europe, Middle-East and Africa Headquarters
 Tel: +49 89 6089 286

India Headquarters
 Tel: +91 80 28411633

Lineage Power reserves the right to make changes to the product(s) or information contained herein without notice. No liability is assumed as a result of their use or application. No rights under any patent accompany the sale of any such product(s) or information.

© 2008 Lineage Power Corporation, (Mesquite, Texas) All International Rights Reserved.