

SG6105A

Power Supply Supervisor + Regulator + PWM

Features

- PC Half-Bridge (or 494) Power Supply Supervisor + two 431 + PWM
- High Integration with Few External Components
- Over-Voltage Protection for 3.3V, 5V, and 12V
- Under-Voltage Protection for 3.3V, 5V, and 12V
- Under-Voltage Protection for -12V and/or -5V
- Over-Power and Short-Circuit Protection
- Power-Down Warning Circuitry
- Power-Good Circuitry
- Delay Time for PSON and PG Signal
- Remote ON/OFF Function
- On-Chip Oscillator and Error Amplifier
- Two Shunt Regulators for 3.3V and 5V-Standby
- Latching PWM for Cycle-by-Cycle Switching
- Push-Pull PWM Operation and Totem Pole Outputs
- Soft-Start and Maximum 93% Duty Cycle

Description

SG6105A controller is designed for switching-mode power supplies for desktop PCs. It provides all the functions necessary to monitor and control the output of the power supply. Remote ON/OFF control, power-good circuitry, and protection features against over-voltage and over-power are implemented. It directly senses all the output rails for OVP without the need for external dividers. An innovative AC-signal sampling circuitry provides a sufficient power-down warning signal for PG.

A built-in timer generates accurate timing for the control circuit, including the PS-off delay. The cycle-by-cycle PWM switching prevents the power transformer from saturation and ensures the fastest response for the short-circuit protection, which greatly reduces stress for power transistors. Two internal precision TL431 shunt regulators provide stable reference voltage and a driver for 3.3V and 5V standby regulation.

Utilizing minimum external components, the SG6105A includes the functions for push-pull and/or half-bridge topology, decreasing production cost and PCB space, and increasing the MTBF for power supply.

Applications

Switching mode power supply for computers:

- AT
- NLX
- SFX (micro-ATX)

Ordering Information

Part Number	Operating Temperature Range	 Eco Status	Package	Packing Method
SG6105ADZ	-40 to +105°C	RoHS	20-pin Dual In-Line Package (DIP)	Tube
SG6105ADY	-40 to +105°C	Green	20-pin Dual In-Line Package (DIP)	Tube

 For Fairchild's definition of Eco Status, please visit: http://www.fairchildsemi.com/company/green/rohs_green.html.

Application Diagram

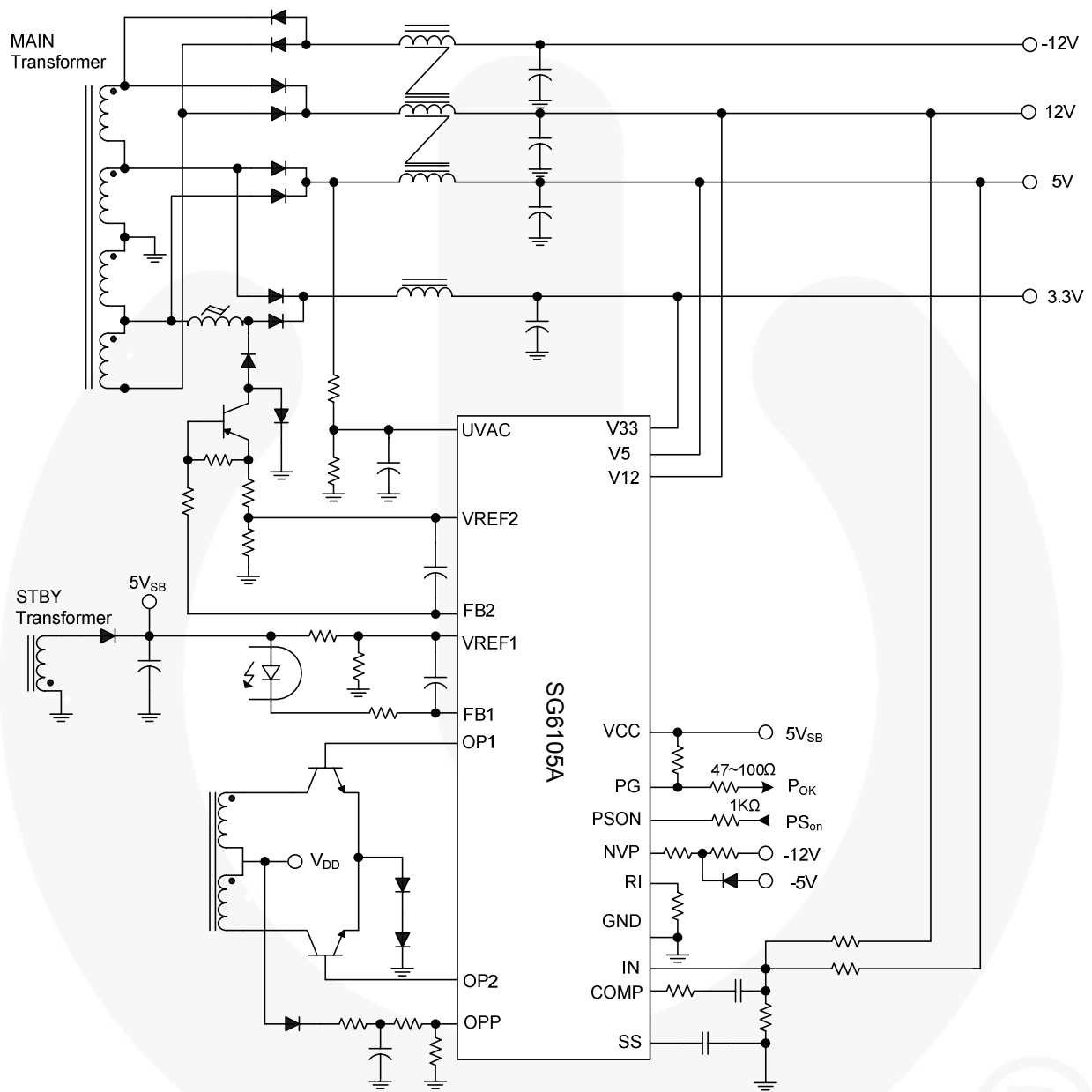

Figure 1. Typical Application

Block Diagram

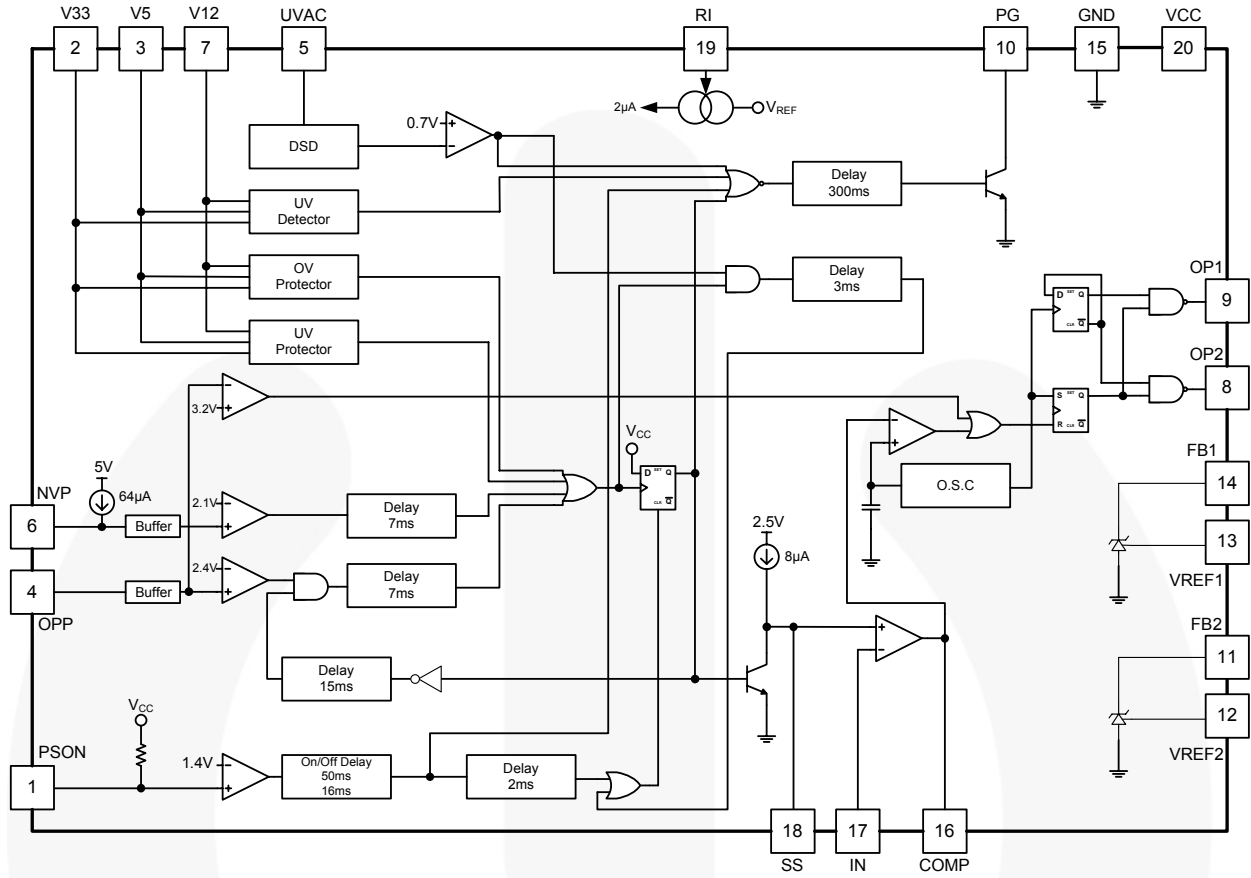
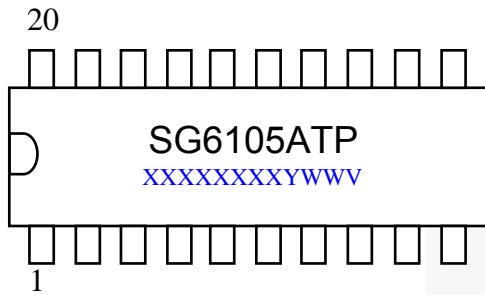

Figure 2. Function Block Diagram

Marking Information



T : D = DIP
 P : Z = Lead Free
 Null=Regular Ppackage
 XXXXXXXX: Wafer Lot
 Y: Year; WW: Week
 V: Assembly Location

※Marking for SG6105ADZ (Pb-free)

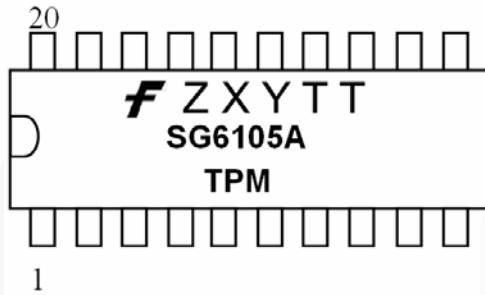

F- Fairchild Logo
 Z- Plant Code
 X- 1 Digit Year Code
 Y- 1 Digit Week Code
 TT: 2 Digits Die Run Code
 T: Package Type (D=DIP)
 P: Y:Green Package
 M: Manufacture Flow Code

※Marking for SG6105ADY(Green compound)

Figure 3. Top Mark

Pin Configuration

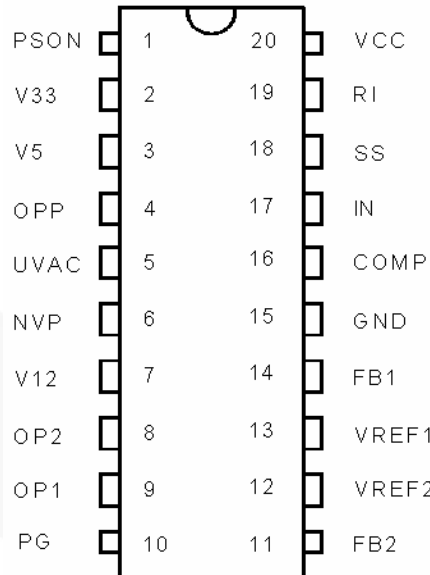

Figure 4. Pin Configuration (Top View)

Pin Definitions

Pin #	Name	Description
1	PSON	Remote on/off logic input for CPU or controller. Turn on/off the PWM output after the 7.5ms / 26ms delay. PSON=0, the main SMPS is operational. PSON =1, the main SMPS is off and the latch is reset.
2	V33	3.3V over-voltage/under-voltage control sense input.
3	V5	5V over-voltage/under-voltage control sense input.
4	OPP	Over-power sense input. This pin is connected to driver transformer or the output of current transformer. When not in use, this pin should be grounded.
5	UVAC	AC fail detection. Detect main AC voltage under-voltage and/or failure.
6	NVP	The protection input for negative output, such as -12V and/or -5V. Trip voltage=2.1V.
7	V12	12V over-voltage/under-voltage control sense input.
9/8	OP1/OP2	The totem-pole output drivers of push-pull PWM. The outputs are enabled (LOW) only when the NAND gate inputs are HIGH. The maximum duty cycle on an output (OP1 or OP2) is 46%.
10	PG	Power-good logic output, 0 or 1 (open-collector). PG=1, the power is good for operation. The PG delay is 300ms.
11	FB2	Output for second converter regulation loop.
12	VREF2	Reference comparison input for second converter regulation loop, 2.5V.
13	VREF1	Reference comparison input for first converter regulation loop, 2.5V.
14	FB1	Output for first converter regulation loop.
15	GND	Ground.
16	COMP	Error amplifier output and the input of the PWM comparator.
17	IN	The negative input of error amplifier. The positive input of error amplifier is a 2.5V reference voltage.
18	SS	Soft-start, settable through an external capacitor. The current source output at this pin is 8 μ A and the voltage is clamped at 2.5V.
19	RI	Connected to external resistor for the reference setting. R _I =75k Ω .
20	VCC	Supply voltage. 4.5V ~ 5.5V connected to 5V-standby.

Absolute Maximum Ratings

Stresses exceeding the absolute maximum ratings may damage the device. The device may not function or be operable above the recommended operating conditions and stressing the parts to these levels is not recommended. In addition, extended exposure to stresses above the recommended operating conditions may affect device reliability. The absolute maximum ratings are stress ratings only.

Symbol	Parameter	Min.	Max.	Unit
V _{CC}	DC Supply Voltage at Pin 20		16	V
I _{OUT}	Output Current at PG, Fb1, Fb2 Pins		30	mA
VPIN	V12, OP1, OP2, FB1, FB2, SS	-0.3	16.0	V
	PSON, V33, V5, VREF1, VREF2, OPP, UVAC, RI, NVP, IN, COMP, PG	-0.3	7.0	V
P _D	Power Dissipation	(T _A =25°C)	1.5	W
		(T _A =90°C)	0.5	
T _{STG}	Storage Temperature Range	-55	+150	°C
θ _{JA}	Thermal Resistance, Junction-To-Air		82.5	°C/W
T _J	Operating Junction Temperature		+150	°C
T _A	Operating Ambient Temperature	-30	+125	°C
T _L	Lead Temperature (Soldering, 10 Seconds)		+260	°C
ESD	Human Body Model, JESD22-A114		3	KV

Notes:

- All voltage values, except differential voltages, are given with respect to GND pin.
- Stresses beyond those listed under "absolute maximum ratings" may cause permanent damage to the device.

Recommended Operating Conditions

The Recommended Operating Conditions table defines the conditions for actual device operation. Recommended operating conditions are specified to ensure optimal performance to the datasheet specifications. Fairchild does not recommend exceeding them or designing to Absolute Maximum Ratings.

Symbol	Parameter	Min.	Max.	Unit
T _A	Operating Ambient Temperature Range	-40	+105	°C

Electrical Characteristics

$V_{CC}=5V$, $T_A=25^\circ C$, $R_i=75K\Omega$, unless noted operating specs.

Symbol	Parameter	Conditions	Min.	Typ.	Max.	Units
I_{CC}	Total Supply Current	PG High		5	10	mA
V_{OVP}	Over-Voltage Protection	3.3V	3.9	4.1	4.3	V
		5.0V	5.8	6.1	6.5	
		12.0V	13.9	14.5	14.9	
V_{UVP}	Under-Voltage Protection	3.3V	2.0	2.6	2.8	V
		5.0V	3.0	3.6	3.9	
		12.0V	6.0	7.2	8.0	
V_{UVS}	Under-Voltage Sense for PG Low	3.3V	2.5	2.8	3.0	V
		5.0V	4.0	4.3	4.5	
		12.0V	9.4	10.1	10.4	
V_{OPP}	Over-Power Protection (With T_{OPP} Delay Time) ⁽³⁾	$V_{UVAC}=1.5V$	2.25	2.32	2.39	V
V_{OPPH}	Over-Power Protection (Without Delay Time)		3.0	3.2	3.4	V
V_X	Disable Under-Voltage / Over-Power Protection Threshold		0.2	0.3	0.4	V
V_{NVP}	Negative Voltage Protection: Voltage Level		2.0	2.1	2.2	V
I_{NVP}	Negative Voltage Protection: Source Current		63	67	71	μA
T_{OVP}	Timing for Over-Voltage Protection		0.37	0.70	1.35	ms
T_{UVP}	Timing for Under-Voltage Protection		0.80	2.40	3.75	ms
T_{UVS}	Timing for Under-Voltage Sense for PG Low		0.37	1.20	1.88	ms
T_{OPP}	Timing for Over-Power Protection		5	7	9	ms
T_{NVP}	Timing for Negative Voltage Protection		3.3	7.0	10.2	Ms
Shunt Regulator Section Current						
V_{REF}	Reference Voltage	$I_{FB}=0.5mA$, $T_A=25^\circ C$	2.475	2.500	2.525	V
$V_{DEV, I}$	Deviation of V_{REF} Over FB Current ⁽⁴⁾	$I_{FB}=0.5mA$ to $10mA$			20	mV
$V_{DEV, T}$	Deviation of V_{REF} Over Temperature ⁽⁴⁾			10	30	mV
$R_{EGLI-FB}$	Line Regulation ⁽⁴⁾	$4 \leq V_{FB} \leq 15V$		1		mV/V
I_{OUT-FB}^{**}	Output Sinking Current Capability ⁽⁴⁾	$V_{FB}=2V$	10			mA

Notes:

- $V_{OPPS}=(2/3) \times V_{OPP} + (1/3) \times V_{UVAC}$.
- Not tested in production.

Continued on following page...

Electrical Characteristics (Continued)V_{CC}=5V, T_A= 25°C, R_I=75KΩ, unless noted operating specs.

Symbol	Parameter	Conditions	Min.	Typ.	Max.	Units
Power-Good Section						
T _{PG}	Timing for PG Delay	R _I =75kΩ	200	300	400	ms
V _{UVAC}	U _{VAC} Voltage Sense for PG		0.68	0.70	0.72	V
T _R	Power-Good Output Rising Time ⁽⁵⁾	C _L =100pF, Pull 2.2K to 5V		1	3	μs
T _F	Power-Good Falling Time ⁽⁵⁾	C _L =100pF, Pull 2.2K to 5V		300	500	ns
V _{OL2}	Power-Good Output Saturation Level	I _{PG} =5mA			0.5	V
I _{ON2}	Power-Good Leakage Current Collector	V _{PG} =5V			1	μA
Remote On/Off Section						
V _{IH}	High-Level Input Voltage		2			V
V _{IL}	Low-Level Input Voltage				0.8	V
V _{HYSTERESIS}	PSON Input Hysteresis Voltage		0.3			V
I _{PSON}	Remote Input Driving Current				0.5	mA
T _{PSON(ON)}	Timing PSON to On	R _I =75kΩ	38	50	62	ms
T _{PSON(OFF)}	Timing PSON to Off (PS-off)	R _I =75kΩ	8	16	24	ms
T _{PSOFF}	Timing PG Low to Power Off	R _I =75kΩ	1.5	2.0	6.3	ms
Error Amplifier Section						
V _{2.5}	Reference Voltage	T _A =25°C	2.46	2.50	2.54	V
I _{IB}	Input Bias Current ⁽⁵⁾				0.1	μA
A _{VOL}	Open-Loop Voltage Gain ⁽⁵⁾		50	60		dB
BW	Unity Gain Bandwidth ⁽⁵⁾		0.3	1.0		MHz
PSRR	Power Supply Rejection Ratio ⁽⁵⁾		50			dB
Oscillator Section						
f _{OSC}	PWM Frequency	R _I =75kΩ	62	65	68	KHz
Soft-Start Section						
I _{SS}	Charge Current		7	8	9	μA
Comparator Section						
DC	Duty Cycle		85		93	%
PWM Output Section						
V _{OL}	Output Voltage Low	I _O =20mA			0.8	V
V _{OH}	Output Voltage High	V _{I2} =12V	4			V
R _O	Output Impedance of V _{OH}		1.5		3.3	KΩ

Note:

5. Not tested in production.

Typical Performance Characteristics

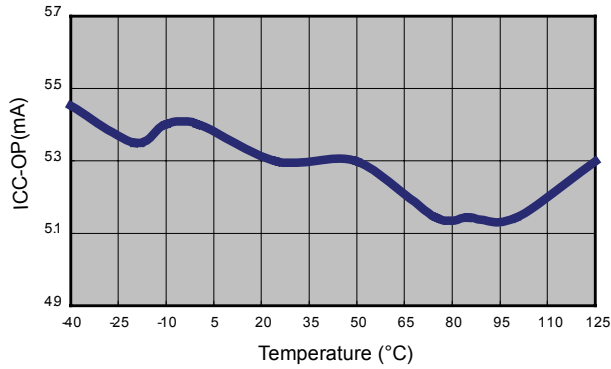

Figure 5. Operating Supply Current vs. Temperature

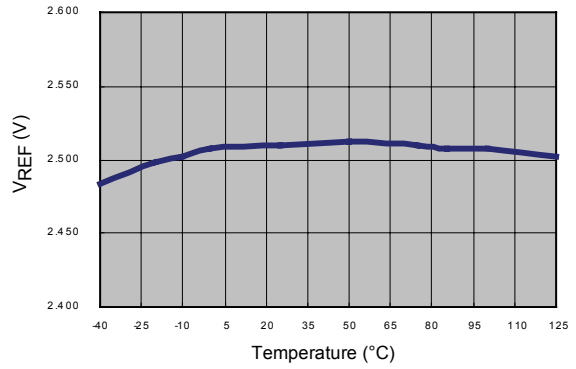

Figure 6. Reference Voltage vs. Temperature

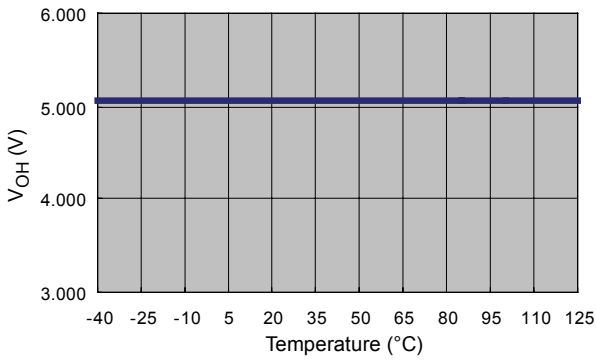

Figure 7. PWM Output Voltage vs. Temperature

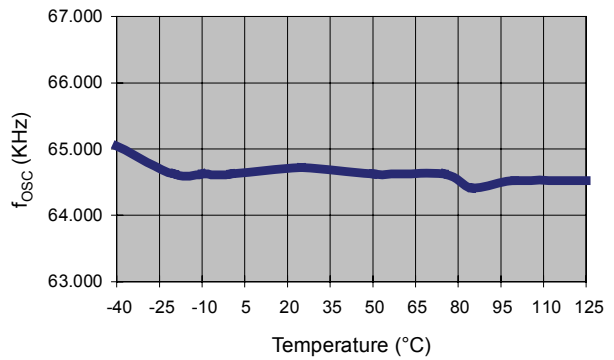

Figure 8. Frequency vs. Temperature

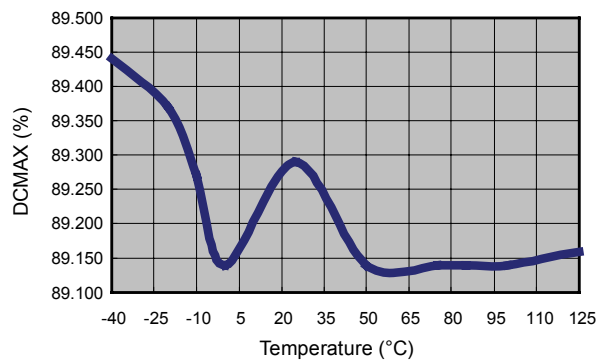

Figure 9. MAX Duty Cycle vs. Temperature

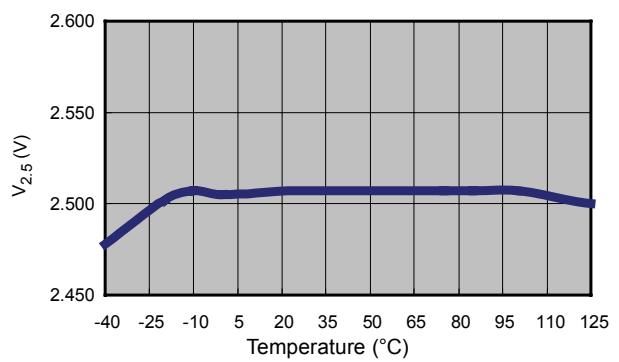

Figure 10. Reference Voltage vs. Temperature

Typical Performance Characteristics (Continued)

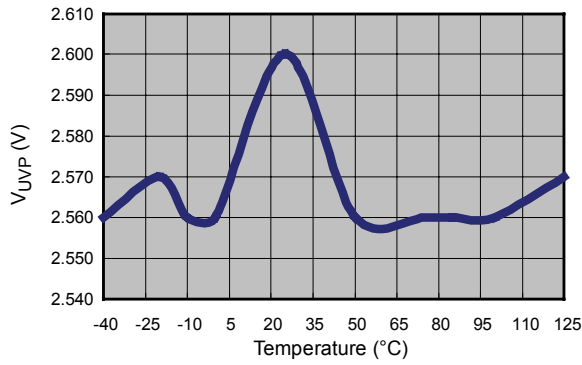

Figure 11. 3.3V V_{UVP} vs. Temperature

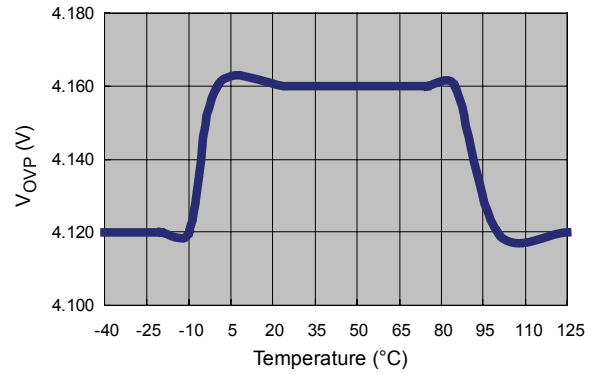

Figure 12. 3.3V V_{OVP} vs. Temperature

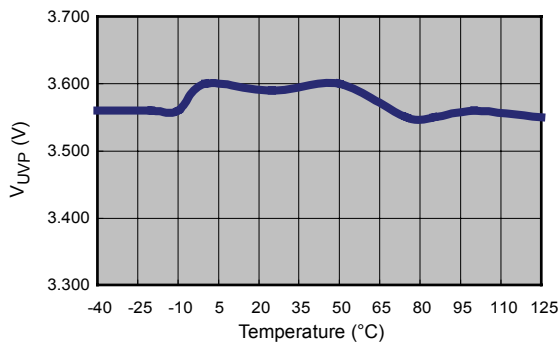

Figure 13. 5V V_{UVP} vs. Temperature

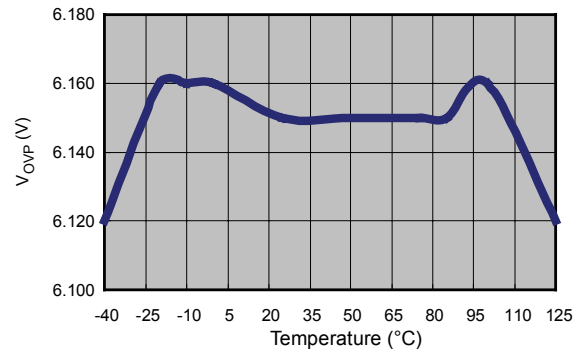

Figure 14. 5V V_{OVP} vs. Temperature

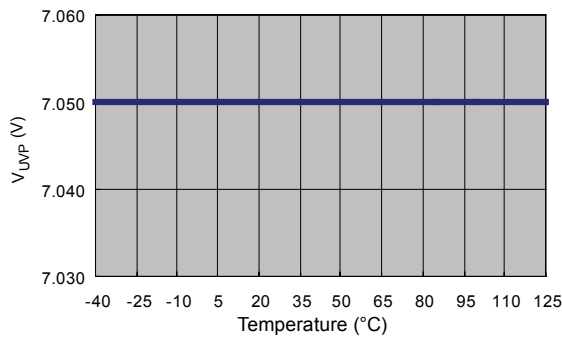

Figure 15. 12V V_{UVP} vs. Temperature

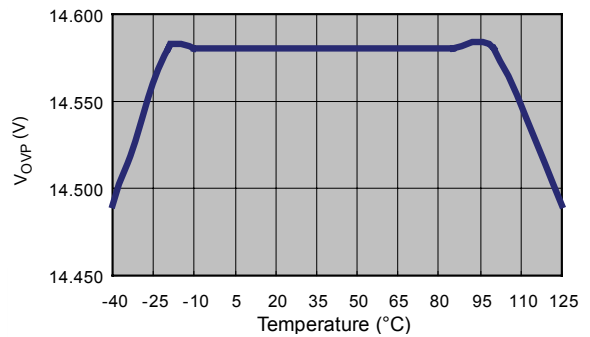

Figure 16. 12V V_{OVP} vs. Temperature

Functional Description

Protection against over-voltage, short-circuit, and fault conditions is mandatory in PC power supplies. These protection circuits can be realized by using many discrete components and comparators, which occupy a lot of PCB space and add to assembling costs. This single chip controller IC provides complete protection circuits, shunt regulators, and PWM control function with fewer components. SG6105A is an ideal controller IC for PC switching mode power supplies.

The features and benefits of this device are:

1. Over-voltage and under-voltage protection for 3.3V, 5V, and 12V without external divider.
2. Over-power protection.
3. UV protection for -12V and/or -5V.
4. Power-down warning for power-good signal.
5. Power-good signal and power-fail lockup.
6. Remote on/off control.
7. Delay time for PSON and PS-off signal.
8. Two shunt regulators for 3.3V and 5V-standby regulation.
9. Complete pulse width modulation (PWM) control circuitry.
10. On-chip oscillator.
11. Programmable soft-start.
12. Maximum 93% duty cycle.
13. Few external components.
14. More reliable system.
15. Little space on PCB.
16. Easy trouble-shooting and implementation.

Feature Descriptions

1. Over-voltage protection can be implemented without any additional components. Over-voltage sense levels for 3.3V, 5V, 12V, are 4.1V, 6.1V, 14.5V, respectively.
2. Over-current and/or short-circuit protection can also be achieved using over-power protection, in which the OPP pin is connected to the current transformer (driver transformer).
3. The power-good signal is asserted to indicate the 3.3V, 5V, and 12V is above the under-voltage threshold level. PG pin goes high when the above condition is reached. A 2K pull-up resistor may connect to 5V.
4. The V_{CC} can be supplied from the 5V-standby.
5. When the V_{CC} voltage is higher than 7V, besides the shunt regulator, the circuit is shutdown and reset. No extra power supply is needed.
6. Two internal high-precision 431 shunt regulators are built-in to provide stable reference voltages.
7. Complete PWM control circuitry, including the error amplifier for push-pull or half-bridge operation.

Supervisory Circuit Operation

The PC generates the remote ON/OFF logic (PSON), which is LOW for power supply on and HIGH to switch off the power supply. The remote ON/OFF is connected to PSON input.

Application Information

Introduction

The application guide shows the key features of SG6105A and illustrates how to design in an ATX switching mode power supply (SMPS). SG6105A is suitable for half-bridge, push-pull topology and incorporates with a four-channel supervisor, including 5V-standby. The PWM section of SG6105A comprises a built-in 65kHz oscillator and high-immunity circuits, which protect the system from noise interference and provide more noise margins for improper PCB layout. SG6105A has OVP and UVP for 12V, 5V, and 3.3V. NVP is used for negative voltage protection, such as -12V and/or -5V. The U_{VAC} (AC fails detection) is applied to detect AC line condition. Two built-in internal precision TL431 shunt regulators can be used for 3.3V or 5V auxiliary standby power.

AC Fails Detection

Through a resistor divider, U_{VAC} is connected to the secondary power transformer for detecting the AC line condition. Once the voltage of U_{VAC} is lower than 0.7V for a period of time, such as 200 μ s, the PG (power-good) signal is pulled low to indicate an AC line power-down condition. The voltage amplitude of the PWM switching signal in the secondary power transformer is proportional to the AC line voltage. Adjust the ratio of resistor divider to decide the threshold of power-down warning. A small capacitor is connected from U_{VAC} to ground for filtering the switching noise.

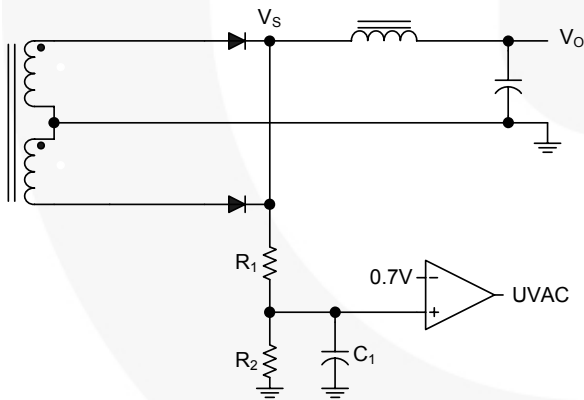

Figure 17. AC Detection Circuit

Over-Power Protection (OPP)

The OPP is used for detecting over-power and/or short-circuit conditions. When OPPS voltage (p.4, Note-1) is higher than 2.1V and this situation exists for longer than 7ms, SG6105A pulls the PG low and locks off the power outputs.

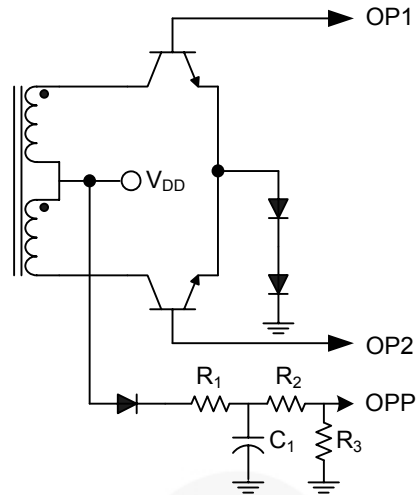

Figure 18. OPP Protection Circuit

Negative Voltage Protection (NVP)

The NVP provides an under-voltage protection (UVP) for negative voltage outputs. An under-voltage represents the phenomenal of the overload condition in negative voltage output. For example, the -12V output may drop to -10V during the overload situation. A resistor determining the threshold of the protection is connected from pin NVP to the negative voltage output. Via this resistor, NVP outputs a 64 μ A constant current to the negative voltage output. When the NVP voltage is over 2.1V and the situation kept for longer than 7ms, SG6105A locks the power outputs off:

$$V_{NVP} = 64\mu A \times (R1 + R2) - V_{-12V} \quad (1)$$

The power outputs are locked off when $V_{NVP} \geq 2.1V$.

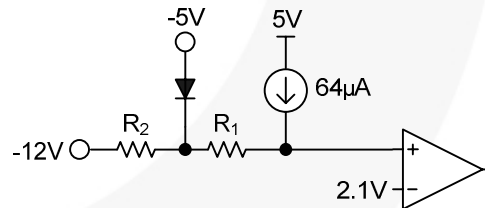

Figure 19. NVP Protection Circuit

Timing Diagram

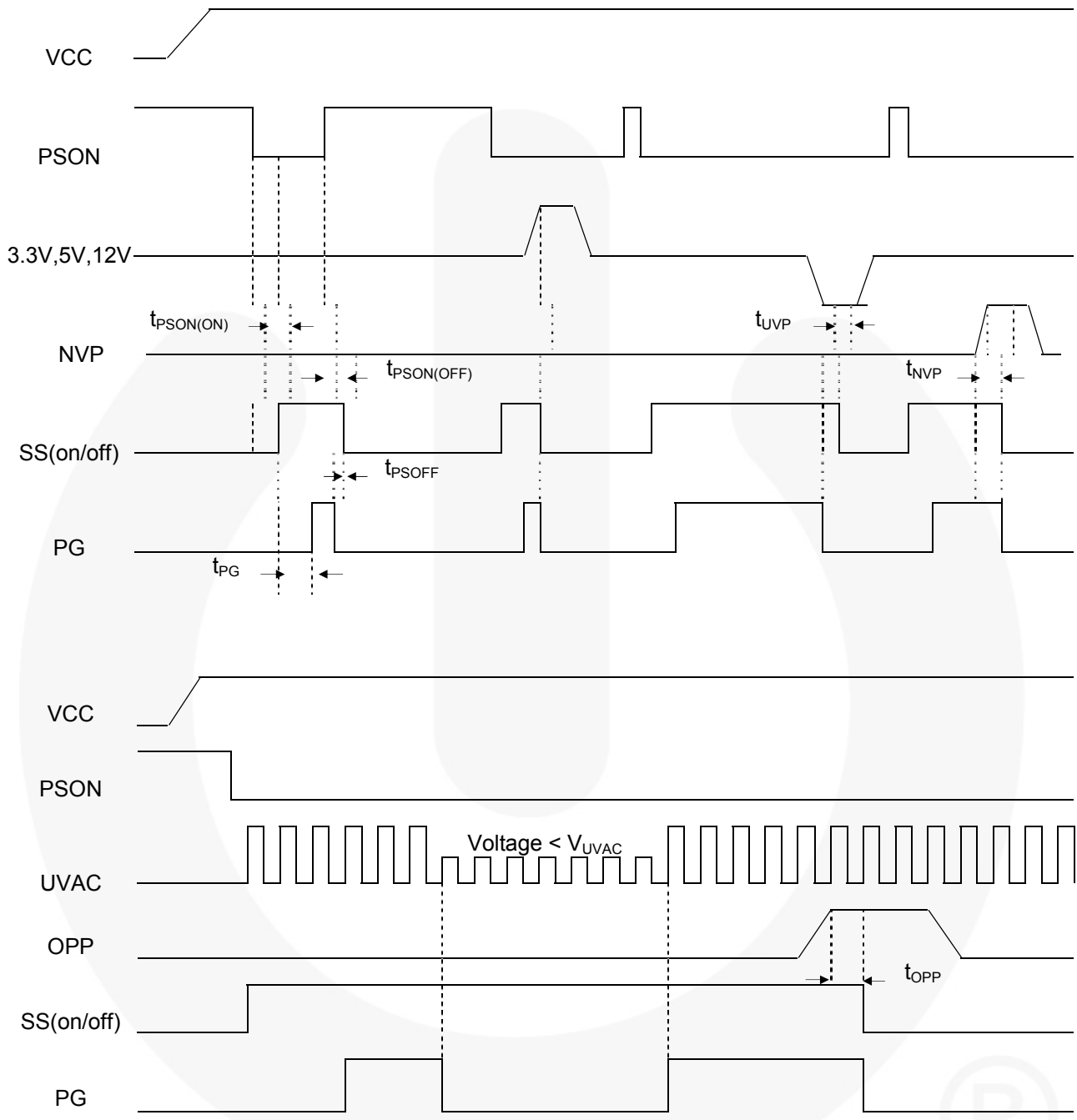
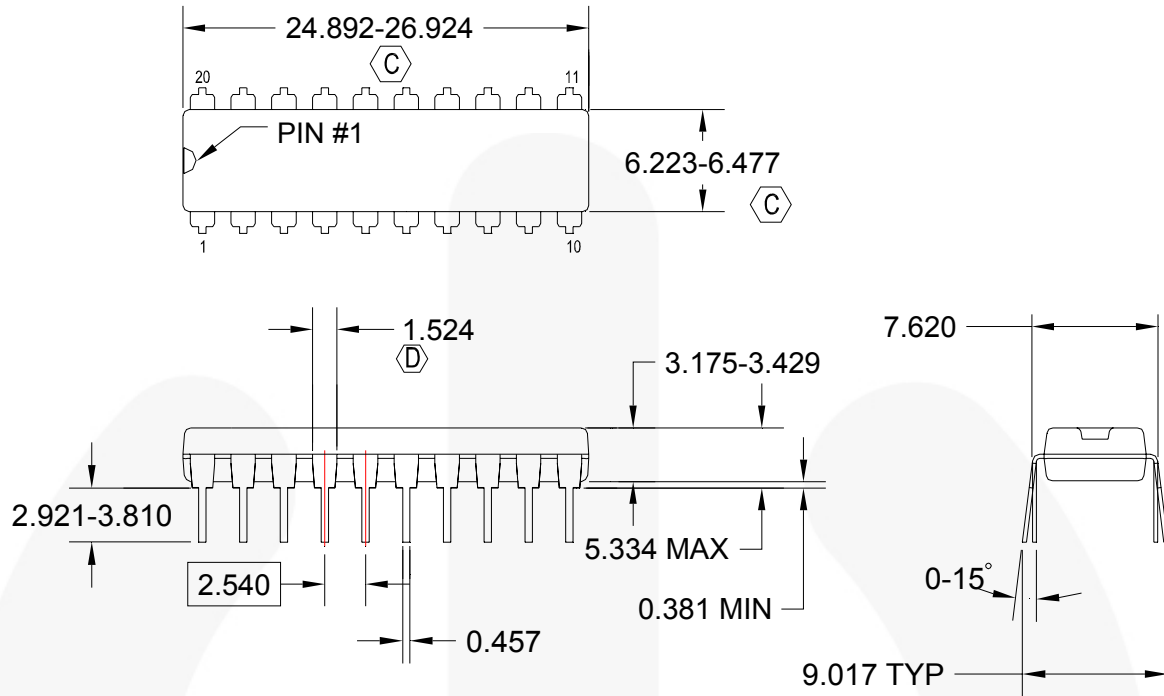

Figure 20. Timing Diagram

BOM

Reference	Component	Reference	Component
D1,D2,D6	PR1004	R14	100KΩ 1%
D3	2A45V	R15	47KΩ 1/8W
D4,D5	30C40	R16	9.47KΩ 1/8W
D7,D8,D9,D10,D11	1N4148	R17	1.5KΩ 1%
R1	62KΩ 1/8W	R18	1.45KΩ 1%
R2	3.2KΩ 1/8W	R19	39Ω 1/8W
R3	510Ω 1%	R20	1KΩ 1/8W
R4	1.5KΩ 1%	R21	96.7KΩ 1/8W
R5	100Ω 1/8W	R22	10KΩ 1/8W
R6	100Ω 1/8W	C1	101/50V
R7	1KΩ 1/8W	C2,C5	2.2μF/50V
R8	47~100Ω	C3,C6	103/50V
R9	1KΩ	C4	333/50V
R10	95.3KΩ	Q1	A928
R11	93.7KΩ	Q2,Q3	2SC945
R12	75 KΩ	U1	PC817
R13	14.2KΩ	U2	SG6105A

Physical Dimensions



NOTES:

- A. CONFORMS TO JEDEC REGISTRATION MS-001, VARIATIONS AD
- B. ALL DIMENSIONS ARE IN MILLIMETERS
- (C) DOES NOT INCLUDE MOLD FLASH OR PROTRUSIONS. MOLD FLASH OR PROTRUSIONS SHALL NOT EXCEED 0.25MM.
- (D) DOES NOT INCLUDE DAMBAR PROTRUSIONS. DAMBAR PROTRUSIONS SHALL NOT EXCEED 0.25MM.
- E. DRAWING FILE NAME: N20SREV1

Figure 22. 20-Lead Dual Inline Package (DIP)







Package drawings are provided as a service to customers considering Fairchild components. Drawings may change in any manner without notice. Please note the revision and/or date on the drawing and contact a Fairchild Semiconductor representative to verify or obtain the most recent revision. Package specifications do not expand the terms of Fairchild's worldwide terms and conditions, specifically the warranty therein, which covers Fairchild products.

Always visit Fairchild Semiconductor's online packaging area for the most recent package drawings:
<http://www.fairchildsemi.com/packaging/>



TRADEMARKS

The following includes registered and unregistered trademarks and service marks, owned by Fairchild Semiconductor and/or its global subsidiaries, and is not intended to be an exhaustive list of all such trademarks.

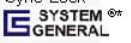
- | | | | |
|---|---|---|---|
| AccuPower™ | FPST™ | PowerTrench® | The Power Franchise® |
| Auto-SPM™ | F-PFST™ | PowerXS™ |  |
| Build it Now™ | FRFET® | Programmable Active Droop™ | TinyBoost™ |
| CorePLUS™ | Global Power Resource SM | QFET® | TinyBuck™ |
| CorePOWER™ | Green FPST™ | QS™ | TinyCalc™ |
| CROSSVOLT™ | Green FPST™ e-Series™ | Quiet Series™ | TinyLogic® |
| CTL™ | Gmax™ | RapidConfigure™ | TINYOPTO™ |
| Current Transfer Logic™ | GTO™ |  | TinyPower™ |
| EcoSPARK® | IntelliMAX™ | Saving our world, 1mWWW/KW at a time™ | TinyPWM™ |
| EfficientMax™ | ISOPLANAR™ | SmartMax™ | TinyWire™ |
| EZSWITCH™ | MegaBuck™ | SMART START™ | TriFault Detect™ |
|  | MICROCOUPLER™ | SPM® | TRUECURRENT™ |
|  | MicroFET™ | STEALTH™ | µSerDes™ |
| Fairchild® | MicroPak™ | SuperFET™ |  |
| Fairchild Semiconductor® | MillerDrive™ | SuperSOT™.3 | UHC® |
| FACT Quiet Series™ | MotionMax™ | SuperSOT™.6 | Ultra FRFET™ |
| FACT® | Motion-SPM™ | SuperSOT™.8 | UniFET™ |
| FAST® | OPTOLOGIC® | SupreMOS™ | VXC™ |
| FastvCore™ | OPTOPLANAR® | SyncFET™ | VisualMax™ |
| FETBench™ |  | Sync-Lock™ | XST™ |
| FlashWriter SM | PDP SPM™ |  | |
| | Power-SPM™ | | |

* Trademarks of System General Corporation, used under license by Fairchild Semiconductor.

DISCLAIMER

FAIRCHILD SEMICONDUCTOR RESERVES THE RIGHT TO MAKE CHANGES WITHOUT FURTHER NOTICE TO ANY PRODUCTS HEREIN TO IMPROVE RELIABILITY, FUNCTION, OR DESIGN. FAIRCHILD DOES NOT ASSUME ANY LIABILITY ARISING OUT OF THE APPLICATION OR USE OF ANY PRODUCT OR CIRCUIT DESCRIBED HEREIN; NEITHER DOES IT CONVEY ANY LICENSE UNDER ITS PATENT RIGHTS, NOR THE RIGHTS OF OTHERS. THESE SPECIFICATIONS DO NOT EXPAND THE TERMS OF FAIRCHILD'S WORLDWIDE TERMS AND CONDITIONS, SPECIFICALLY THE WARRANTY THEREIN, WHICH COVERS THESE PRODUCTS.

LIFE SUPPORT POLICY

FAIRCHILD'S PRODUCTS ARE NOT AUTHORIZED FOR USE AS CRITICAL COMPONENTS IN LIFE SUPPORT DEVICES OR SYSTEMS WITHOUT THE EXPRESS WRITTEN APPROVAL OF FAIRCHILD SEMICONDUCTOR CORPORATION.

As used herein:

- Life support devices or systems are devices or systems which, (a) are intended for surgical implant into the body or (b) support or sustain life, and (c) whose failure to perform when properly used in accordance with instructions for use provided in the labeling, can be reasonably expected to result in a significant injury of the user.
- A critical component in any component of a life support, device, or system whose failure to perform can be reasonably expected to cause the failure of the life support device or system, or to affect its safety or effectiveness.

ANTI-COUNTERFEITING POLICY

Fairchild Semiconductor Corporation's Anti-Counterfeiting Policy. Fairchild's Anti-Counterfeiting Policy is also stated on our external website, www.fairchildsemi.com, under Sales Support.

Counterfeiting of semiconductor parts is a growing problem in the industry. All manufacturers of semiconductor products are experiencing counterfeiting of their parts. Customers who inadvertently purchase counterfeit parts experience many problems such as loss of brand reputation, substandard performance, failed applications, and increased cost of production and manufacturing delays. Fairchild is taking strong measures to protect ourselves and our customers from the proliferation of counterfeit parts. Fairchild strongly encourages customers to purchase Fairchild parts either directly from Fairchild or from Authorized Fairchild Distributors who are listed by country on our web page cited above. Products customers buy either from Fairchild directly or from Authorized Fairchild Distributors are genuine parts, have full traceability, meet Fairchild's quality standards for handling and storage and provide access to Fairchild's full range of up-to-date technical and product information. Fairchild and our Authorized Distributors will stand behind all warranties and will appropriately address any warranty issues that may arise. Fairchild will not provide any warranty coverage or other assistance for parts bought from Unauthorized Sources. Fairchild is committed to combat this global problem and encourage our customers to do their part in stopping this practice by buying direct or from authorized distributors.

PRODUCT STATUS DEFINITIONS

Definition of Terms

Datasheet Identification	Product Status	Definition
Advance Information	Formative / In Design	Datasheet contains the design specifications for product development. Specifications may change in any manner without notice.
Preliminary	First Production	Datasheet contains preliminary data; supplementary data will be published at a later date. Fairchild Semiconductor reserves the right to make changes at any time without notice to improve design.
No Identification Needed	Full Production	Datasheet contains final specifications. Fairchild Semiconductor reserves the right to make changes at any time without notice to improve the design.
Obsolete	Not In Production	Datasheet contains specifications on a product that is discontinued by Fairchild Semiconductor. The datasheet is for reference information only.

Rev. I41