



Product Description: **T460HW03 TFT-LCD PANEL**

AUO Model Name: **T460HW03 V1**

Customer Part No. / Project Name:

Customer Signature

AU Optronics Corp.

Approved by: PM Head / Frank Hsu

Frank Hsu.

Reviewed by: RD Head / Hong-Jye Hong

Hong, Hong Jye 7/3 2008

Reviewed by: Project Leader / Ken Chen

Ken YJ Chen

Prepared by: PM / Eric Chiang

ERIC

Note



Document Version: 0.1

Date: 2008/11/4

Product Functional Specification

**46" Full HD Color TFT-LCD Module
Model Name: T460HW03 V1**

**() Preliminary Specification
(* Final Specification)**



Contents

No	
	CONTENTS
	RECORD OF REVISIONS
1	GENERAL DESCRIPTION
2	ABSOLUTE MAXIMUM RATINGS
3	ELECTRICAL SPECIFICATION
3-1	ELECTRICAL CHARACTERISTICS
3-2	INTERFACE CONNECTOR
3-3	SIGNAL TIMING SPECIFICATION
3-4	SIGNAL TIMING WAVEFORM
3-5	COLOR INPUT DATA REFERENCE
3-6	POWER SEQUENCE
3-7	BACK LIGHT POWER SPECIFICATION
4	OPTICAL SPECIFICATION
5	MECHANICAL CHARACTERISTICS
6	Reliability
7	INTERNATIONAL STANDARD
8	PACKING
9	PRECAUTION



Record of Revision

Version	Date	Page.	Old Description	New Description	Remark
0.0	2008/7/3		First release	N/A	N/A
0.1	2008/11/4	22,23	N/A	2D drawing update	N/A
0.1	2008/11/4	17	N/A	B/B connector pin assignment modification	N/A



1. General Description

This specification applies to the 46 inch Color TFT-LCD Module T460HW03 V1. This LCD module has a TFT active matrix type liquid crystal panel 1920x1080 pixels, and diagonal size of 46 inch. This module supports Full HD mode (Non-interlace).

Each pixel is divided into Red, Green and Blue sub-pixels or dots which are arranged in vertical stripes. Gray scale or the brightness of the sub-pixel color is determined with a 8-bit gray scale signal for each dot.

The T460HW03 V1 has been designed to apply the 8-bit 2 channel LVDS interface method. It is intended to support displays where high brightness, EBU Gamut (72% NTSC), wide viewing angle, and high color depth are very important.

The T460HW03 V1 backlight unit is using inverter-less solution (inductor type balance board), and need to be powered by integrated power system by customers.

* General Information

Items	Specification	Unit	Note
Active Screen Size	46	inches	Diagonal
Display Area	1018.08(H) x 572.67(V)	mm	
Outline Dimension	1083.0(H) x 627.0(V) x 50.6(D)	mm	With Balance Board
Driver Element	a-Si TFT active matrix		
Display Colors	16.7M	Colors	
Color Gamut	72	%	NTSC
Number of Pixels	1920 x 1080	Pixel	
Pixel Arrangement	RGB vertical stripe		
Pixel Pitch	0.53025	mm	
Display Mode	Normally Black		
Surface Treatment	Haze 11%, 3H		
RoHS	RoHS compliance		



2. Absolute Maximum Ratings

The followings are maximum values which, if exceeded, may cause faulty operation or damage to the unit

Item	Symbol	Min.	Max	Unit	Note
Logic/LCD Drive Voltage	V_{DD}	-0.3	14.0	V_{DC}	1
Input Voltage of Signal	V_{IN}	-0.3	3.6	V_{DC}	1
Operating Temperature	T_{OP}	0	+50	$^{\circ}C$	2
Operating Humidity	H_{OP}	10	90	%RH	2
Storage Temperature	T_{ST}	-20	+60	$^{\circ}C$	2
Storage Humidity	H_{ST}	10	90	%RH	2
Panel Surface Temperature	T_{SUR}	--	+65	$^{\circ}C$	2
Shock (non-operation)	$\pm x, \pm y$	--	40	G	3
Shock (non-operation)	$\pm z$	--	30	G	3
Vibration (non-operation)		--	1.5	G	4

Note 1: Duration = 50ms

Note 2: Maximum Wet-Bulb should be $39^{\circ}C$ and no condensation. The relative humidity must not exceed 90% non-condensing at temperatures of $40^{\circ}C$ or less. At temperatures greater than $40^{\circ}C$, the wet bulb temperature must not exceed $39^{\circ}C$.

Note 3: Sine wave, 11ms, direction: $\pm x, \pm y, \pm z$ (one time each direction)

Note 4: Wave form: random, vibration level: 1.5G RMS, Bandwidth: 10--300Hz

Duration: X, Y, Z 30min (one time each direction)

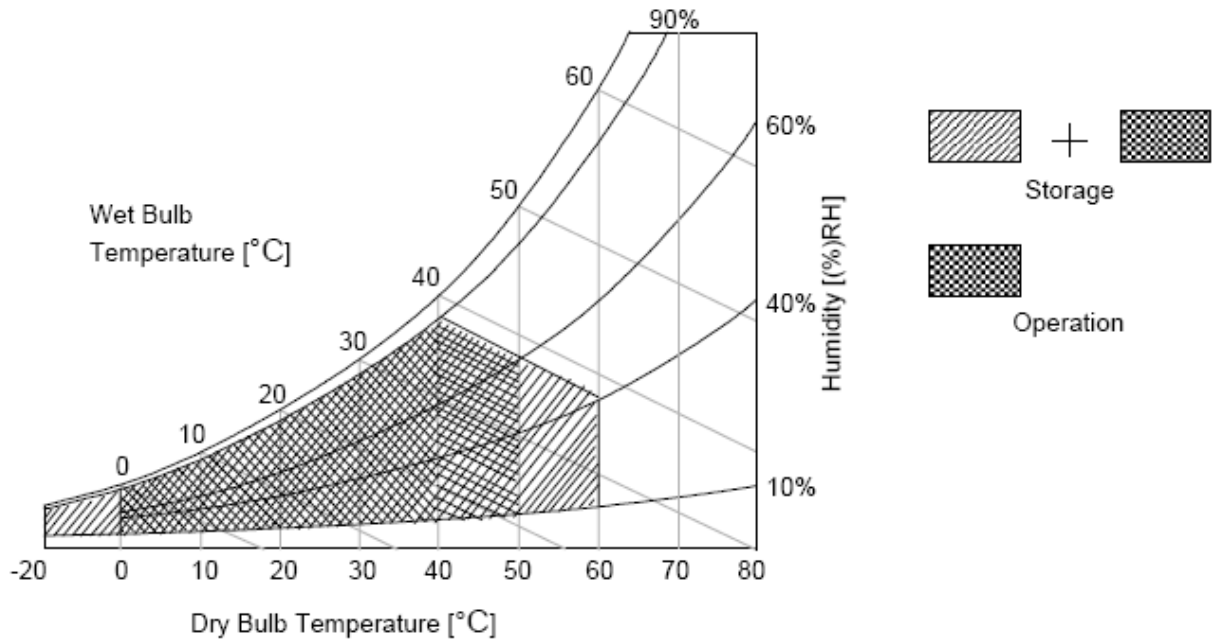



3. Electrical Specification

The T460HW03 V1 requires two power inputs. One is employed to power the LCD electronics and to drive the TFT array and liquid crystal. The second input, which powers the CCFL, is typically generated by an integrate power (I/P) system.

3.1 Electrical Characteristics

Parameter		Symbol	Value			Unit	Note
			Min.	Typ.	Max		
Power Supply Input Voltage		V_{DD}	10.8	12.0	13.2	V_{DC}	
Power Supply Input Current		I_{DD}	--	1.35	1.5	A	1
Power Consumption		P_C	--	16.2	19.8	Watt	1
Inrush Current		I_{RUSH}	--	--	4.5	A	5
LVDS Interface	Differential Input High Threshold Voltage	V_{TH}	--	--	+100	mV_{DC}	4
	Differential Input Low Threshold Voltage	V_{TL}	-100	--	--	mV_{DC}	4
	Common Input Voltage	V_{CIM}	1.10	1.25	1.40	V_{DC}	
CMOS Interface	Input High Threshold Voltage	V_{IH} (High)	2.4	--	3.3	V_{DC}	
	Input Low Threshold Voltage	V_{IL} (Low)	0	--	0.7	V_{DC}	
Backlight Power Consumption (ref.)		P_{BL}	--	210	--	Watt	2
Life Time			50000	--	--	Hours	3

The performance of the Lamp in LCD panel, for example life time or brightness, is extremely influenced by the characteristics of the balance board and I/P board. All the parameters should be carefully designed as not to produce too much leakage current from high-voltage output. While design or order balance board, please make sure unwanted lighting caused by the mismatch of the lamp and balance board (no lighting, flicker, etc) never occurs. After confirmation, the LCD Panel should be operated in the same condition as installed in your instrument.

Do not attach a conducting tape to lamp connecting wire. If the lamp wire attach to conducting tape, TFT-LCD Module has a low luminance and the inverter has abnormal action, because leakage current occurs between lamp wire and conducting tape.

When operate at low temperatures, the brightness of CCFL will drop and the lifetime of CCFL will be reduced.

Note:

1. $V_{DD}=12.0V$, $f_V=60Hz$, $f_{CLK}=81.5Mhz$, $25^\circ C$, V_{DD} duration time= $400\mu s$, test pattern: white pattern
2. The backlight power consumption shown above is tested by lamp current $I_L=7.6mA$.
3. The life is determined as the time at which luminance of the lamp is 50% compared to that of initial value at the typical lamp current on condition of continuous operating at $25\pm 2^\circ C$.
4. $V_{CIM}=1.25V$

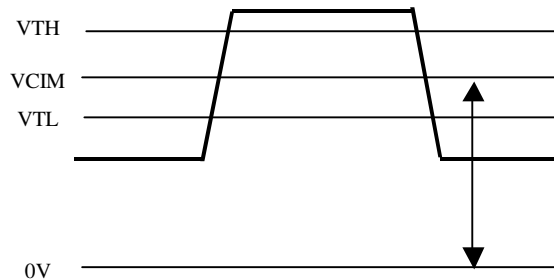
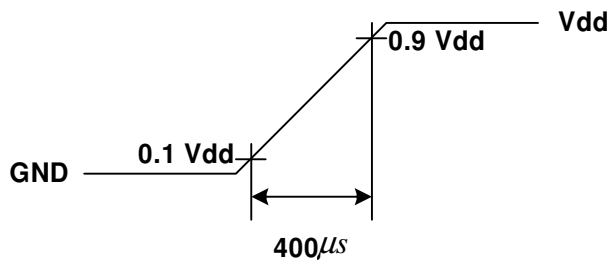

Figure: LVDS Differential Voltage

5. Measurement condition: rising time= $400\mu s$





3.2 Interface Connections

- LCD connector: FI-RE51S-HF (JAE)
- Mating connector: FI-RE51S-HL (JAE)

PIN #	Signal Name	Description
1	V _{DD}	12V power supply
2	V _{DD}	12V power supply
3	V _{DD}	12V power supply
4	V _{DD}	12V power supply
5	V _{DD}	12V power supply
6	GND	Ground
7	GND	Ground
8	GND	Ground
9	GND	Ground
10	RO_0-	Negative(-) LVDS differential data input
11	RO_0+	Positive(+) LVDS differential data input
12	RO_1-	Negative(-) LVDS differential data input
13	RO_1+	Positive(+) LVDS differential data input
14	RO_2-	Negative(-) LVDS differential data input
15	RO_2+	Positive(+) LVDS differential data input
16	GND	Ground
17	RO_CLK-	Clock Signal(-)
18	RO_CLK+	Clock Signal(+)
19	GND	Ground
20	RO_3-	Negative(-) LVDS differential data input
21	RO_3+	Positive(+) LVDS differential data input
22	NC	No connection
23	NC	No connection
24	GND	Ground
25	RE_0-	Negative(-) LVDS differential data input
26	RE_0+	Positive(+) LVDS differential data input
27	RE_1-	Negative(-) LVDS differential data input
28	RE_1+	Positive(+) LVDS differential data input
29	RE_2-	Negative(-) LVDS differential data input
30	RE_2+	Positive(+) LVDS differential data input
31	GND	Ground



PIN #	Signal Name	Description
32	RE_CLK-	Clock Signal(-)
33	RE_CLK+	Clock Signal(+)
34	GND	Ground
35	RE_3-	Negative(-) LVDS differential data input
36	RE_3+	Positive(+) LVDS differential data input
37	NC	No connection
38	NC	No connection
39	GND	Ground
40	NC	No connection
41	NC	No connection
42	NC	No connection
43	NC	No connection
44	NC	No connection
45	LVDS	Select LVDS data order (NS: High/Open, JEIDA: Low)
46	NC	No connection
47	NC	No connection
48	NC (reserved)	No connection (AUO internal use)
49	NC (reserved)	No connection (AUO internal use)
50	NC (reserved)	No connection (AUO internal use)
51	NC (reserved)	No connection (AUO internal use)

Note 1: All GND (ground) pins should be connected together and should also be connected to the LCD's metal frame.

Note 2: All V_{DD} (power input) pins should be connected together.

Note 3: All NC (no connection) pins should be open without voltage input.



LVDS Option = High/Open → NS

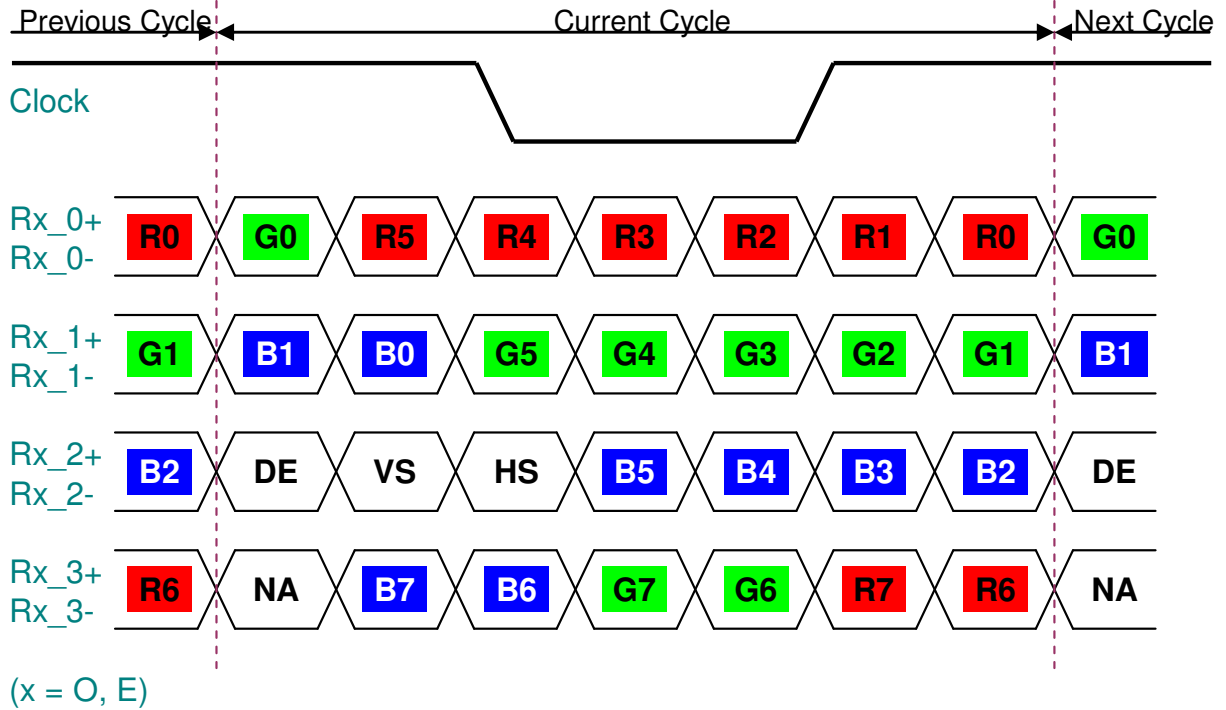

LVDS Option = Low → JEIDA

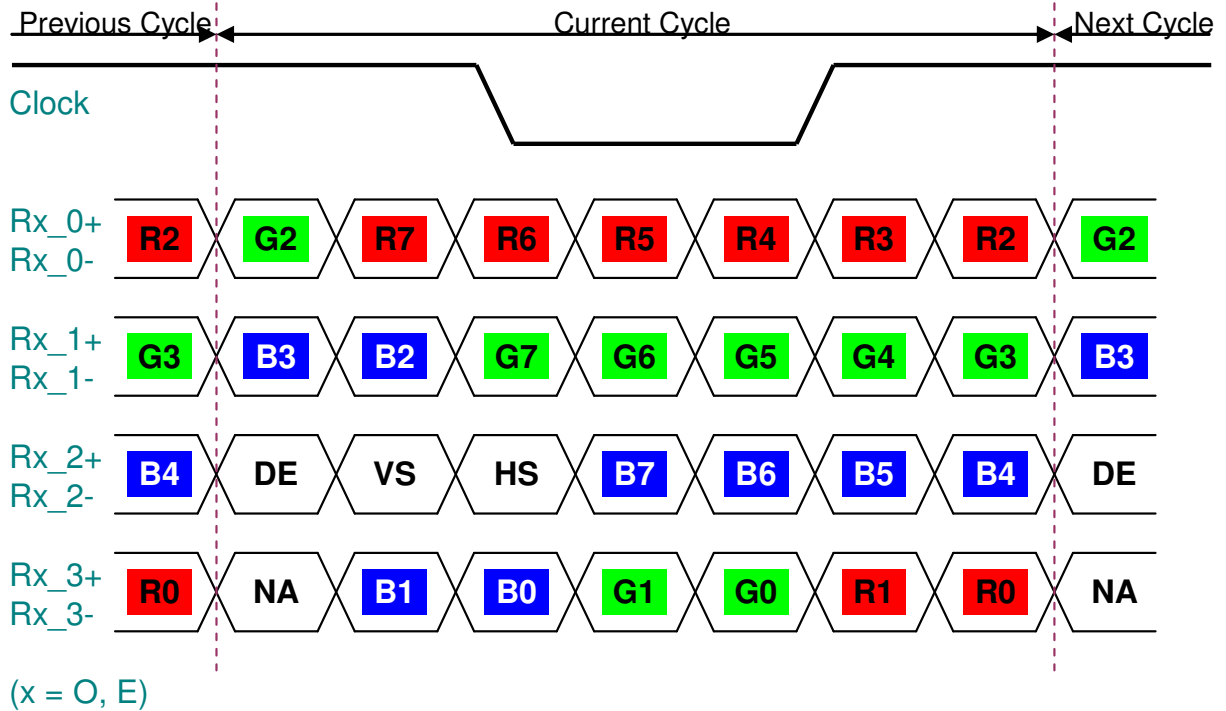



3.3 Signal Timing Specification

This is the signal timing required at the input of the user connector. All of the interface signal timing should be satisfied with the following specifications for its proper operation.

Timing Table (DE only Mode)

Vertical Frequency Range (60Hz)

Signal	Item	Symbol	Min.	Typ.	Max	Unit
Vertical Section	Period	T_V	1090	1130	1200	T_H
	Active	$T_{DISP} (V)$	1080			T_H
	Blanking	$T_{BLK} (V)$	10	50	120	T_H
Horizontal Section	Period	T_H	1090	1100	1120	T_{CLK}
	Active	$T_{DISP} (H)$	960			T_{CLK}
	Blanking	$T_{BLK} (H)$	130	140	160	T_{CLK}
Clock	Period	T_{CLK}	11.81	13.41	14.766	ns
	Frequency	F_{CLK}	67.722	74.58	84.672	MHz
Vertical Frequency	Frequency	F_V	57	60	63	Hz
Horizontal Frequency	Frequency	F_H	62.13	67.8	75.6	KHz

Vertical Frequency Range (50Hz)

Signal	Item	Symbol	Min.	Typ.	Max	Unit
Vertical Section	Period	T_V	1330	1356	1410	T_H
	Active	$T_{DISP} (V)$	1080			T_H
	Blanking	$T_{BLK} (V)$	250	276	330	T_H
Horizontal Section	Period	T_H	1090	1100	1120	T_{CLK}
	Active	$T_{DISP} (H)$	960			T_{CLK}
	Blanking	$T_{BLK} (H)$	130	140	160	T_{CLK}
Clock	Period	T_{CLK}	11.958	13.41	14.677	ns
	Frequency	F_{CLK}	68.136	74.58	83.698	MHz
Vertical Frequency	Frequency	F_V	47	50	53	Hz
Horizontal Frequency	Frequency	F_H	62.51	67.8	74.73	KHz

3.4 Signal Timing Waveforms

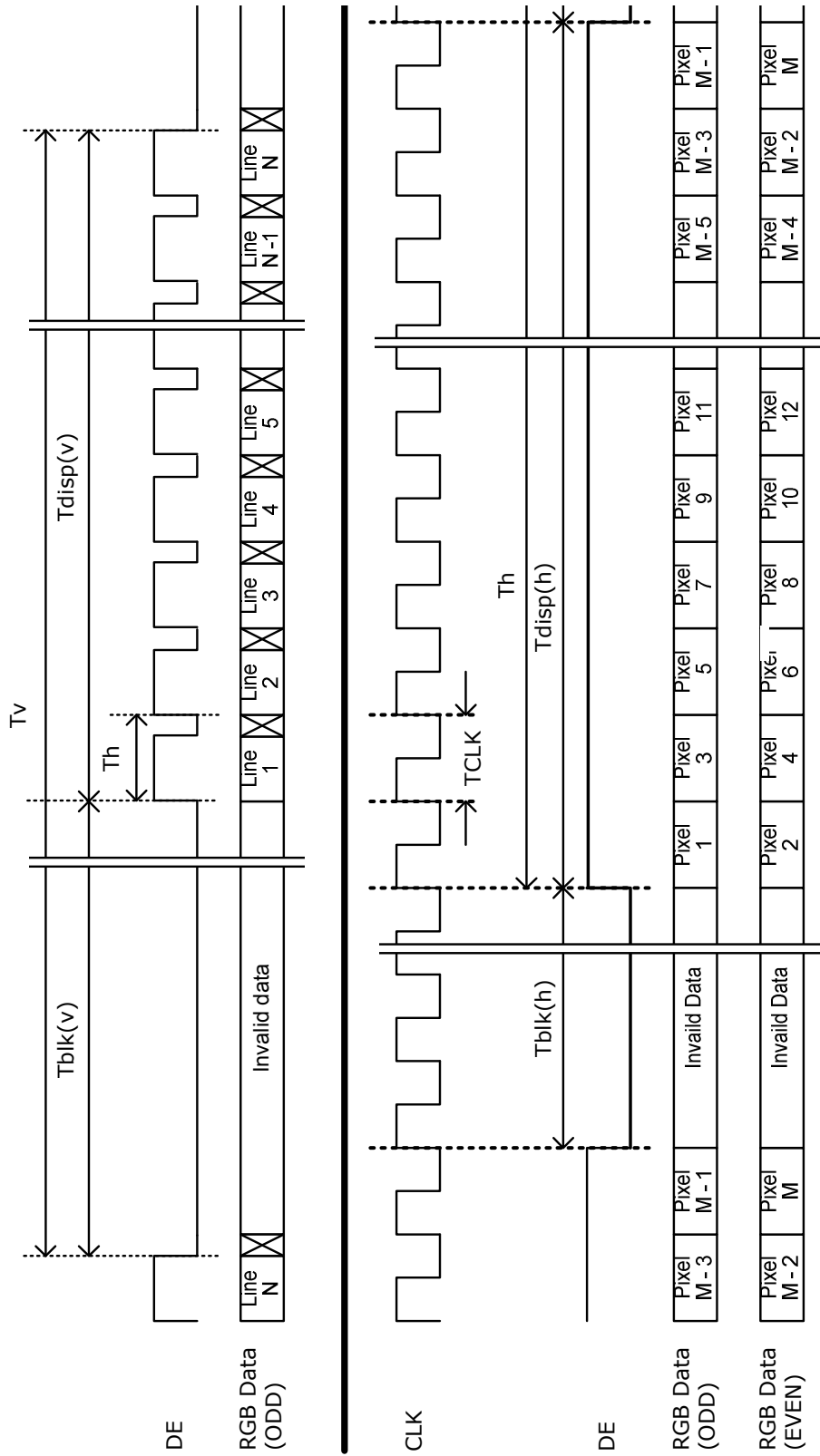



3.5 Color Input Data Reference

The brightness of each primary color (red, green and blue) is based on the 8 bit gray scale data input for the color; the higher the binary input, the brighter the color. The table below provides a reference for color versus data input.

COLOR DATA REFERENCE

Color		Input Color Data																							
		RED								GREEN								BLUE							
		MSB				LSB				MSB				LSB				MSB				LSB			
		R7	R6	R5	R4	R3	R2	R1	R0	G7	G6	G5	G4	G3	G2	G1	G0	B7	B6	B5	B4	B3	B2	B1	B0
Basic Color	Black	0	0	0	0	0	0	0	0	0	0	0	0	0	0	0	0	0	0	0	0	0	0	0	0
	Red(255)	1	1	1	1	1	1	1	1	0	0	0	0	0	0	0	0	0	0	0	0	0	0	0	
	Green(255)	0	0	0	0	0	0	0	0	1	1	1	1	1	1	1	0	0	0	0	0	0	0	0	
	Blue(255)	0	0	0	0	0	0	0	0	0	0	0	0	0	0	0	1	1	1	1	1	1	1	1	
	Cyan	0	0	0	0	0	0	0	0	1	1	1	1	1	1	1	1	1	1	1	1	1	1	1	
	Magenta	1	1	1	1	1	1	1	1	0	0	0	0	0	0	0	1	1	1	1	1	1	1	1	
	Yellow	1	1	1	1	1	1	1	1	1	1	1	1	1	1	1	0	0	0	0	0	0	0	0	
	White	1	1	1	1	1	1	1	1	1	1	1	1	1	1	1	1	1	1	1	1	1	1	1	
RED	RED(000)	0	0	0	0	0	0	0	0	0	0	0	0	0	0	0	0	0	0	0	0	0	0		
	RED(001)	0	0	0	0	0	0	1	0	0	0	0	0	0	0	0	0	0	0	0	0	0	0		

	RED(254)	1	1	1	1	1	1	1	0	0	0	0	0	0	0	0	0	0	0	0	0	0	0		
	RED(255)	1	1	1	1	1	1	1	0	0	0	0	0	0	0	0	0	0	0	0	0	0	0		
GREEN	GREEN(000)	0	0	0	0	0	0	0	0	0	0	0	0	0	0	0	0	0	0	0	0	0	0		
	GREEN(001)	0	0	0	0	0	0	0	0	0	0	0	0	0	1	0	0	0	0	0	0	0	0		

	GREEN(254)	0	0	0	0	0	0	0	1	1	1	1	1	1	0	0	0	0	0	0	0	0	0		
	GREEN(255)	0	0	0	0	0	0	0	1	1	1	1	1	1	1	0	0	0	0	0	0	0	0		
BLUE	BLUE(000)	0	0	0	0	0	0	0	0	0	0	0	0	0	0	0	0	0	0	0	0	0	0		
	BLUE(001)	0	0	0	0	0	0	0	0	0	0	0	0	0	0	0	0	0	0	0	0	0	1		

	BLUE(254)	0	0	0	0	0	0	0	0	0	0	0	0	0	0	1	1	1	1	1	1	1	0		
	BLUE(255)	0	0	0	0	0	0	0	0	0	0	0	0	0	0	1	1	1	1	1	1	1	1		

3.6 Power Sequence

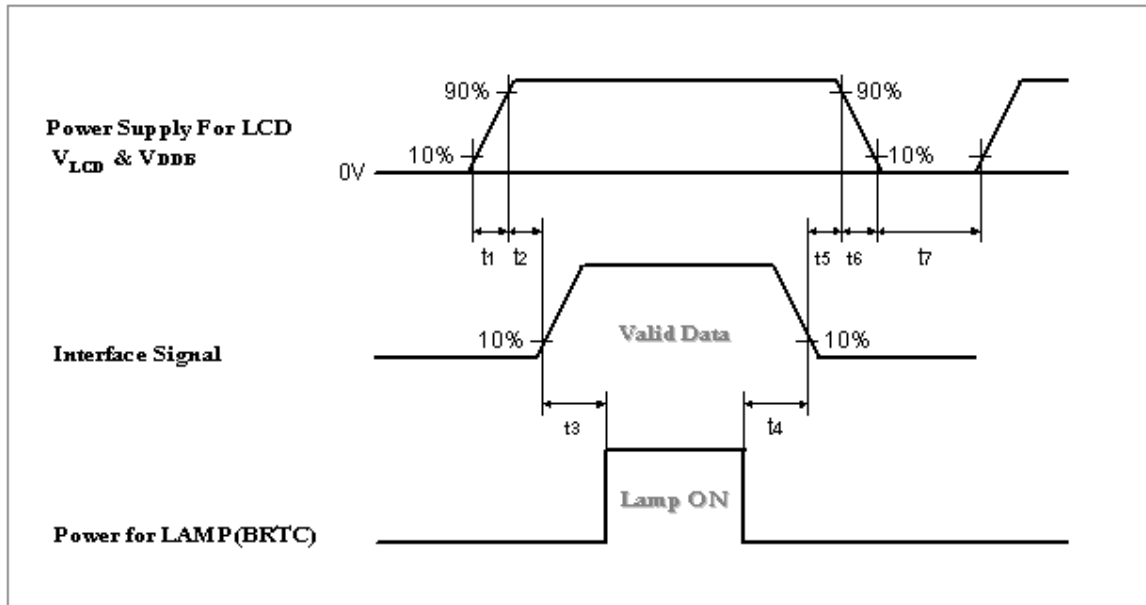

Parameter	Values			Unit
	Min.	Typ.	Max.	
t1	0.4	--	10	ms
t2	20	--	50	ms
t3	700 or (200)*	--	--	ms
t4	200	--	--	ms
t5	50	--	-	ms
t6	0.47	--	30	ms
t7	1000	--	--	ms

* If $t_3=200\text{ms}$, input black signal till 700ms from system is necessary. In case of $t_3<200\text{ms}$, the abnormal display will be happened. But it will not damage timing controller.

Apply the lamp voltage within the LCD operating range. When the backlight turns on before the LCD operation or the LCD turns off before the backlight turns off, the display may momentarily become abnormal.

Caution: The above on/off sequence should be applied to avoid abnormal function in the display. In case of handling, make sure to turn off the power when you plug the cable into the input connector or pull the cable out of the connector.



3.7 Backlight Power Specification

Specification

(Ta=25±5°C, Turn-on after 60mins)

	Item	Symbol	Specification			Unit	Note
			Min.	Typ.	Max		
1	Work Voltage	WV		1350	--	V _{RMS}	
2	Output Lamp Current	I _{OUT}	7.3	7.6	7.9	mA _{RMS}	PWM=100%
3	Operating Frequency	F _{OP}	44	45	46	KHz	(Recommend)
4	PWM Dimming Frequency	F _{PWM}	140	150	160	Hz	(Recommend)
5	Dimming Duty Ratio	D _{PWM}	20	--	100	%	(Recommend)
6	Lamp Type	Straight					
7	Number of Lamps	20				pcs	

Protection Circuit (Feedback Signal):

8	Supply Voltage	V _{CC}	10	12	15	V _{DC}	
9	Current Feedback Signal	V _{FB}	1.8	2.0	2.2	V _{RMS}	
10	Lamp Detection (LD)	V _{LD} (H)	11.4	12	12.6	V _{DC}	Lamp normal status
		V _{LD} (L)	0	--	0.8	V _{DC}	Lamp protection status

Lamp Specification:

11	Output Working Voltage	V _L		1350		V _{RMS}	
12	Output Current	I _L	7.3	7.6	7.9	mA _{RMS}	
13	Lamp Frequency	F _{LAMP}	44	45	46	KHz	
14	Starting Voltage	VS (Master)	1200	--		V _{RMS}	For single side
		VS (Slave)	1200	--		V _{RMS}	For single side

Connector Pin Assignment

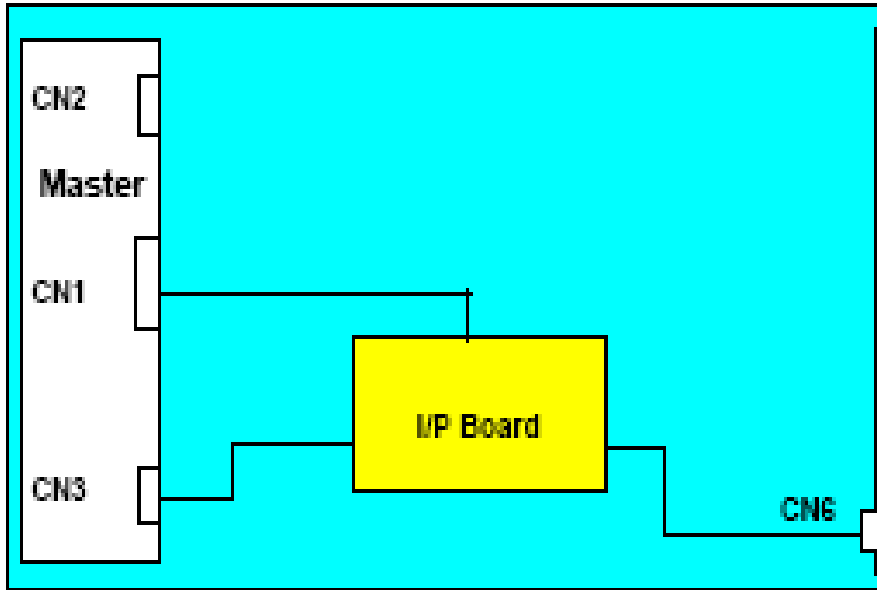

CN2 or CN3: YeonHO_130001WR-02E (LF)

PIN #	Symbol	Description
1	HV1+	I/P board high voltage supply
2	HV1+	I/P board high voltage supply

CN6: YeonHO_130001WR-02E (LF)

PIN #	Symbol	Description
1	HV2 -	I/P board high voltage supply
2	HV2-	I/P board high voltage supply

CN1: HIROSE_KN30-7P-1.25H

PIN #	Symbol	Description
1	VCC	Power Supply for Protection Circuit
2	IFB	Lamp Current feedback Signal (Full wave current)
3	IFB	Lamp Current feedback Signal (Full wave current)
4	GND	Signal Ground
5	GND	Signal Ground
6	LD	Lamp detection
7	LD	Lamp detection

4. Optical Specification

Optical characteristics are determined after the unit has been 'ON' and stable for approximately 60 minutes in a dark environment at 25°C. The values specified are at an approximate distance 500mm from the LCD surface at a viewing angle of φ and θ equal to 0°.

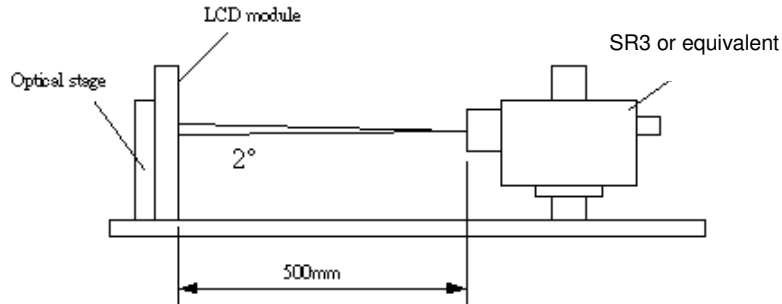

Parameter	Symbol	Values			Unit	Notes
		Min.	Typ.	Max		
Contrast Ratio	CR	3000	3500	--		1
Surface Luminance (White)	L_{WH}	400	500	--	cd/m ²	2
Luminance Variation	$\delta_{WHITE(9P)}$	--	--	1.3		3
Response Time (Average)	T _γ	--	6.5	--	ms	4 (Gray to Gray)
Color Coordinates						
Red	R _x	Typ.-0.03	0.640	Typ.+0.03		
	R _y		0.330			
Green	G _x		0.290			
	G _y		0.600			
Blue	B _x		0.150			
	B _y		0.060			
White	W _x		0.280			
	W _y		0.290			
Viewing Angle						
						(Contrast Ratio>10)
x axis, right($\varphi=0^\circ$)	θ_r	--	89	--	degree	5
x axis, left($\varphi=180^\circ$)	θ_l	--	89	--	degree	5
y axis, up($\varphi=90^\circ$)	θ_u	--	89	--	degree	5
y axis, down ($\varphi=270^\circ$)	θ_d	--	89	--	degree	5



Note:

1. Contrast Ratio (CR) is defined mathematically as:

$$\text{Contrast Ratio (CR)} = \frac{\text{Brightness of the "white" state}}{\text{Brightness of the "black" state}}$$

2. Surface Luminance is luminance value at point 5 with 100% dimming across the LCD surface 50cm from the surface with all pixels displaying white. For more information see Fig. 4-2. When lamp current $I_L=7.6\text{mA}$, $L_{WH}=L_{on5}$, where L_{on5} is the luminance with all pixels displaying white at center 5 location.

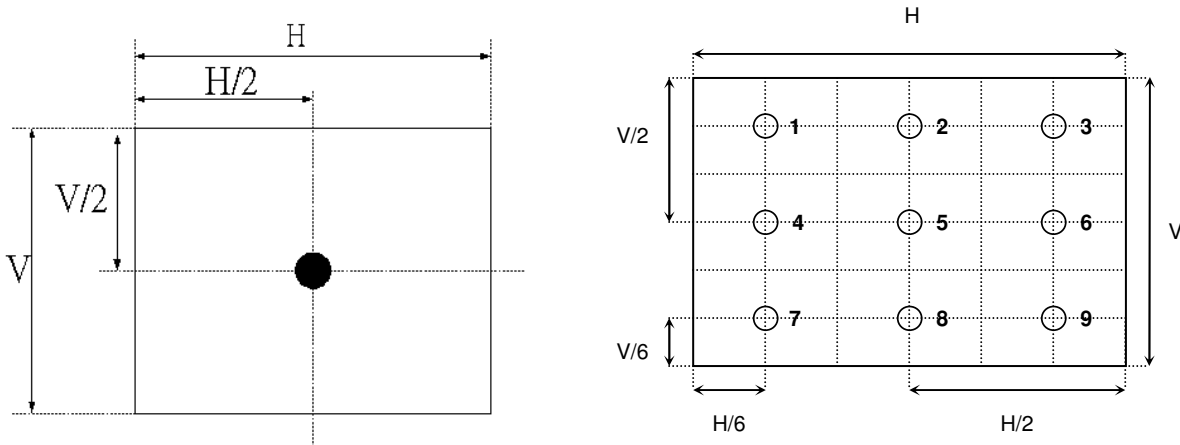

Fig.4-2 Optical measurement point

3. The variation in surface luminance, $\delta_{\text{WHITE(9P)}}$ is defined under brightness of $I_L=7.6\text{mA}$ as:

$$\delta_{\text{WHITE(9P)}} = \text{Maximum}(L_{on1}, L_{on2}, \dots, L_{on9}) / \text{Minimum}(L_{on1}, L_{on2}, \dots, L_{on9})$$

4. Response time T_γ is the average time required for display transition by switching the input signal for five luminance ratio (0%, 25%, 50%, 75%, 100% brightness matrix) and is based on $f_v=60\text{Hz}$ to optimize.

	0%	25%	50%	75%	100%
0%		t:0%-25%	t:0%-50%	t:0%-75%	t:0%-100%
25%	t:25%-0%		t:25%-50%	t:25%-75%	t:25%-100%
50%	t:50%-0%	t:50%-25%		t:50%-75%	t:50%-100%
75%	t:75%-0%	t:75%-25%	t:75%-50%		t:75%-100%
100%	t:100%-0%	t:100%-25%	t:100%-50%	t:100%-75%	

5. Viewing angle is the angle at which the contrast ratio is greater than 10. The angles are determined for the horizontal (or x-axis) and the vertical (or y-axis) with respect to the z-axis which is normal to the LCD surface. For more information see Fig. 4-4.

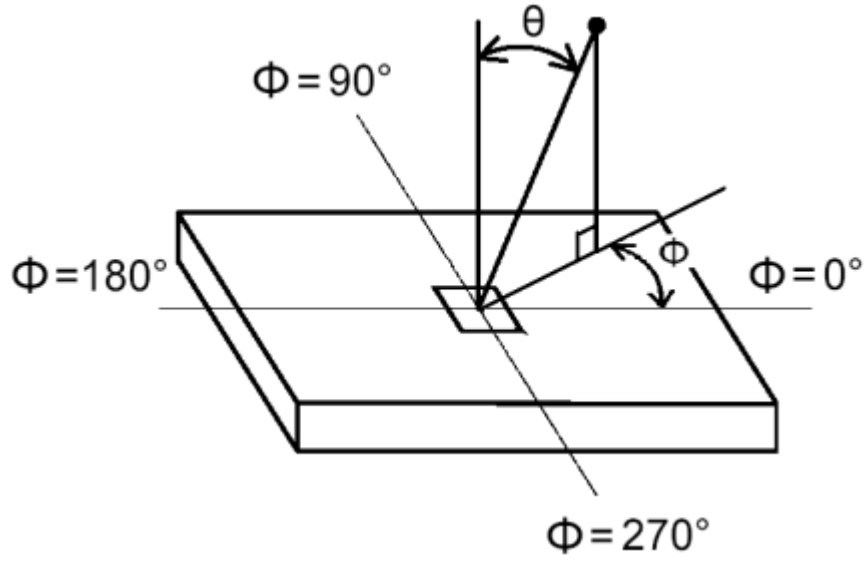

Fig.4-4 Viewing angle definition



5. Mechanical Characteristics

The contents provide general mechanical characteristics for the model T460HW03. In addition the figures in the next page are detailed mechanical drawing of the LCD.

Outline Dimension	Horizontal (typ.)	1083.0 mm
	Vertical (typ.)	627.0 mm
	Depth (typ.)	50.6 mm (with balance board)
Bezel Area	Horizontal (typ.)	1024.4 mm
	Vertical (typ.)	578.6 mm
Active Display Area	Horizontal	1018.08 mm
	Vertical	572.67 mm
Weight	15500g (Max)	
Surface Treatment	Haze 11%, 3H	

2D Drawing (Front)

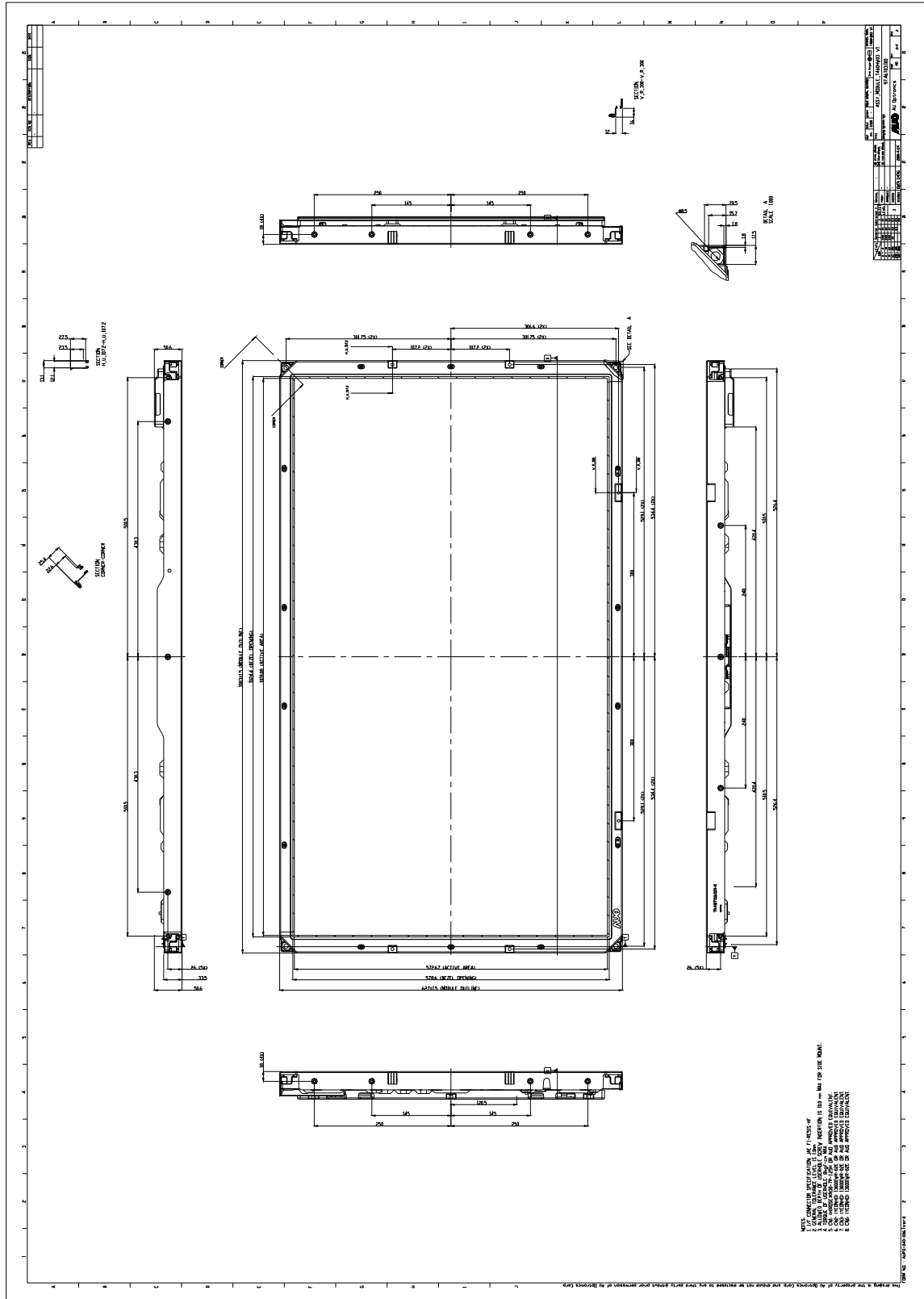



2D Drawing (Rear)

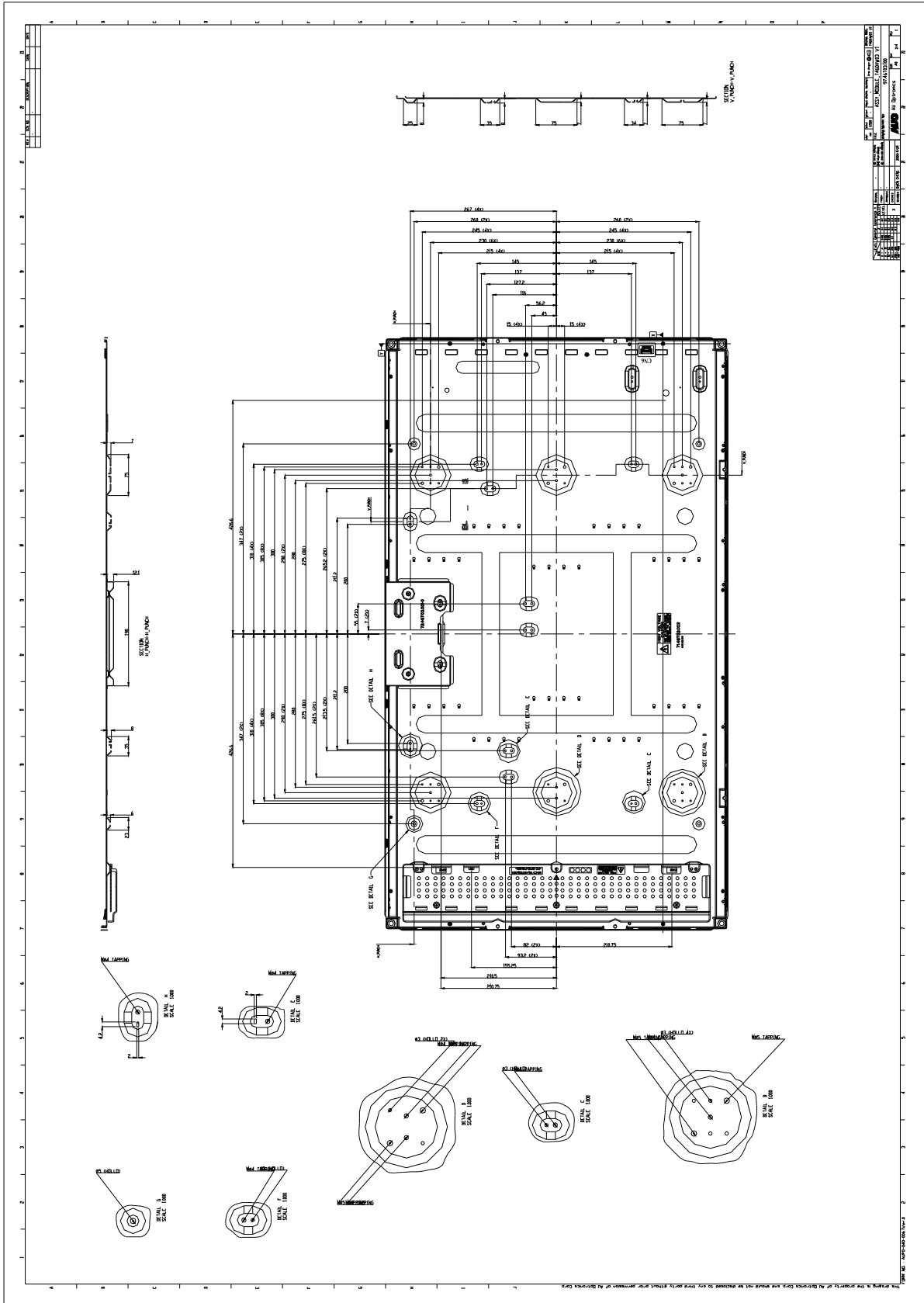



6. Reliability

Panel condition in RA test

Brightness: 500nits

Lamp Current (Hot side): 7.6mA

No	Test Item	Condition
1	High temperature storage test	Ta=60°C 300h
2	Low temperature storage test	Ta= -20°C 300h
3	High temperature operation test	Ta=50°C 300h
4	Low temperature operation test	Ta=-5°C 300h
5	Vibration test (non-operating)	Wave form: random Vibration level: 1.5G RMS Bandwidth: 10-300Hz, Duration: X, Y, Z 30min One time each direction
6	Shock test (non-operating)	Shock level: 50G Waveform: half sine wave, 11ms Direction: ±X, ±Y, ±Z One time each direction
7	Vibration test (with carton)	Wave form: random Vibration level: 1.5G RMS Bandwidth: 10-200Hz, Duration: X, Y, Z 30min One time each direction
8	Drop test (with carton)	Height: 25.4cm 1 corner, 3 edges, 6 surfaces (ASTMD4169-I)

Result Evaluation Criteria }

There should be no change which might affect the practical display function when the display quality test is conducted under normal operating condition.



7. International Standard

7-1. Safety

- (1) UL6500, UL 60065 Underwriters Laboratories, Inc. (AUO file number: E204356)
Standard for Safety of Information Technology Equipment Including electrical Business Equipment.
- (2) CAN/CSA C22.2 No. 950-95 Third Edition, Canadian Standards Association, Jan. 28, 1995
Standard for Safety of Information Technology Equipment Including Electrical Business Equipment.
- (3) EN60950: 1992+A2: 1993+A2: 1993+C3: 1995+A4: 1997+A11: 1997
IEC 950: 1991+A1: 1992+A2: 1993+C3: 1995+A4:1996
IEC 60065: version 7th
European Committee for Electro technical Standardization (CENELEC)
EUROPEAN STANDARD for Safety of Information Technology Equipment Including Electrical Business Equipment.

7-2. EMC

- (1) ANSI C63.4 "Methods of Measurement of Radio-Noise Emissions from Low-Voltage Electrical and Electrical Equipment in the Range of 9kHz to 40GHz. "American National standards Institute(ANSI), 1992
- (2) C.I.S.P.R "Limits and Methods of Measurement of Radio Interface Characteristics of Information Technology Equipment." International Special committee on Radio Interference.
- (3) EN 55022 "Limits and Methods of Measurement of Radio Interface Characteristics of Information Technology Equipment." European Committee for Electrotechnical Standardization. (CENELEC), 1998

7-3. Green Mark Description

- (1) For Pb Free products, AUO will add  for identification.
- (2) For RoHS compatible products, AUO will add RoHS for identification.

Note. The Green Mark will be present only when the green documents have been ready by AUO Internal Green Team. (The definition of green design follows the AUO green design checklist.)

8. Packing

Packing Instruction

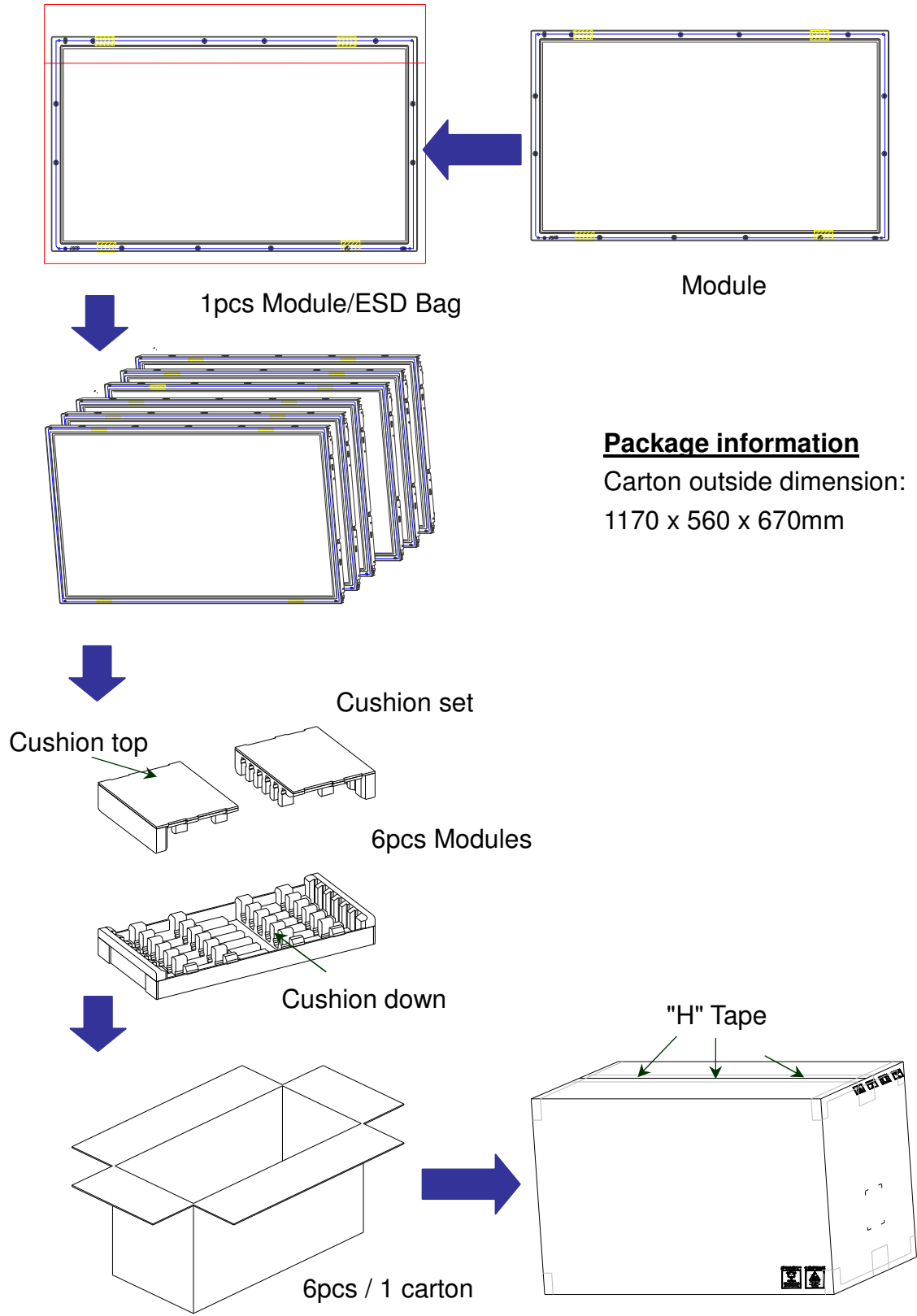

Pallet information

By air cargo: (2 x 1) x 1 layers, one pallet put 2 boxes, total 12 pcs module.

Dimension: 1140 x 1180 x 810mm

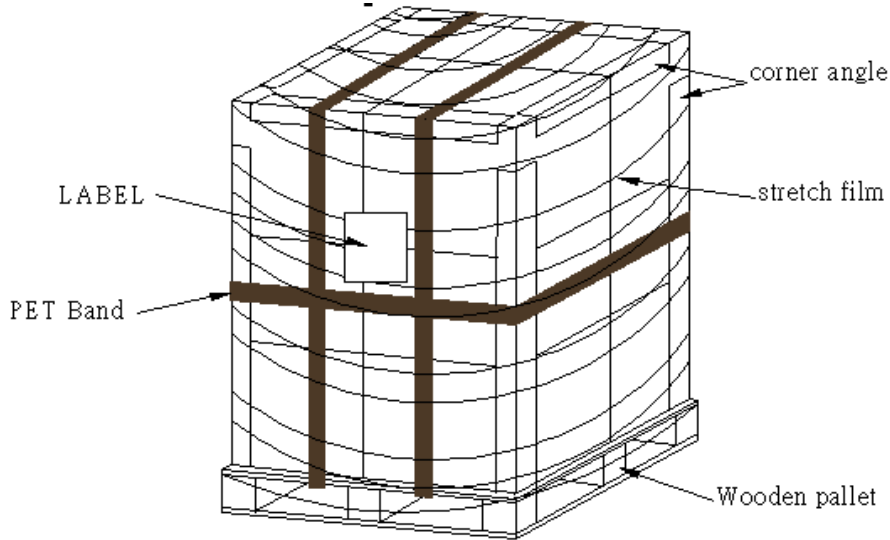

By sea: (2 x 1) x 2 layers, one pallet put 2 boxes, stack 2 layers, total 24 pcs module.

Dimension: 1140 x 1180 x 1620mm

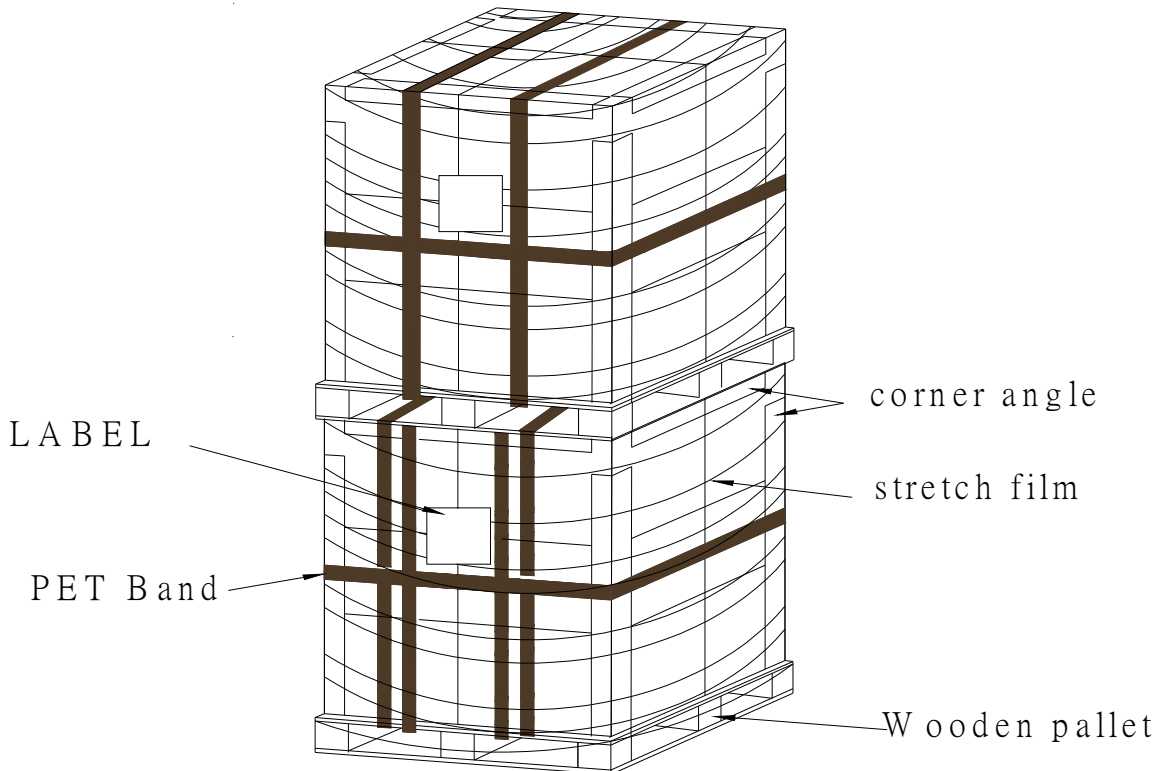

Pallet dimension: 1140 x 1180 x 138mm



Panel Label

	Manufactured XX/XX			
XXXXXXXXXXXX-XXXXXX	Model No T460HW03 V1			
	AU Optronics XXXXG			
	MADE IN TAIWAN (M11)			
AUXXXXXXXXXXXXXXXXXXXXXX				

Carton Label

AU Optronics	QTY:6	
MODEL NO: T460HW03 V1		
PART NO: 97.46T03.XXX		
CUSTOMER NO:		
CARTON NO:		
Made in XXXXXX	*XXXXXXXX-XXXXXXXXXX*	



9. Precautions

Please pay attention to the followings when you use this TFT LCD module.

9-1 MOUNTING PRECAUTIONS

- (1) You must mount a module using holes arranged on back side of panel
- (2) You should consider the mounting structure so that uneven force (ex. Twisted stress) is not applied to module. And the case on which a module is mounted should have sufficient strength so that external force is not transmitted directly to the module.
- (3) Please attach the surface transparent protective plate to the surface in order to protect the polarizer. Transparent protective plate should have sufficient strength in order to resist external force.
- (4) You should adopt radiation structure to satisfy the temperature specification.
- (5) Acetic acid type and chlorine type materials for the cover case are not desirable because the former generates corrosive gas of attacking the polarizer at high temperature and the latter causes circuit break by electro-chemical reaction.
- (6) Do not touch, push or rub the exposed polarizers with glass, tweezers or anything harder than HB pencil lead. And please do not rub with dust clothes with chemical treatment. Do not touch the surface of polarizer for bare hand or greasy cloth. (Some cosmetics are detrimental to the polarizer.)
- (7) When the surface becomes dusty, please wipe gently with absorbent cotton or other soft materials like chamois soaks with petroleum benzene. Normal-hexane is recommended for cleaning the adhesives used to attach front/ rear polarizers. Do not use acetone, toluene and alcohol because they cause chemical damage to the polarizer.
- (8) Wipe off saliva or water drops as soon as possible. Their long time contact with polarizer causes deformations and color fading.
- (9) Do not open the case because inside circuits do not have sufficient strength.

9-2 OPERATING PRECAUTIONS

- (1) The spike noise causes the mis-operation of circuits. It should be lower than following voltage:
 $V = \pm 200\text{mV}$ (Over and under shoot voltage)
- (2) Response time depends on the temperature. (In lower temperature, it becomes longer.)
- (3) Brightness depends on the temperature. (In lower temperature, it becomes lower.) And in lower temperature, response time (required time that brightness is stable after turned on) becomes longer.
- (4) Be careful for condensation at sudden temperature change. Condensation makes damage to polarizer or electrical contacted parts. And after fading condensation, smear or spot will occur.
- (5) When fixed patterns are displayed for a long time, remnant image is likely to occur.
- (6) Module has high frequency circuits. Sufficient suppression to the electromagnetic interference shall be done by system manufacturers. Grounding and shielding methods may be important to minimize the interface.
- (7) The device listed in the product specification sheets was designed and manufactured for TV application.



9-3 ELECTROSTATIC DISCHARGE CONTROL

Since a module is composed of electronic circuits, it is not strong to electrostatic discharge. Make certain that treatment persons are connected to ground through wrist band etc. And don't touch interface pin directly.

9-4 PRECAUTIONS FOR STRONG LIGHT EXPOSURE

Strong light exposure causes degradation of polarizer and color filter.

9-5 STORAGE

When storing modules as spares for a long time, the following precautions are necessary.

- (1) Store them in a dark place. Do not expose the module to sunlight or fluorescent light. Keep the temperature between 5°C and 35°C at normal humidity.
- (2) The polarizer surface should not come in contact with any other object. It is recommended that they be stored in the container in which they were shipped.

9-6 HANDLING PRECAUTIONS FOR PROTECTION FILM

- (1) The protection film is attached to the bezel with a small masking tape. When the protection film is peeled off, static electricity is generated between the film and polarizer. This should be peeled off slowly and carefully by people who are electrically grounded and with well ion-blown equipment or in such a condition, etc.
- (2) When the module with protection film attached is stored for a long time, sometimes there remains a very small amount of glue still on the Bezel after the protection film is peeled off.
- (3) You can remove the glue easily. When the glue remains on the Bezel or its vestige is recognized, please wipe them off with absorbent cotton waste or other soft material like chamois soaked with normal-hexane.