

**PLEASE CHECK WWW.MOLEX.COM FOR LATEST PART INFORMATION**

**Part Number:** [0754334134](#)  
**Status:** **Active**  
**Overview:** [gbx\\_backplane\\_connector\\_system](#)  
**Description:** 1.85mm by 1.85mm (.073 by .073") Pitch 3-Pair GbX® Backplane Connector System, Right Guide Header, 60 Circuits, Gold (Au) 0.76µm (30µ"), Pin Length 4.55mm (.179")

**Documents:**

[Drawing \(PDF\)](#) [Product Specification PS-75221-999 \(PDF\)](#)  
[Packaging Specification \(PDF\)](#) [RoHS Certificate of Compliance \(PDF\)](#)

**Agency Certification**

UL E29179

**General**

Product Family Backplane Connectors  
 Series [75433](#)  
 Application Backplane  
 Application Tooling Documents [Tooling Manual](http://www.molex.com/pdm_docs/ats/TM-622022099.pdf)  
 Comments Right Guide Header, Keying Position C  
 Component Type PCB Header  
 Overview [gbx\\_backplane\\_connector\\_system](#)  
 Product Name GbX®  
 Style N/A

**Physical**

Circuits (Loaded) 60  
 Circuits (maximum) 60  
 Color - Resin Black  
 Durability (mating cycles max) 200  
 First Mate / Last Break No  
 Flammability 94V-0  
 Guide to Mating Part Yes  
 Keying to Mating Part Yes  
 Material - Metal High Performance Alloy (HPA), Stainless Steel  
 Material - Plating Mating Gold  
 Material - Plating Termination Tin-Lead  
 Material - Resin High Temperature Thermoplastic  
 Number of Columns 10  
 Number of Pairs 3  
 Number of Rows 6  
 Orientation Vertical  
 PC Tail Length (in) 0.087 In  
 PC Tail Length (mm) 2.20 mm  
 PCB Locator No  
 PCB Retention Yes  
 PCB Thickness Recommended (in) 0.063 In  
 PCB Thickness Recommended (mm) 1.60 mm  
 Packaging Type Tube  
 Pitch - Mating Interface (in) 0.073 In  
 Pitch - Mating Interface (mm) 1.85 mm  
 Pitch - Term. Interface (in) 0.073 In  
 Pitch - Term. Interface (mm) 1.85 mm  
 Plating min: Mating (µin) 30  
 Plating min: Mating (µm) 0.76  
 Plating min: Termination (µin) 30

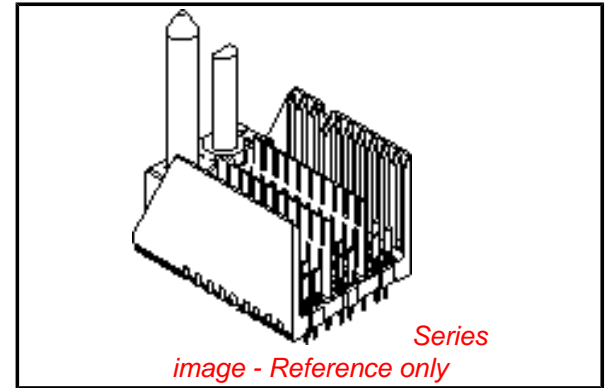

**EU RoHS**

**RoHS Compliant by Exemption**

**REACH SVHC**

Not Reviewed

**Halogen-Free**

**Status**

**Not Reviewed**

**China RoHS**



**Need more information on product environmental compliance?**

Email [productcompliance@molex.com](mailto:productcompliance@molex.com)  
 For a multiple part number RoHS Certificate of Compliance, [click here](#)

Please visit the [Contact Us](#) section for any non-product compliance questions.

**Search Parts in this Series**

[75433Series](#)

**Mates With**

[75370 GbX® Daughtercards](#)

**Application Tooling | FAQ**

*Tooling specifications and manuals are found by selecting the products below. Crimp Height Specifications are then contained in the Application Tooling Specification document.*

**Global**

Description	Product #
GbX® Single Pin Repair Tool	<a href="#">0622022090</a>
GbX® Shield Removal Tool	<a href="#">0622022100</a>
GbX® 3 Pair by 10 Wide Differential Insertion Tool	<a href="#">0622022510</a>

Plating min: Termination (µm)	0.76
Polarized to PCB	No
Stackable	No
Surface Mount Compatible (SMC)	Yes
Temperature Range - Operating	105°C
Termination Interface: Style	Through Hole - Compliant Pin

### **Electrical**

Current - Maximum per Contact	1A
Data Rate	8.0 Gbps
Real Signals (per 25mm)	81
Shield Type	Ground Plane Shield
Shielded	Yes
Voltage - Maximum	120V AC (RMS)/DC

### **Material Info**

#### **Reference - Drawing Numbers**

Packaging Specification	PK-70873-572
Product Specification	PS-75221-999
Sales Drawing	SD-75433-410

GbX is a registered trademark of Amphenol Corporation.

This document was generated on 05/14/2010

**PLEASE CHECK [WWW.MOLEX.COM](http://WWW.MOLEX.COM) FOR LATEST PART INFORMATION**

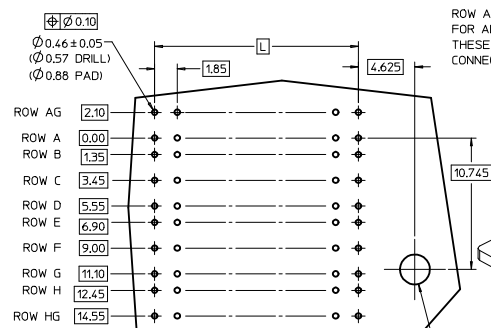
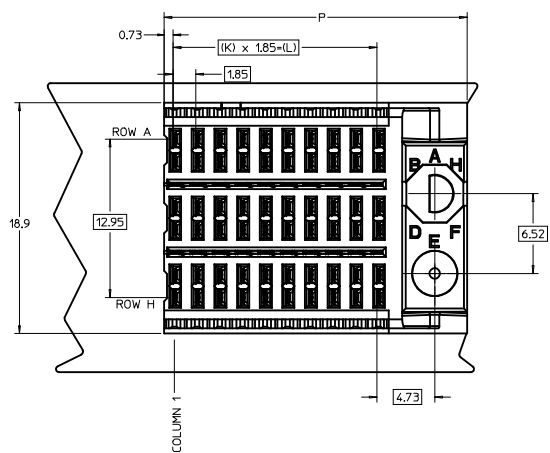

ROW AG & HG RECOMMENDED FOR ALL APPLICATIONS. THESE ROWS SHOULD BE CONNECTED TO GROUND.

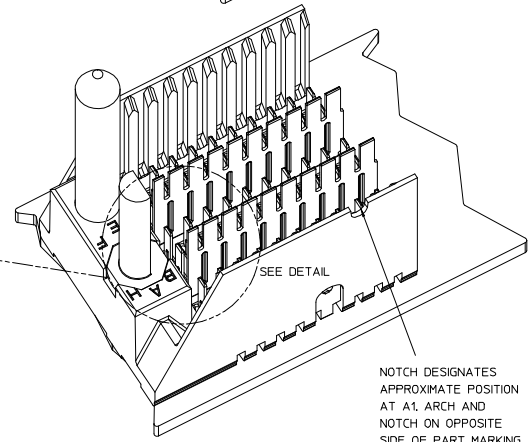
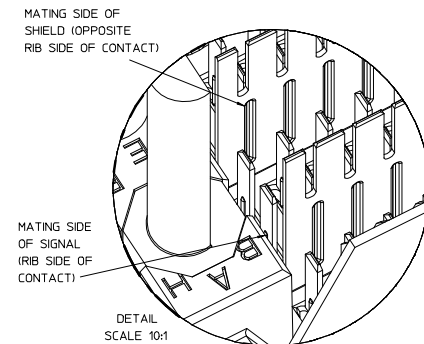
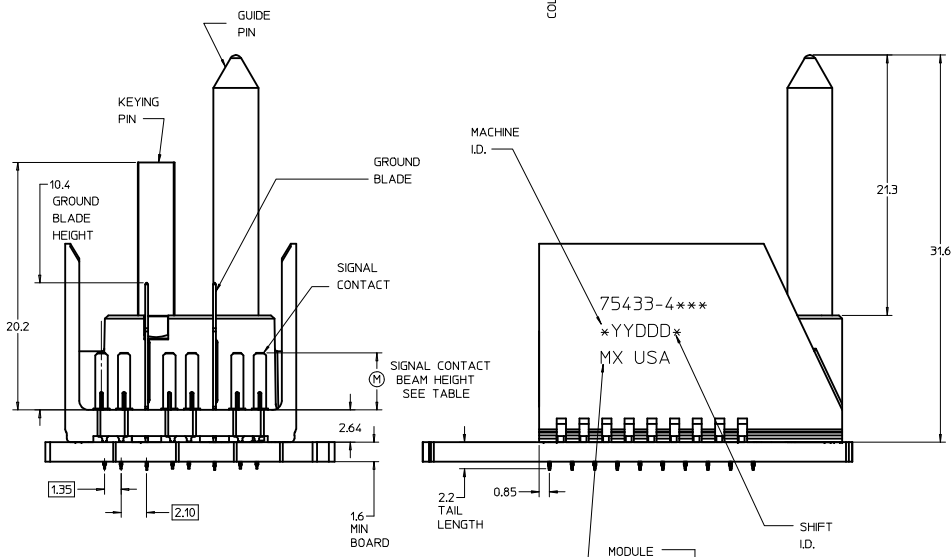
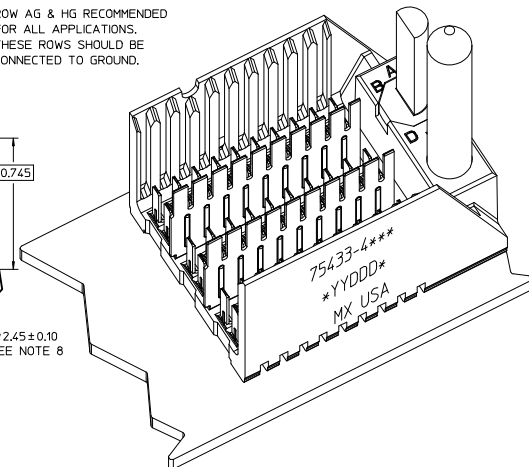

NOTES:

1. MATERIAL: HOUSING - LIQUID CRYSTAL POLYMER (LCP) GLASS-FILLED. UL 94V-0, COLOR - GRAY, SIGNAL CONTACT AND GROUND BLADE - HIGH PERFORMANCE COPPER ALLOY.
2. FINISHES: SELECTIVE GOLD (Au) ON CONTACT AREA. SELECTIVE TIN/LEAD (Sn/Pb) ON PCB TAILS. NICKEL (Ni) OVERALL.
3. THIS PART CONFORMS TO MOLEX PRODUCT SPECIFICATION PS-75221-999.
4. FOR MIXED CONTACT MATING LENGTHS CONSULT MOLEX FOR AVAILABILITY. CONTACT PAIRS MUST BE THE SAME LENGTH.
5. FOR SPECIFIC PART NUMBER AND MATING INFORMATION PLEASE REFER TO CHART.
6. PACKAGE PER PK-70873-572.
7. EITHER MARK PART NUMBER AND DATE CODE APPROXIMATELY WHERE SHOWN OR PLACE A LABEL ON THE TUBE.
8. OPTIONAL HOLE LOCATION FOR GROUNDED GUIDE PIN OR ADDITIONAL GUIDE PIN SUPPORT. FOR GROUNDED GUIDE PIN, HOLE TO BE PLATED, DRILL SIZE Ø2.58, PAD SIZE Ø5.50
9. THESE PARTS CONFORM TO MOLEX COSMETIC SPECIFICATION PS-45499-002 CLASS B.

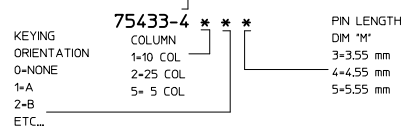

PART NUMBER TABLE				
ASSY PART NO.	K	L	P	TOTAL NO. OF DIFFERENTIAL PAIRS
75433-41**	9	16.65	24.78	30
75433-42**	24	44.40	52.53	75
75433-45**	4	7.40	15.53	15

P/N 75433-( )	--*0*	--*1*	--*2*	--*3*	--*4*	--*5*	--*6*	--*7*	--*8*
KEYING PIN ORIENTATION									

REVISED (MINOR) EC NO: UCP2009-1704 DRAWN: BINGHAM 2009/01/12 CHKD: CHIKD 2009/01/12 APPR: LAURX 2009/01/13 REV 1	QUALITY SYMBOLS -0 -0	GENERAL TOLERANCES (UNLESS SPECIFIED) .mm INCH		SCALE DIMENSION STYLE METRIC MM ONLY	DESIGN UNITS THIRD ANGLE PROJECTION	REVISE ON CAD ONLY		
		4 PLACES ± --- ± --- 3 PLACES ± --- ± --- 2 PLACES ± --- ± --- 1 PLACE ± --- ± --- ANGULAR ± ---°		DRAWN BY NMARTIN 2005/02/20	DATE 2005/02/20	TITLE GBX 3-PAIR RIGHT END BACKPLANE SALES ASSEMBLY		
		DRAFT WHERE APPLICABLE MUST REMAIN WITHIN DIMENSIONS		CHECKED BY SREED 2005/02/20	DATE 2005/02/20	MATERIAL NO. SEE CHART	DOCUMENT NO. SD-75433-410	SHEET NO. 1 OF 1
		THIS DRAWING CONTAINS INFORMATION THAT IS PROPRIETARY TO MOLEX INCORPORATED AND SHOULD NOT BE USED WITHOUT WRITTEN PERMISSION						