

FIP STATIC DISPLAY DRIVER CMOS LSI

DESCRIPTION

μ PD6700 is a CMOS display driver which can directly drive a static display fluorescent indicator panel (FIP). It is a small 56 pin flat package and composed of a 48 bit shift register, latch circuit, dimmer circuit and LED dot driver. It is optimum for a static display driver for fluorescent indicator panel (FIP) use, such as a counter display in compact disk (CD) player as well as a frequency display and a clock display in automotive audio system.

FEATURES

- A small 56 pin Flat package (0.8 mm pin pitch) capable of easily installing in front panel of automotive audio system.
- 2 power sources
 - Power for Logic use (LED driver): $V_{DD} = 5\text{ V} \pm 10\%$
 - Power for display driver (FIP driver): V_{DD} to 18 V
- FIP drive by only positive power ($V_{FIP} = 18\text{ V MAX.}$)
- Direct connection with FIP (CMOS Push-pull output: No use of external resistances)
- Dimmer control (by ON/OFF terminal)
- Built-in power-on reset circuit (the display automatically turns out reset)
- Powerful segment output (47 segments MAX.): 1 mA TYP./seg.
- Dot display of 10 points by LED (selected by LED/FIP terminal): 15 mA TYP./seg.
At LED/FIP = 1, it is capable of dot display of 10 points in addition to 37 FIP segment display (and capable of lighting MAX. 3 points at the same time).
- Cascade connection (with data output terminal)
Easy control by microprocessor incorporating a serial interface function (data transmission per 8-bit unit)

ORDERING INFORMATION

Part Number	Package	Quality Grade
μ PD6700GH-3B7	56-pin plastic QFP (10 × 14)	Standard

Please refer to "Quality grade on NEC Semiconductor Devices" (Document number IEI-1209) published by NEC Corporation to know the specification of quality grade on the devices and its recommended applications.

BLOCK DIAGRAM

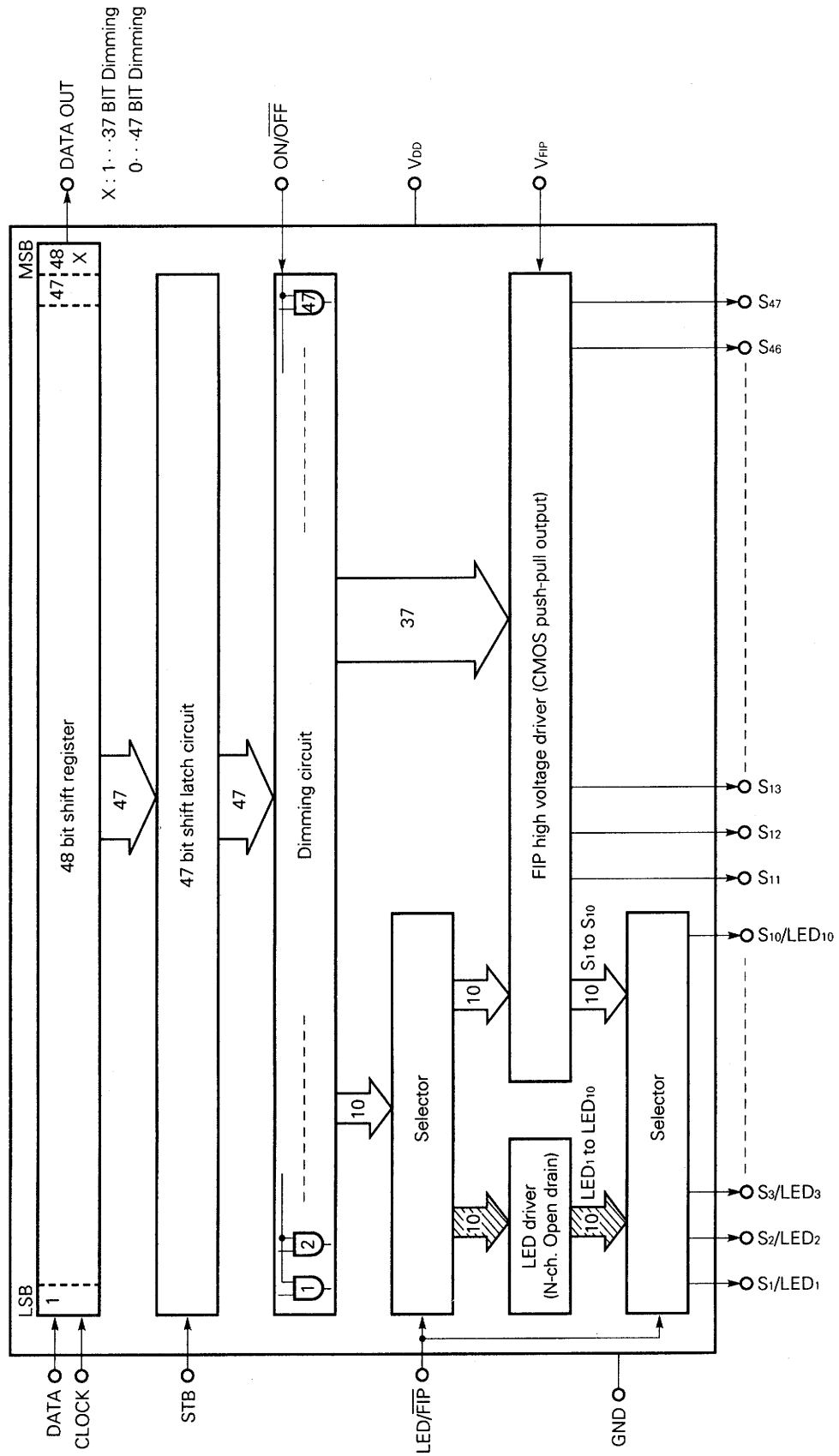

PIN CONNECTION DIAGRAM (Top View)

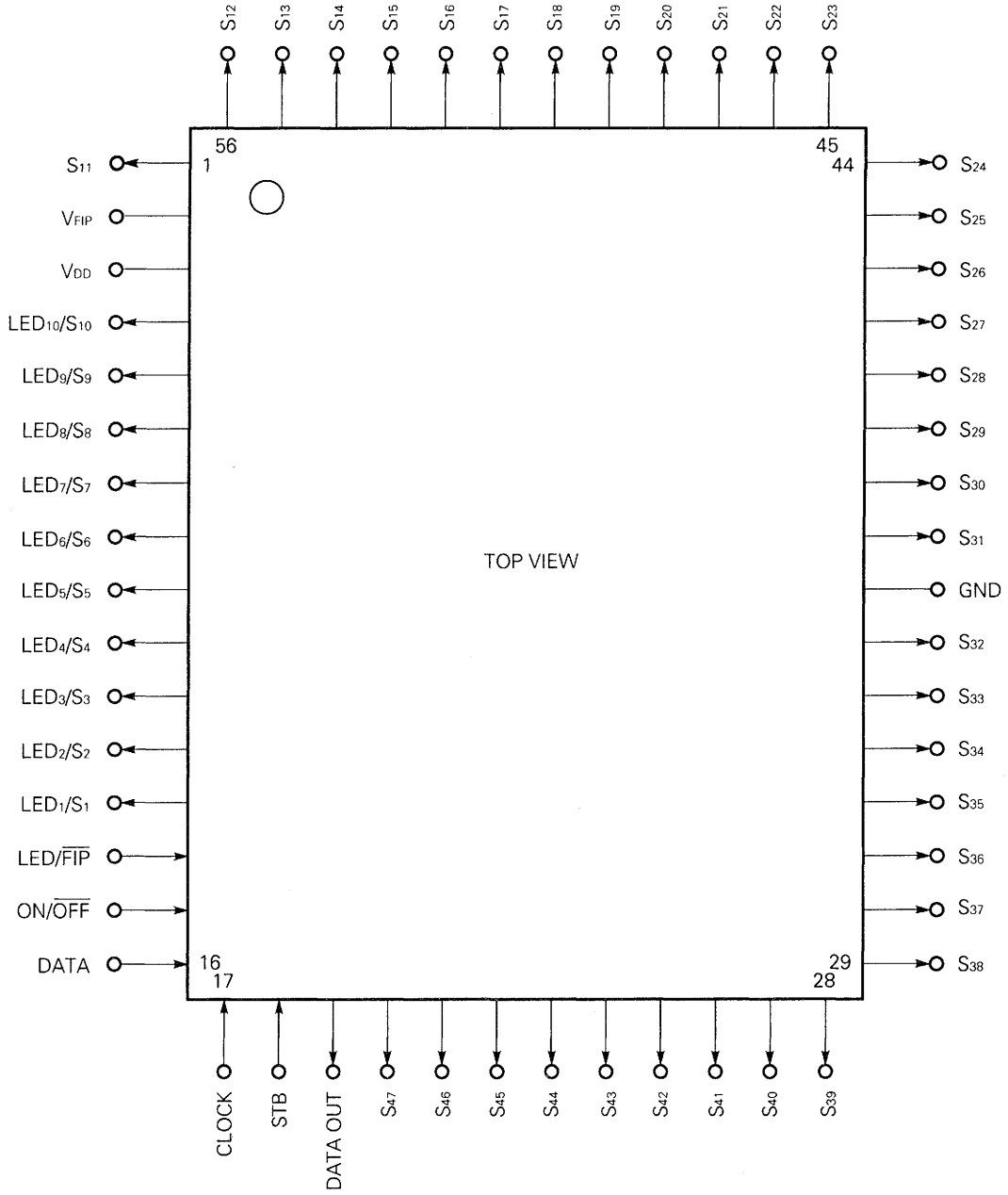

EXPLANATION OF MAIN PIN FUNCTION

- DATA/CLOCK : Pin 16/17

These are data input Pins to shift register. At the rising edge of clock Pin 17, data are shifted by one bit.

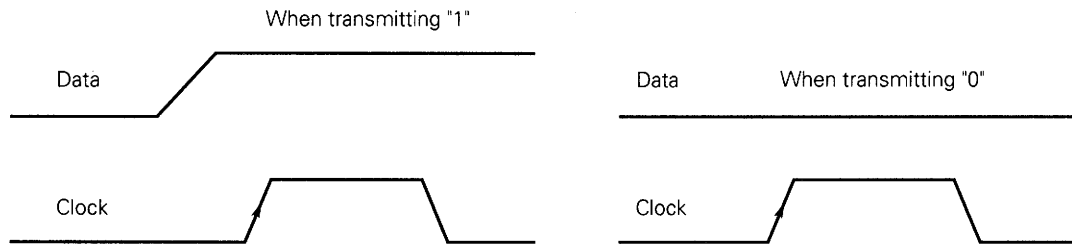

Display data are shifted from the 48th bit in order, and data transmission finishes when the 1st bit (LSB) Display datum is transmitted.

If display is changed, 48-bits data and clocks shall be transmitted necessarily.

- STB : PIN 18

At the rising edge of STB Pin 18, Shift register (48 bits) data and clocks are transmitted to Latch circuit and display are performed.

When Pin 18 is between high level and low, Latch circuit holds previous data regardless of Shift register data.

Therefore, it is not until Pin 18 changes low to high that Display data change.

- LED/FIP : PIN 14

It is a selection Pin which switches all of 47 driver Pins to FIP driver or a part (10) of them to LED driver.

High Level 10 LED (S₁ to S₁₀) Drivers and 37 FIP Drivers

Low Level (S₁ to S₄₇) All FIP drivers

- ON/OFF : PIN 15

While this Pin is high, Display data are output.

While low, output is off.

This Pin is used as dimming by PWM signal input.

- DATA OUT : PIN 19

This is a cascade-connection Pin, capable of connecting with another μPD6700GH's data input.

(Cautions)

To prevent latch up break down, the power should be turned ON in the order, V_{DD}, logic signal, V_{FIP}. It should be turned OFF in the opposite order.

ABSOLUTE MAXIMUM RATINGS (T_a = 25 °C)

PARAMETER	SYMBOL	RATINGS	UNIT	TEST CONDITIONS
Power supply voltage	V _{DD}	-0.3 to +6.0	V	
FIP drive voltage	V _{FIP}	-0.3 to +20	V	
Input voltage	V _I	-0.3 to V _{DD} +0.3	V	
Output current	I _{OLED}	25	mA	LED drive port
Output current High	I _{OH1}	-10	mA	FIP drive port
Output current Low	I _{OL}	+10	mA	FIP drive port
Output current High	I _{OH2}	-50	mA	Total FIP drive port
Power Consumption	P _D	300	mW	
Operating Temperature	T _{opt}	-40 to +85	°C	
Storage Temperature	T _{stg}	-55 to +125	°C	

RECOMMENDED OPERATING CONDITIONS

PARAMETER	SYMBOL	MIN.	TYP.	MAX.	UNIT	TEST CONDITIONS
Power supply voltage	V _{DD}	4.5	5.0	5.5	V	
FIP drive voltage	V _{VIP}	V _{DD}	12	18	V	
Input voltage High	V _{IH}	0.7 V _{DD}		V _{DD}	V	DATA, CLOCK, STB, LED/FIP, ON/OFF
Input voltage Low	V _{IL}	0		0.3 V _{DD}	V	DATA, CLOCK, STB, LED/FIP, ON/OFF
LED port output current	I _{OLED}		10	20	mA	
FIP port output current	I _{OFIP}		0.5	1.0	mA	
V _{DD} rising time	t _{ur}			200	MS	from V _{DD} = 0 V to 0.7 V _{DD}

ELECTRICAL CHARACTERISTICS (T_a = -40 to +85 °C, V_{DD} = 5 V ± 10 %, V_{FIP} = 15 V)

PARAMETER	SYMBOL	MIN.	TYP.	MAX.	UNIT	TEST CONDITIONS
Output voltage 1 High	V _{OH1}	V _{FIP} -1.0	V _{FIP} -0.4		V	S ₁ to S ₄₇ , I _o = -1 mA
Output voltage 2 High	V _{OH2}	V _{DD} -0.5	V _{DD} -0.2		V	DATA OUT, I _o = -0.5 mA
Output voltage 1 Low	V _{OL1}		0.2	0.5	V	S ₁ to S ₄₇ , I _o = 1 mA
Output voltage 2 Low	V _{OL2}		0.2	0.5	V	DATA OUT, I _o = 0.5 mA
Output voltage 3 Low	V _{OL3}		1.0	1.4	V	LED ₁ to LED ₁₀ , I _o = 20 mA
Input leak current	I _I			±10	μA	DATA, CLOCK, STB, ON/OFF, LED/FIP, V _I = V _{DD} or V _{SS}
Output leak current 1	I _{LO1}			±10	μA	LED ₁ to LED ₁₀ , V _o = 0 V
Output leak current 2	I _{LO2}			±10	μA	LED ₁ to LED ₁₀ , V _o = 5 V
Supply current	I _{DD}			0.1	mA	V _I = V _{DD} or V _{SS}

SWITCHING CHARACTERISTICS (T_a = -40 to +85 °C, V_{DD} = 5 V ± 10 %, V_{FIP} = 15 V)

PARAMETER	SYMBOL	MIN.	TYP.	MAX.	UNIT	TEST CONDITIONS
Clock Frequency	f _{CLK}			1.0	MHz	
Data out delay time	t _{PD}			500	ns	for CLOCK ↑
Data out hold time	t _{DOH}	200			ns	

SWITCHING CHARACTERISTICS (T_a = -40 to +85 °C, V_{DD} = 5 V ± 10 %, V_{FIP} = 15 V)

PARAMETER	SYMBOL	MIN.	TYP.	MAX.	UNIT	TEST CONDITIONS
Clock Rising Time	t _r			1.0	μs	
Clock Falling Time	t _r			1.0	μs	
Clock Pulse Width	PW _{CLK}	400			ns	
Strobe Pulse Width	PW _{STB}	400			ns	
Data Set-up Time	t _{DIS}	200			ns	for CLOCK ↑
Data Hold Time	t _{DIH}	100			ns	for CLOCK ↑
Clock Set-up Time	t _{CS}	500			ns	for STB ↑

SWITCHING TIMING

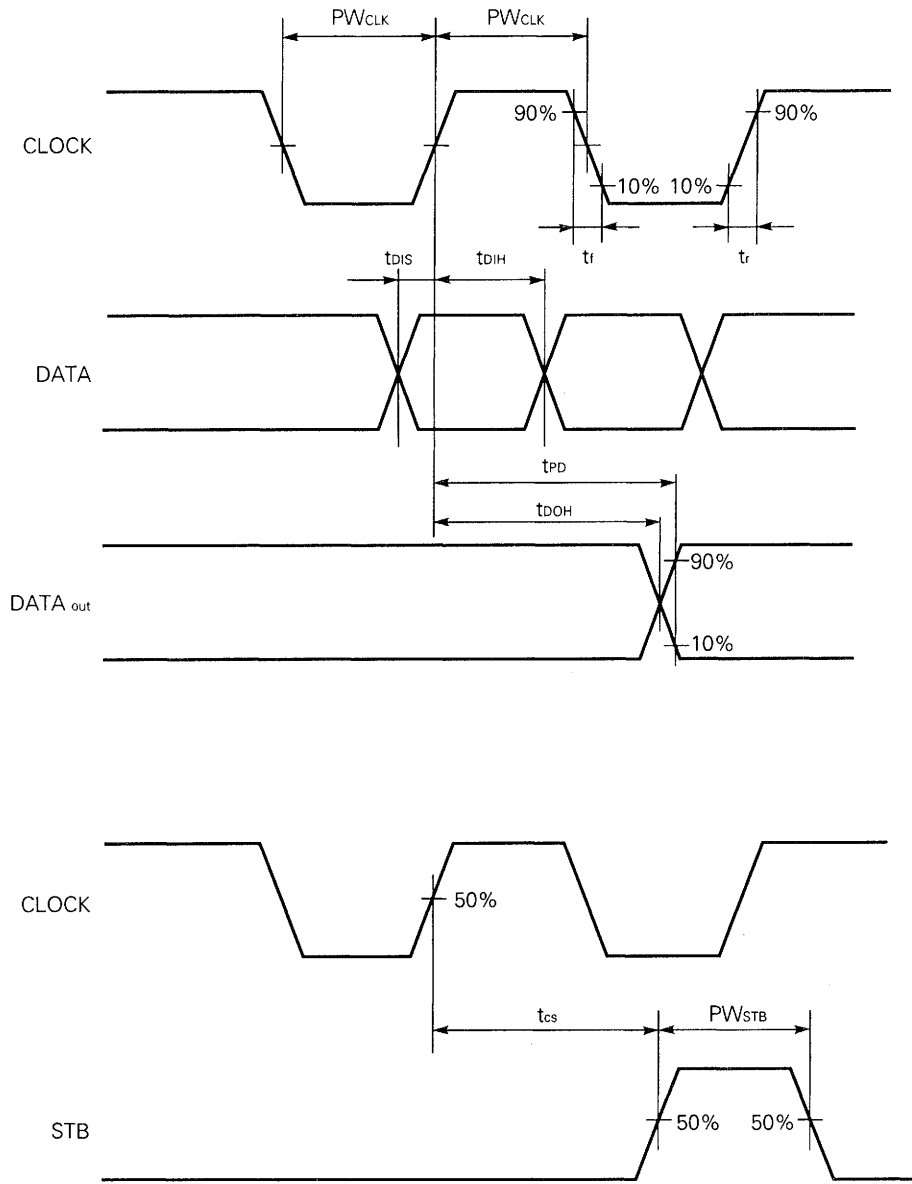

TIMING CHART

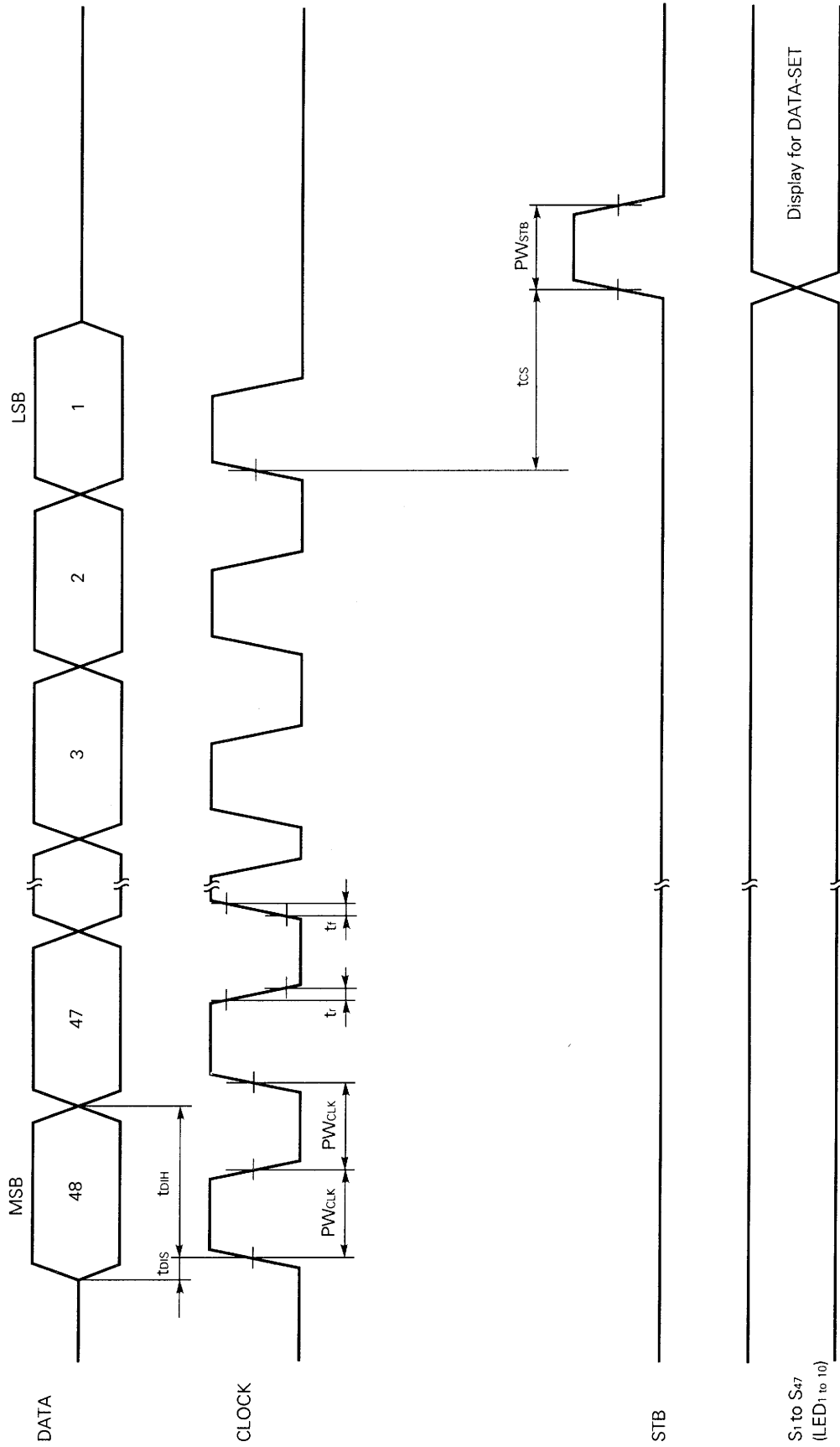

APPLICATION CIRCUIT (AUTOMOTIVE AUDIO BLOCK DIAGRAM)

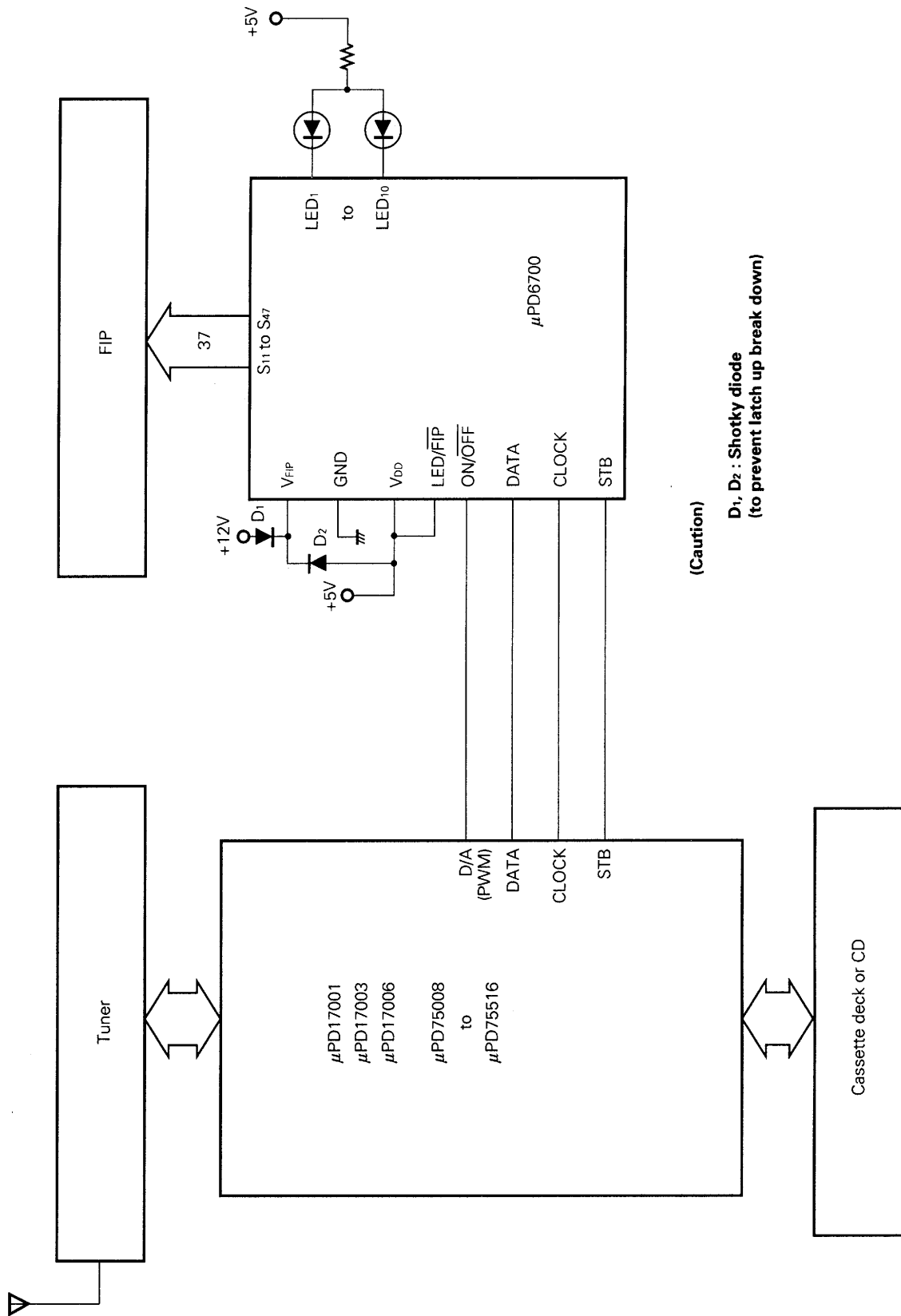

56 PIN PLASTIC QFP (10 × 14)

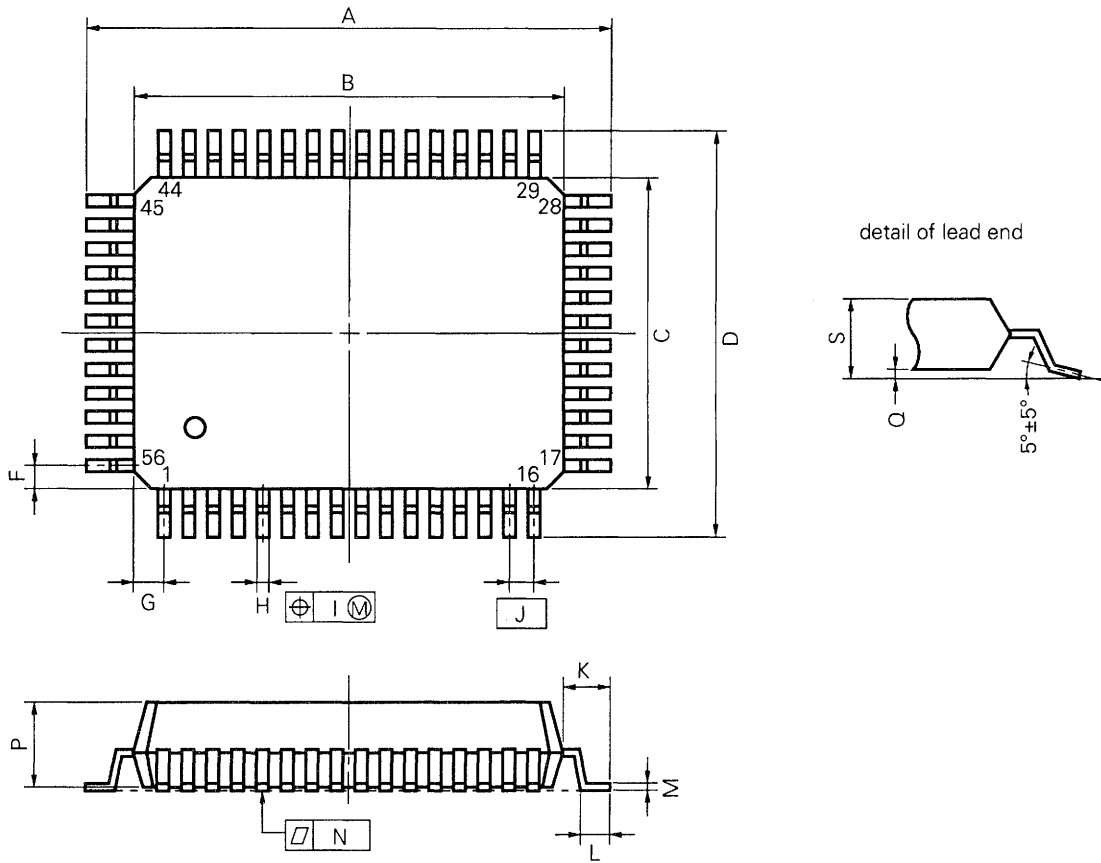

NOTE

Each lead centerline is located within 0.15 mm (0.006 inch) of its true position (T.P.) at maximum material condition.

S56GH-80-3B7-1

ITEM	MILLIMETERS	INCHES
A	17.2±0.4	0.677±0.016
B	14.0±0.2	0.551 ^{+0.009} _{-0.008}
C	10.0±0.2	0.394 ^{+0.008} _{-0.009}
D	13.2±0.4	0.520±0.016
F	0.6	0.024
G	1.0	0.039
H	0.35±0.10	0.014 ^{+0.004} _{-0.005}
I	0.15	0.006
J	0.8 (T.P.)	0.031 (T.P.)
K	1.6±0.2	0.063±0.008
L	0.8±0.2	0.031 ^{+0.009} _{-0.008}
M	0.15 ^{+0.10} _{-0.05}	0.006 ^{+0.004} _{-0.003}
N	0.15	0.006
P	2.7	0.106
Q	0.1±0.1	0.004±0.004
S	3.0 MAX.	0.119 MAX.

RECOMMENDED SOLDERING CONDITIONS

The following conditions (see table below) must be met when soldering this product. Please consult with our sales offices in case other soldering process is used, or in case soldering is done under different conditions.

TYPES OF SURFACE MOUNT DEVICE

For more details, refer to our document "Semiconductor Device Mounting Technology Manual" (IEI-1207).

μPD6700GH-3B7

Soldering process	Soldering conditions	Symbol
Infrared ray reflow	Peak package's surface temperature: 230 °C or below, Reflow time: 30 seconds or below (210 °C or higher), Number of reflow process: 1, Exposure limit*: None	IR30-00-1
VPS	Peak package's surface temperature: 215 °C or below, Reflow time: 40 seconds or below (200 °C or higher), Number of reflow process: 1, Exposure limit*: None	VP15-00-1
Partial heating method	Terminal temperature: 300 °C or below, Flow time: 10 seconds or below, Exposure limit*: None	

* Exposure limit before soldering after dry-pack package is opened.
Storage conditions: 25 °C and relative humidity at 65 % or less.

Note Do not apply more than a single process at once, except for "Partial heating method".

Reference

[Quality Grades On NEC Semiconductor Devices] (IEI-1209)

[NEC Semiconductor Device Reliability/Quality Controls] (IEI-1206)

[MEMO]

No part of this document may be copied or reproduced in any form or by any means without the prior written consent of NEC Corporation. NEC Corporation assumes no responsibility for any errors which may appear in this document.

NEC Corporation does not assume any liability for infringement of patents, copyrights or other intellectual property rights of third parties by or arising from use of a device described herein or any other liability arising from use of such device. No license, either express, implied or otherwise, is granted under any patents, copyrights or other intellectual property rights of NEC Corporation or others.

The devices listed in this document are not suitable for use in aerospace equipment, submarine cables, nuclear reactor control systems and life support systems. If customers intend to use NEC devices for above applications or they intend to use "Standard" quality grade NEC devices for applications not intended by NEC, please contact our sales people in advance.

Application examples recommended by NEC Corporation

Standard: Computer, Office equipment, Communication equipment, Test and Measurement equipment, Machine tools, Industrial robots, Audio and Visual equipment, Other consumer products, etc.

Special: Automotive and Transportation equipment, Traffic control systems, Antidisaster systems, Anticrime systems, etc.